

Talentum® I6589-20

IR³ Flame Detector

The Talentum® triple Infra-Red (IR³) Flame Detector is designed to protect areas where open fires may be expected and detects almost all flames, including hydrocarbon fires with 4.3 μm emissions through to invisible fires such as hydrogen.

The IR³ Flame Detector is sensitive to flickering, low frequency (1- 15Hz) infra-red radiation emitted by flames during combustion even if the lens is contaminated by a layer of oil, dust, water, vapour or ice.

This detector has three IR sensors which respond to different IR wavelengths in order to discriminate between flames and spurious sources of radiation. False alarms from flickering sunlight are avoided by a combination of filters and signal processing techniques.

The Talentum® IR³ detector has selectable output options of relay contacts or 4-20mA signal, as standard..

Features

- Excellent immunity to false sources
- Tolerant of fumes, vapours, dust and mist
- Suitable for indoor and outdoor areas
- Unaffected by convection currents, draughts or wind
- Proven response to multiple fuel types
- Multi-spectrum detection
- Selectable output options
- Selectable response speed
- Selectable sensitivity levels
- Built in auto and manual test
- Low current consumption
- Fast response to fire



Applications

- Refineries
- Compressor Stations
- Fuel Loading Racks
- Chemical Plants
- Tunnels
- Waste Recycling
- Nuclear Power Sites
- Storage Tanks
- Engine Rooms
- Spray Booths
- Pharmaceutical Production
- Military Applications
- Marine Industry
- Aircraft Hangars
- Coal Handling
- Printing
- Petrochemical Offshore/ Onshore
- LNG/LPG Production
- Biomass Storage and Handling

Accessories

- 07127 Stainless Steel Adjustable Mount (316)
- 12545 Stainless Steel Weather Shield (316)
- 16091 Portable Flame Detector Tester



FM Approved

Visit www.ffeu.com for up to date approvals information.

Class I, Div. I, Groups A, B, C, D T4, IP66
 Class I, Zone I, AEx db IIC Gb T4, IP66
 Class II/III, Div. I, Groups E, F, G T4, IP66



Talentum® I6589-20

Mechanical Specification

Housing Material	Die Cast Zinc Alloy (ZA12)
Housing Colour	Blue
Dimensions	5.91"H x 5.75"W x 5.39"D (142(H) x 108(W) x 82(D) mm)
Weight	5.5 lbs (2kg)
Cable Gland Entries	3 x 0.79" (2 x 20 mm)
Wiring	1.0 to 4.0mm ²

Electrical Specification

Supply Voltage	14 to 30Vdc
Quiescent Current	8mA, RL2 energised 4mA, current loop, RL2 off 3mA, RL2 off
Alarm Current	28mA, RL1 & RL2 energised 20mA, current loop, RL1 & 2 off 9mA, RL1 energised
Power Up Time	2 seconds max.
Test Signal Voltage	14 to 30Vdc
Relay Outputs	Normally Open or Normally Closed
- Programmable	Latching or Non-latching
- Ratings:	Current 1.0A Max. Voltage 50Vdc Max. Power 30W Max. (Note: Resistive Loads Only)

Environmental

Operating Temperature	-20°C to +60°C
Storage Temperature	-20°C to +125°C
Relative Humidity	95% Non condensing
IP Rating I	IP66

Performance

Range - Class I*	0.1m ² n-heptane at 25m
- Class 3	0.1m ² n-heptane at 12m (see EN54:10 for sensitivity settings)
Field of View	90° min. Cone
Operating Wavelength	
Band - IR	0.75 to 2.7µm

Approvals

FM Approved	Cert. No. 3059453
CPR	0832-CPR-F0583
LPCB	1204a/11
VdS	G212189
SIL 2	C127_CT003_(2.0)

Response Characteristics – High Sensitivity

Fuel	Flame Size m (ft)	Certified Distance m (ft)	Factory Tested Distance m (ft)	Average Response time @ 25m (Seconds)
n-Heptane* (Yellow flame)	0.3 x 0.3 (1 x 1)	25 (82)	60 (196)	16
Methylated Spirit* (Clear flame)	0.5 x 0.5 (1.6 x 1.6)	25 (82)		
Hydrogen (non- visible flame)	0.1 x 0.5 (0.3 x 1.6)	12 (39)		

* has been tested and approved at Class I

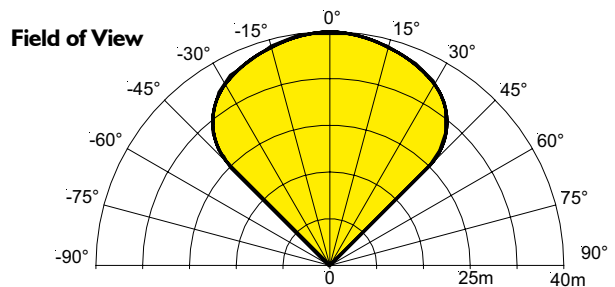

To meet the requirements of EN54:10 clause 5.4, where the ratio of the response points Dmax: Dmin should not exceed 1.41, the horizontal and vertical viewing angles max should not exceed ±30°.

Flame Detector

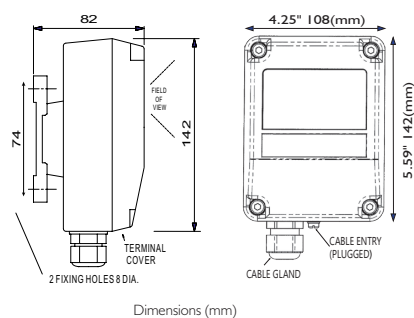

Mounting Bracket

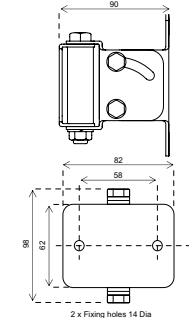

Installation Recommendations

Please refer to our User Manual for mounting and wiring instructions. The installation of Talentum® flame detectors should be undertaken in accordance with the recognised national or international standards and codes of practice.

Specifications and wiring information are provided for information only and are believed to be accurate. FFE Ltd assumes no responsibility for their use. Data and design are subject to change without notice. Installation and wiring instructions are shipped with the products and should always be used for actual installation. For more information, contact your Sales Representative.

Document Part No: 24-0186-02



US Sales and Distribution
FFE Limited
1455 Jamike Ave Ste 200, Erlanger KY 41018-3147 USA

t +1 (859) 957 1570
e america@ffeuk.com
w www.ffeuk.com

www.ffeuk.com