



## PolyGuard® Controller MGC2-20

### Multi-Point Controller Serial Number – S00 User Manual

September 29, 2011

November 19, 2013 – *Revision*

<b>1</b>	<b>Description</b> .....	<b>4</b>
<b>2</b>	<b>Operating Instruction</b> .....	<b>5</b>
2.1	Description Keypad User Interface .....	5
2.2	Setting / Change Parameters .....	5
2.3	Password Level .....	6
<b>3</b>	<b>Menu Overview</b> .....	<b>7</b>
3.1	Malfunction management .....	8
3.1.1	Acknowledge a malfunction .....	8
3.1.2	History error summary .....	8
3.1.3	System Errors.....	9
3.2	Stage Status.....	9
3.3	Relay Status .....	9
3.3.1	Manual operation of the relays .....	10
3.4	Menu Sensor Readings .....	10
3.5	Menu Relay Setup .....	11
3.5.1	Relay Mode .....	11
3.5.2	Relay Action Steady / Flash.....	11
3.5.3	Latching Mode.....	12
3.5.4	Horn Function.....	12
3.5.5	External operation of Relay .....	13
3.5.6	Delay operation of Relay .....	13
3.6	Menu SP Setup .....	14
3.6.1	Activate – Deactivate SP .....	15
3.6.2	Selection Type.....	16
3.6.3	Measuring range.....	16
3.6.4	SP Signal.....	16
3.6.5	Stage/Setpoint / Hysteresis .....	17
3.6.6	Delay time ON or OFF .....	17
3.6.7	Control Mode.....	17
3.6.8	Assigned SP Fault to Relay .....	17
3.6.9	Assign Relay to a Stage .....	18
3.6.10	Assigned SP Signal to analog Output.....	18
3.7	Menu System Setup .....	19
3.7.1	Service Mode .....	20
3.7.2	Software Version .....	21
3.7.3	Maintenance Concept.....	21
3.7.4	Average Value Function .....	21
3.7.5	Time, Date.....	21
3.7.6	Customer Password (Code 1) .....	22
3.7.7	Analog Output .....	22
3.7.8	Define the Failure Relay .....	22
3.7.9	Power On Time .....	22
3.7.10	Activation of expansions modules.....	23
<b>4</b>	<b>Mounting / Electrical Connection</b> .....	<b>24</b>
4.1	Electrical Connection.....	24
4.2	Unit position – Connection diagram .....	25

<b>5</b>	<b>Start-up Operation .....</b>	<b>29</b>
5.1	Start-up.....	29
5.2	Checklist Start-up operation .....	30
<b>6</b>	<b>Configuration- and Parameter card.....</b>	<b>31</b>
6.1	Configurations System Setup .....	31
6.2	Relay Setup.....	32
6.3	Sensor Setup.....	33
<b>7</b>	<b>Specifications MGC2-20 .....</b>	<b>34</b>
<b>8</b>	<b>Notes and General Information.....</b>	<b>36</b>
8.1	Intended product application.....	36
8.2	Installers` responsibilities.....	36
8.3	Maintenance.....	36
8.4	Limited warranty .....	36

## **Multi Point Controller MGC2**

### **1 Description**

The PolyGard® Multi Point Controller MGC2 is used for the monitoring and warning of sensor points exceeding their stage setpoints. External Transmitters can monitor and warn of toxic, combustible and refrigerant gases as well as temperature and humidity. The Controller MGC2 can measure up to twenty analog 4 to 20 mA (Gas) Transmitters.. Each Sensor Point (SP) can have five stage thresholds. Each stage threshold can be assigned to anyone of the relays (R1...R20). The Controller can interface via ten 4 to 20 mA outputs to any compatible electronic analog control, DDC/PLC control or automation system.

The adjustable parameters and staged thresholds make this system very flexible for sensor measuring and control.

The configuration of parameter settings and operation is easy to do without any programming knowledge.





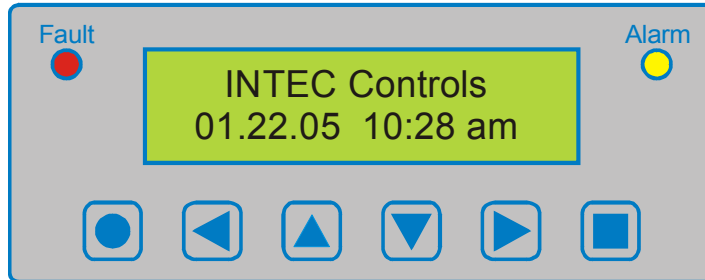

PolyGard® Multi Point Controller MGC2 must not be used in areas requiring explosion proof equipment.

## 2 Operating Instruction

The complete configuration, parameterization and service are made via the keypad user interface in combination with the display screen. Security is provided via two password levels.



### 2.1 Description Keypad User Interface







-  Exits programming and saves settings, returns to the previous menu level.
-  Enter sub menus, stores changed values.
-   Scrolls down & up in Main menu and Sub menus, increases or decreases a value.
-   Moves cursor left or right.

LED yellow Flashes when one or more stages have been exceeded or steady if the operator has manually overridden any relays.

LED red: Flashes when a System or Sensor Failure is detected or when the Maintenance Date is needed.

### 2.2 Setting / Change Parameters

Desired menu window open.

-  Opens menu window, if the password is approved the cursor jumps to the first segment position
-   Moves the cursor right or left to a segment position
-   Changes the parameter or value
-  Saving the changed parameter or value.  
Finish

### **2.3 Password Level**

All changes of parameters and staged setpoint values are protected by four digit numeric Code (= password).

The code level 1 permits the operation of the MGC2. This code level is intended for the customer. It can be changed in the System Setup Menu "Change Customer Password"

With the code level 2 all parameters and set points can be changed, this code level is reserved for the service technician.

A password must be re-entered if there is 15 minutes of inactivity.

All menu windows are visible without a password.

Factory preprogrammed system password "9001".

### 3 Menu Overview

The Multi-Point Controller MGC2 is operated via a simple and logical menu structure which is easy to learn. The operating menu contains the following levels:

- Starting menu with date and time if no SP is registered, otherwise scrolling display of the gas concentrations of all registered transmitters in 5-second intervals
- Main menu
- Submenu 1 and 2

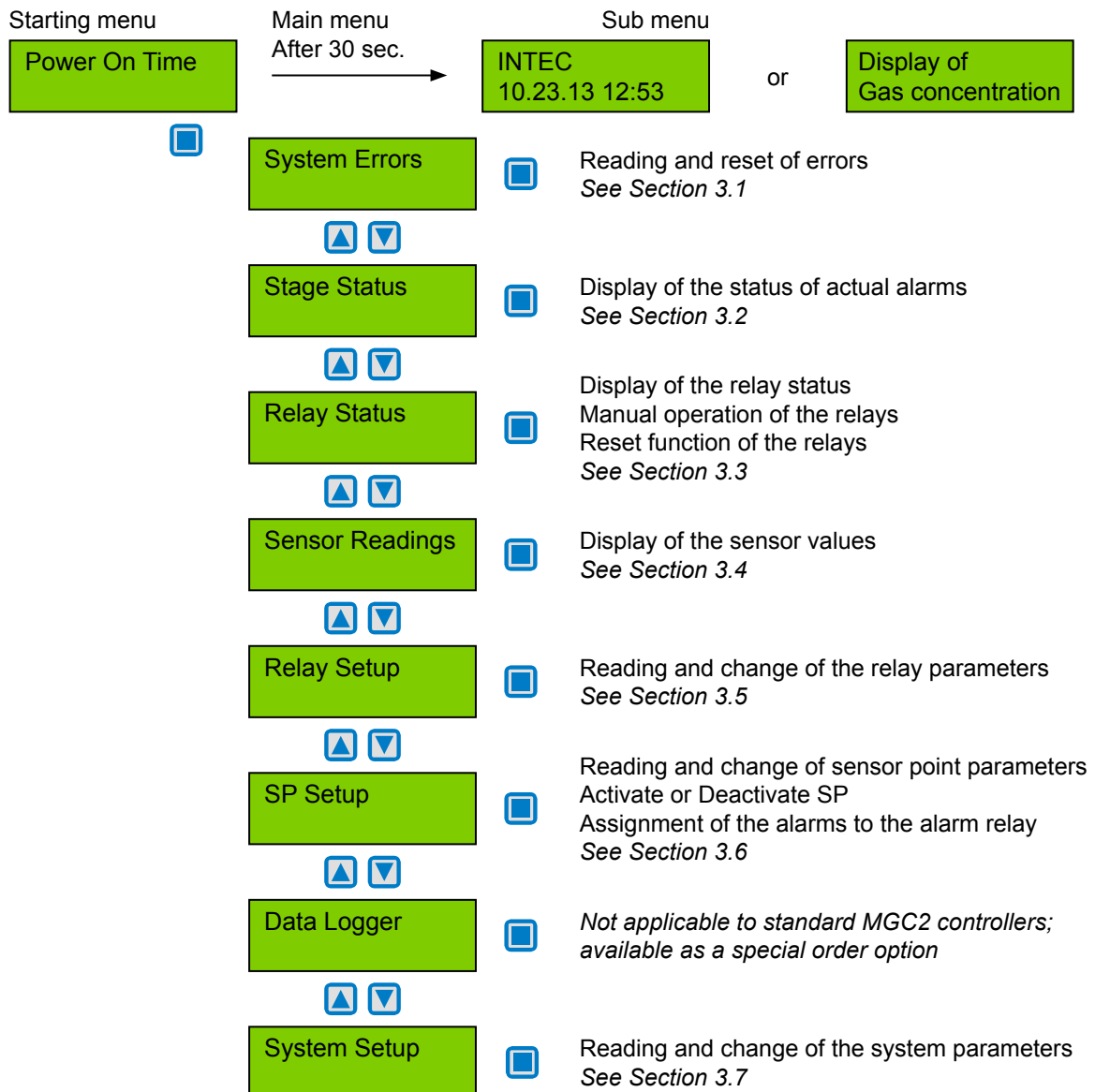

**3.1 Malfunction management**

Malfunction management records the last 15 malfunctions with date and time stamps. In addition, “System Errors” are recorded in “Error Memory” when the malfunction occurs. This history can be selected and cleared only by the service technician level 2 password.

A malfunction will display a text message in the Starting Menu. When a failure occurs the relay defined in the system setup as “Failure relay” is activated. The red LED in the front of the Controller flashes.

During the malfunction of a sensor point (SP) stages that are assigned for sensor failure are activated. Relays that are assigned to these stages perform as if the stage has been exceeded. These assignments are programmed in the menu “SP Setup”.

**3.1.1 Acknowledge a malfunction**

*Note:*

Resetting a malfunction is only possible if the problem is corrected.

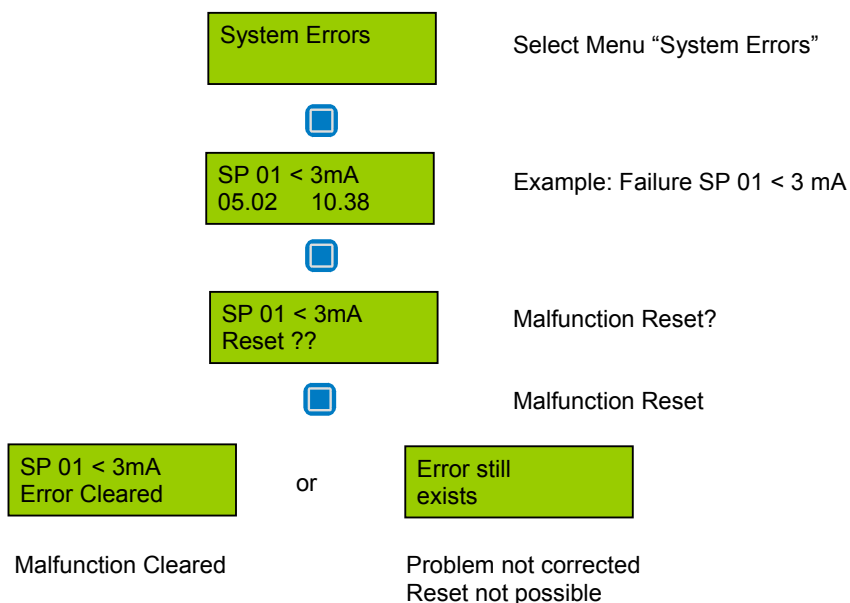

**3.1.2 History error summary**

The code level 2 password can open the menu “Hist Error Sum” in the main menu “System Errors”.

The last 15 error messages are listed for the service technician even if they have already been reset. These error messages can be deleted individually



**3.1.3 System Errors**

System Error Messages:

- SP XX > 22 mA**                      Current signal at analog Input XX > 22 mA.  
     Cause:                                Short-circuit at analog Input or Transmitter not calibrated, Transmitter defective.  
     Solution:                             Check cable to Transmitter, Perform Calibration, Change the Transmitter.
- SP XX < 3 mA**                      Current signal to analog Input XX < 3 mA.  
     Cause:                                Open circuit at analog Input or Transmitter not calibrated, Transmitter defective.  
     Solution:                             Check cable to Transmitter, Perform Calibration, Change the Transmitter.
- GC Error:**                            Internal Communication Error I/O Board to LCD Board.  
     Cause:                                Internal Error.  
     Solution:                             Change the Controller.
- EP 0X Com Error:**                Communication error to expansion module (EP 0X).  
     (Only active, if EP module announced).  
     Cause:                                EP module address not correct. (See Start up Operation 5.0)  
     Bus cable to EP 0X module disconnected.  
     No power supply at the EP 0X module.  
     EP module defective.  
     Solution:                             Check the EP module address.  
     Check the bus cable and the power supply.  
     Change the EP 0X module.
- Maintenance:**                      System maintenance is necessary.  
     Cause:                                Maintenance date exceeded.  
     Solution:                             Perform maintenance.

**3.2 Stage Status**

Displays the actual stages exceeded in the sequence that they happen. The sensor point displays with the stages that have been exceeded. Changes can not be made in this menu.

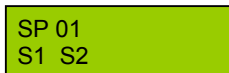

Symbol	Description	Function
SP 01	Sensor Point (SP) No.	
SX	Stage Status	S1 = Stage 1 ON S2 = Stage 2 ON S3 = Stage 3 ON S4 = Stage 4 ON S5 = Stage 5 ON

**3.3 Relay Status**

Display the actual status of each relay and changes can be made for manual operation of the relays.



Symbol	Description	Setting Status	Function
R 01	Relay No. 01		Select Relay No.
OFF	Status Relay	OFF	OFF = Relay Off (Not Activated by Stage Setpoint) ON = Relay On (Activated by Stage Setpoint) Manual OFF = Relay manual Off Manual ON = Relay manual On

**3.3.1 Manual operation of the relays**

The manual operation of the relays can be accomplished in the menu “Relay Status”. If a relay is in the Manual ON or Manual OFF status, the yellow LED at the Controller is on continuously.

The external operation of a relay by an assigned digital input has priority before the manual operation or the Stage set point of a sensor point being exceeded.

Manually operated relays can be reset by selecting the “Automatic” mode.

The reset of Latching relays also is a function in this menu.

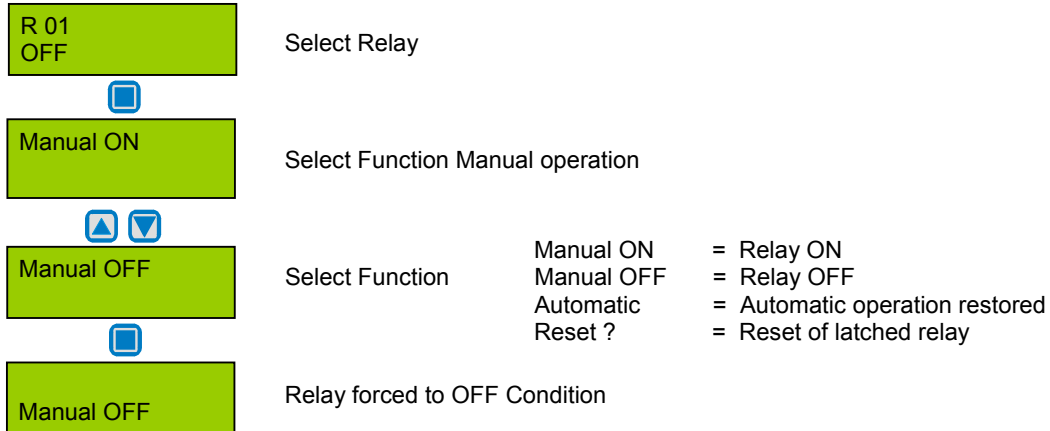

**3.4 Menu Sensor Readings**

In this menu it displays the current value (CV) and average value (AV) with sensor unit and type for each active sensor point (SP) as well as the defined mode of control (CV or AV mode) with “\*” .

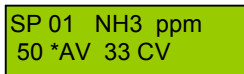

Symbol	Description	Setting Status	Function
SP 01	Sensor Point No.		Select SP No.
NH3	Type	NH3	See 3.6.2
ppm	Unit		See 3.6.2
CV	Current value	CV	Current value of Gas Concentration
AV	Average value		Average value (10 measured values within the time unit)
*	Control mode		Display for the Control mode selected. (CV or AV)
Not active	SP Status	Not active	SP disabled
Error	SP Malfunction		Current signal < 3 mA or > 22 mA

### 3.5 Menu Relay Setup

Display and change the parameters for each relay.

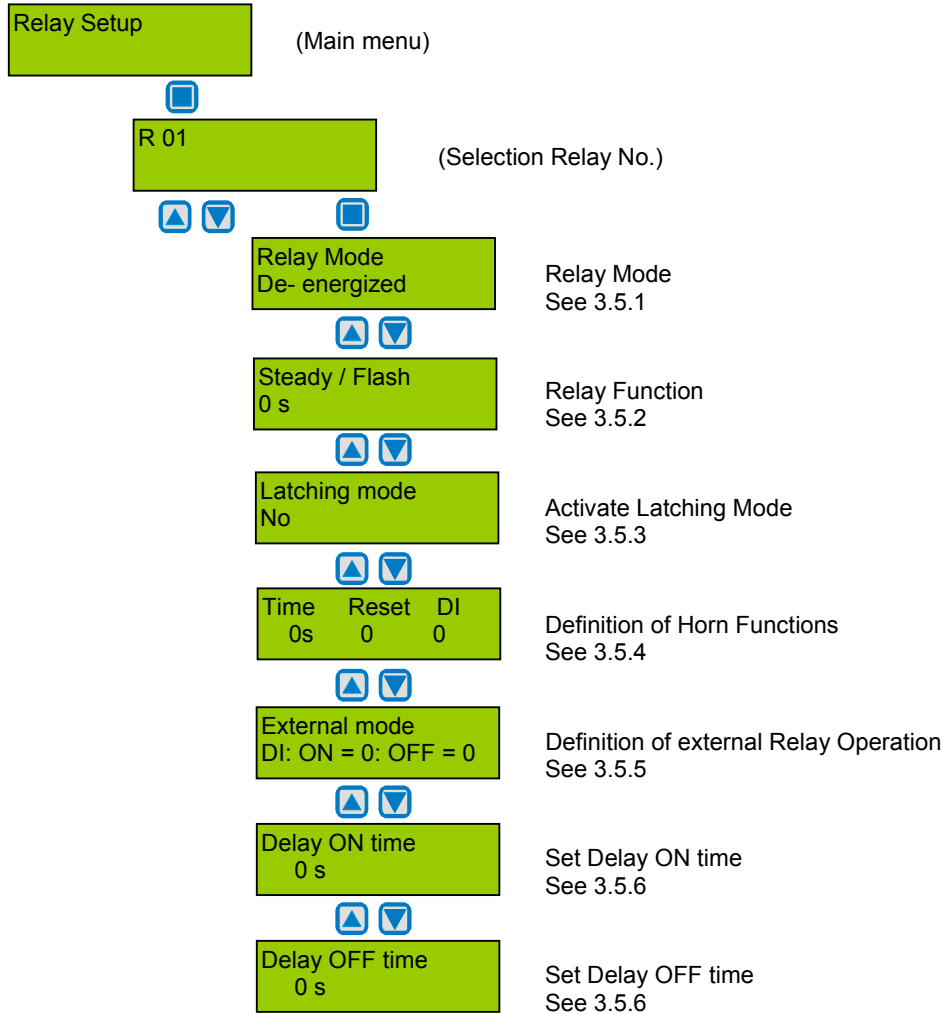

#### 3.5.1 Relay Mode

Symbol	Description	Setting Status	Function
R 01	Relay No.		Selection Relay
De-energized	Relay Mode	De-energized	De-energized = Stage ON = Relay ON Energized = Stage ON = Relay OFF

#### 3.5.2 Relay Action Steady / Flash

Symbol	Description	Setting Status	Function
R 01	Relay No.		Selection Relay
0	Function	0	0 = Relay Function steady > 0 = Relay Function flashing (= Periods time sec.) Impulse / Break = 1:1

**3.5.3 Latching Mode**

Definition of Latching Function

Symbol	Description	Setting Status	Function
R 01	Relay No.		Selection Relay
No	Latching Mode	No	No = Latching Mode non active Yes = Latching Mode active

Acknowledging of a latching relay in the menu “Relay Status” is possible only if the sensor value is smaller than the Staged set point including hysteresis. With this condition then latching is activated.

Example: Relay R2 assigned to Latching mode

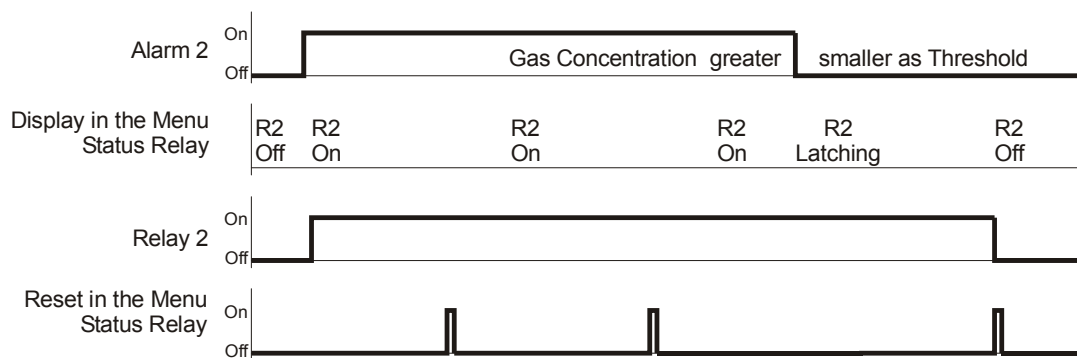

**3.5.4 Horn Function**

With this parameter the relay is defined as a horn relay and can be acknowledged with the following possibilities.

- By pressing one of the arbitrary 6 pushbuttons. (Only possible in the starting menu).
- Automatic acknowledging when the time runs out.
- By an external pushbutton. (Assigned to an appropriate digital input).

The horn function is activated only if at least one of the two parameters (time or digital input) is set.

Special function Response

After acknowledging the relay via Pushbutton or external DI the time starts. If this time runs out and if the stage is still exceeded, the relay is energized again.

Symbol	Description	Setting Status	Function
R 20	Relay No.		Selection Relay
Reset	Mode	0	0 = Acknowledge the relay at time run out, or via Pushbutton 1 = Acknowledge the relay via a Pushbutton, after time runs out and the alarm is still active, then the relay is reactivated.
Time		120	Time in seconds for Automatic acknowledging or before reactivating alarms defined by Reset function
DI		0	Assignment of the digital input used for remote reset of the horn.

Acknowledge the horn relay

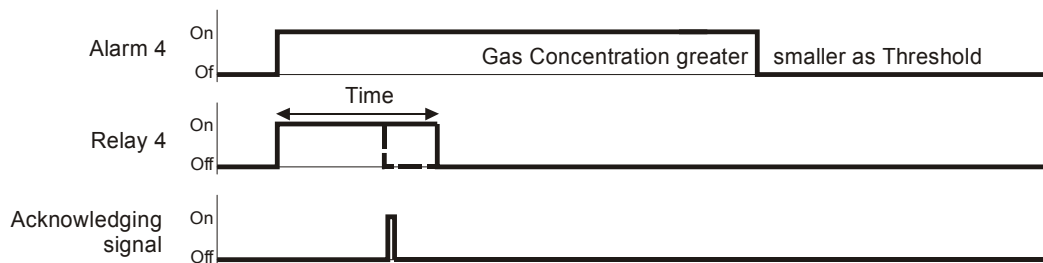

Special function "Response". (Return of the horn relay)

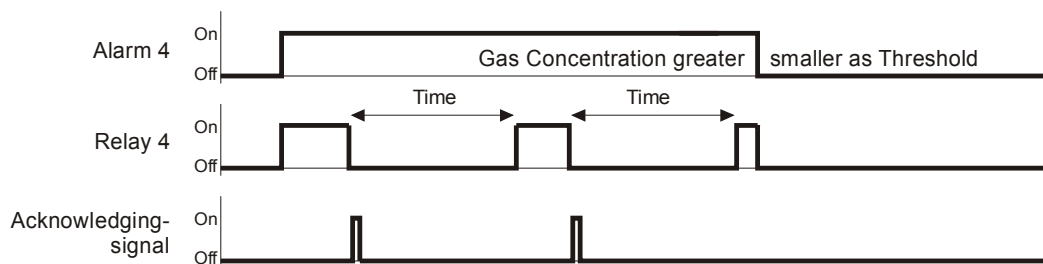

**3.5.5 External operation of Relay.**

Assign one digital input (DI) for external setting of the relay ON and/or OFF. This function has priority before a stage threshold is exceeded and/or manual switching in the menu "Relay Status".

Symbol	Description	Setting Status	Function
R 01	Relay No.	DI	Selection Relay
DI-ON	External On	0	If digital input closed, relay switch ON
DI-OFF	External Off	0	If digital input closed, relay switch OFF

**3.5.6 Delay operation of Relay.**







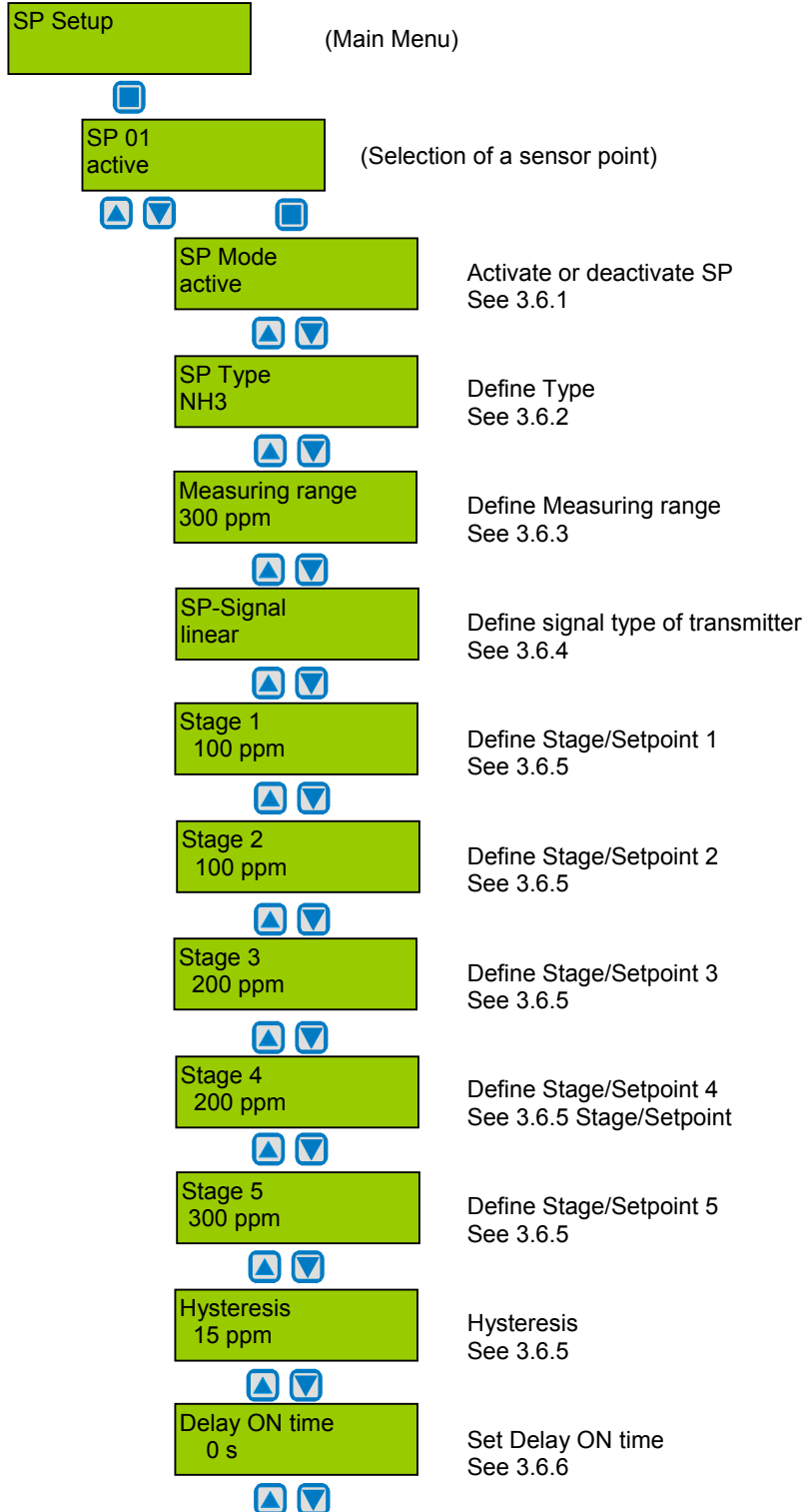

Delay ON time begins when the Stage is exceeded and/or Delay OFF time when the Stage returns to normal condition.

Symbol	Description	Setting Status	Function
R 01	Relay No.		Selection Relay
0 s	Delay Time ON	0	Stage ON: Relay is only activated at expiration of the defined time (sec.) 0 sec. = No Delay
0 s	Delay Time OFF	0	Stage OFF: Relay is only deactivated at expiration of the defined time (sec.) 0 sec. = No Delay

**3.6 Menu SP Setup**

Display and Change Parameters, Assign Stage value, Assign relays to stages and activate each Sensor Point (SP).



Delay OFF time 0 s   	Set Delay OFF time See 3.6.6
AV Mode CV   	Define Control Mode See 3.6.7
Stage - 1 2 3 4 5 Fault - 1 1 0 0 0   	Assign a SP Fault to a Stage See 3.6.8
S1; S2; S3; S4; S5; 01; 02; 03, 04; 05;   	Assign a relay to a Stage See 3.6.9
Analog Output 0	Assign SP signal to a Analog Output See 3.6.10

**3.6.1 Activate – Deactivate SP**

Symbol	Description	Setting Status	Function
SP 01	Sensor point		Selection SP No. (SP01 is the internal Transmitter)
Active	SP Status	not active active	active = Sensor point enabled for reporting not active = Sensor point disabled for reporting

**3.6.2 Selection Type**

Assign sensor Type to active transmitters.

Symbol	Description	Setting Status	Type		Unit	Measuring range <sup>1</sup>
SP 01	Sensor point					
NH3	Type	NH <sub>3</sub>	CO	Carbon monoxide	ppm	0 – 300
			Ex	Combustible gas	%LEL	0 – 100
			NO	Nitrogen oxide	ppm	0 – 50
			NO <sub>2</sub>	Nitrogen dioxide	ppm	0 – 25
			NH <sub>3</sub>	Ammonia	ppm	0 – 300
			O <sub>2</sub>	Oxygen <sup>2</sup>	%V/V	0 – 25
			CO <sub>2</sub>	Carbon dioxide	ppm	0 – 2000
			SO <sub>2</sub>	Sulphur dioxide	ppm	0 – 100
			H <sub>2</sub> S	Hydrogen sulphide	ppm	0 – 200
			CL <sub>2</sub>	Chlorine	ppm	0 – 100
			ETC	Ethylene oxide	ppm	0 – 20
			VOC	Air quality	%	0 – 100
			R401	Refrigerant gas	ppm	0 – 2000
			R402	Refrigerant gas	ppm	0 – 2000
			R408	Refrigerant gas	ppm	0 – 2000
			R409	Refrigerant gas	ppm	0 – 2000
			R404	Refrigerant gas	ppm	0 – 300
			R416	Refrigerant gas	ppm	0 – 300
			R502	Refrigerant gas	ppm	0 – 300
			R410	Refrigerant gas	ppm	0 – 300
R411	Refrigerant gas	ppm	0 – 300			
R11	Refrigerant gas	ppm	0 – 300			
R123	Refrigerant gas	ppm	0 – 300			
R134	Refrigerant gas	ppm	0 – 300			
R22	Refrigerant gas	ppm	0 – 300			
TEM	Temperature	°C	0 – 150			
RH	Humidity	% RH	0 – 100			

<sup>1</sup> Range Recommendations for PolyGard sensors

<sup>2</sup> During oxygen measurement falling signal!

**3.6.3 Measuring range**

The measuring range can be defined from 10 to 10000. The measuring ranges in the above table are typical and only recommendations. For actual ranges see the sensor manufacturing specifications.

The measuring range must agree with the signal (4 to 20 mA) for active transmitters.  
 (4 mA = Display=0, 20 mA = Display Measuring range = max. point)

**3.6.4 SP Signal**

Gas transmitter with electro-chemical or catalytic bead sensors are linear for gas concentration proportional to the 4 to 20 mA signal.

Semiconductor gas sensors that are not linear and have a (exponential) signal. This signal is non-linear 4 to 20 mA signal from the gas transmitter.

The Controller MGC2 has the capability to monitor both types of gas transmitters, and other linear 4-20 mA sensors. The type of signal is defined in this menu.

Symbol	Description	Setting Status	Function
SP 01	Sensor Point		Selection SP No.
Linear	SP Signal	linear	linear = Transmitter with linear Output signal not linear = Transmitter with non linear Output signal (future).



**3.6.5 Stage/Setpoint / Hysteresis**

Each sensor point can have five stages with set point values. If the measured level is greater than the defined stage/set point, the associated stage is set. If the level falls below the stage/setpoint plus the hysteresis then the stage returns to original condition.

It is recommended that the unused stages be set to max of sensor range to avoid the alarm light from false reporting.

For O<sub>2</sub> measurement on depletion consider when defining stage setpoints that stages will be set on a falling measuring signal!

Symbol	Description	Default Status		Function
SP 01	Sensor Point			Selection SP No.
100 ppm	Threshold	100 100 200 200 300 15	Stage/setpoint1 Stage/setpoint2 Stage/setpoint3 Stage/setpoint4 Stage/setpoint5 Hysteresis	Sensor Value > Stage/Set point1 = Stage 1 Sensor Value > Stage/Set point1 = Stage 2 Sensor Value > Stage/Set point1 = Stage 3 Sensor Value > Stage/Set point1 = Stage 4 Sensor Value > Stage/Set point1 = Stage 5 Sensor Value < (Stage/Set pointX –Hysteresis) = Stage X OFF

**3.6.6 Delay time ON or OFF**

Delay ON time begins when the Stage is exceeded and/or Delay OFF time when the Stage returns to normal condition.

Symbol	Description	Default Status	Function
SP 01	Sensor point		Selection SP No.
0 s	Delay Time ON	0	Concentration > Stage Threshold: Relay is only activated at expiration of the defined time (sec.). 0 sec. = No Delay
0 s	Delay Time OFF	0	Concentration < Stage Threshold: Relay is only deactivated at expiration of the defined time (sec.). 0 sec. = No Delay

**3.6.7 Control Mode**

Definition of the alarm evaluation by Current value (CV) or Average value (AV).

Symbol	Description	Default Status t	Function
SP 01	Sensor Point		Selection SP No.
CV	Evaluation	CV	CV = Control the Current value AV = Control the Average value

Current / Average Value Function See: 3.7.4

**3.6.8 Assigned SP Fault to Relay**

Define which stages are activated with a failure of the sensor point.

Symbol	Description	Default Status	Function
SP 01	Sensor Point		Selection SP No.
Stage - 1 2 3 4 5 Fault - 1 1 0 0 0	Failure SP	1 1 0 0 0	0 = Stage not ON at SP Failure 1 = Stage ON at SP Failure

**3.6.9 Assign Relay to a Stage**

Any of the 5 Relays can be assigned freely to any Stage. Stages that do not activate relays receive an assignment of 00.

Symbol	Description	Default Status	Function
SP 01	Sensor Point		Selection SP No.
1	S1	01	01 = Stage 1 activate relay R 01
	S2	02	02 = Stage 2 activate relay R 02
	S3	03	03 = Stage 3 activate relay R 03
	S4	00	00 = Stage 4 does not activate a relay
	S5	05	05 = Stage 5 activate relay R 20 (internal horn)

**3.6.10 Assigned SP Signal to analog Output**

The sensor point signal can be assigned to one of the ten analog Outputs. The signal defined in the control mode (Current Value or Average Value) is transmitted.

Analog output see also: 3.7.2

Symbol	Description	Default Status	Function
SP 01	Sensor Point		Selection SP No.
0	A	0	0 = SP Signal not assigned to any analog output 1 = SP Signal assigned to analog output 1 X = SP Signal assigned to analog output X

### 3.7 Menu System Setup

Display and change the System Parameters for the Controller

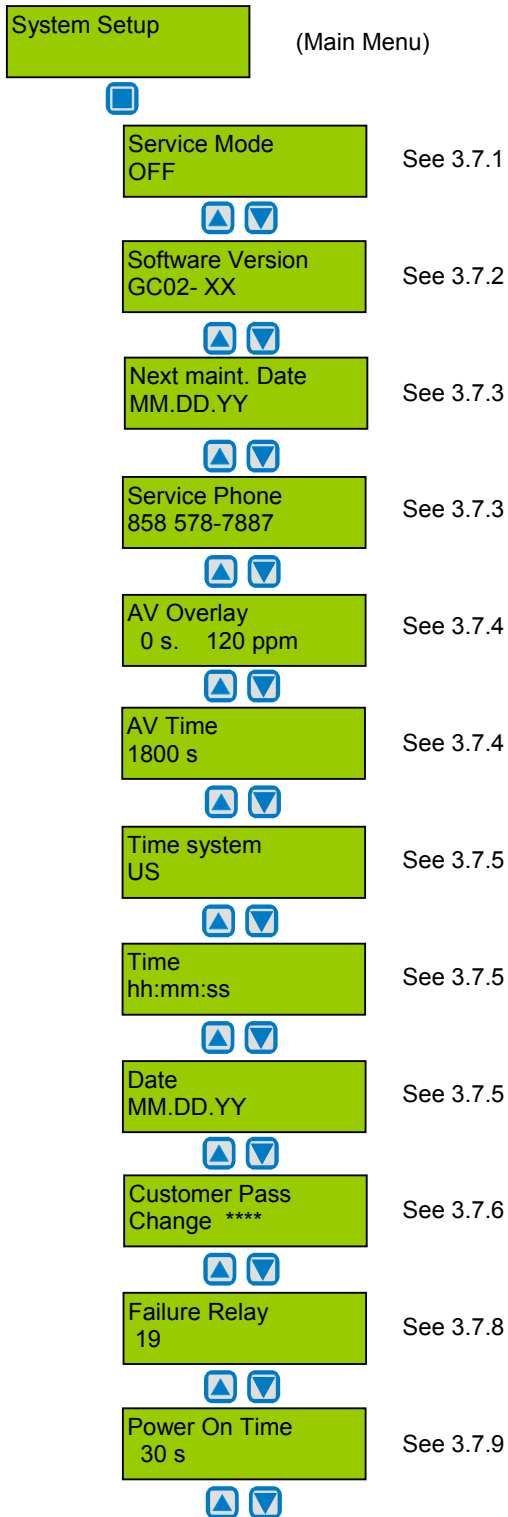

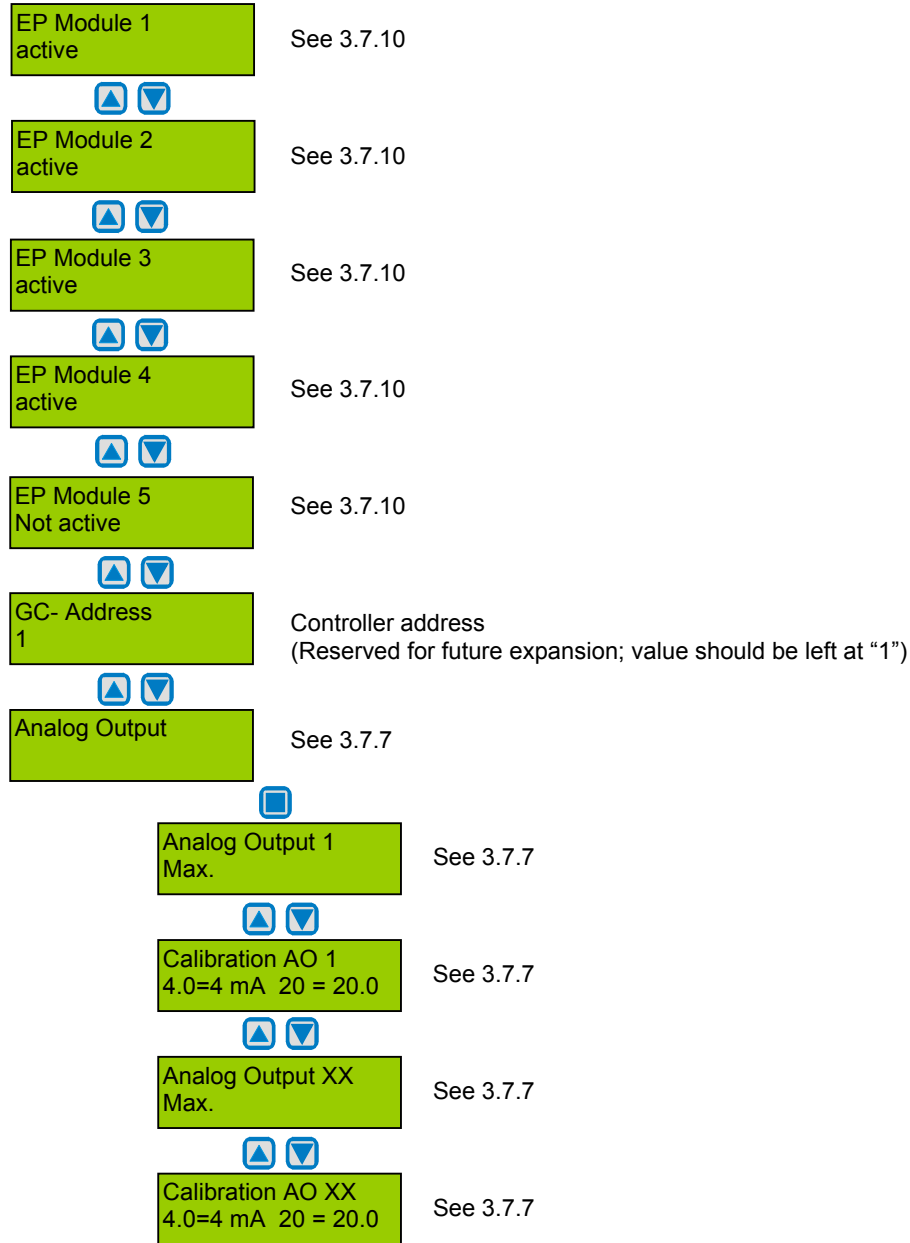

**3.7.1 Service Mode**

If the Service mode is set to (ON) then the stage/setpoints are disabled so relays are not activated during calibration or service work. The service mode is Reset automatically after 60 minutes or when the service mode is set to Off.

Symbol	Description	Default Status	Function
Off	Service Mode	Off	Off = Stages exceeded will activate the assigned relays On = Stages exceeded will not activate the assigned relays

**3.7.2 Software Version**

Symbol	Description	Default Status	Function
GC02-XX	Software Version		XX = Software Version

**3.7.3 Maintenance Concept**

The MGC2 system monitors the maintenance intervals as required, by local Regulations or Customer requirements.

During startup and/or after maintenance the date for next maintenance is entered. When this date is reached at 9 o'clock the next morning a failure signal is activated and Start Menu displays the phone No. of the service company. The failure signal (maintenance) can be acknowledged by the operator. The maintenance message (Service Phone No.) is reset after maintenance is accomplished and a new maintenance date is entered.

The service phone number can be individually entered in the next menu.

Symbol	Description	Default Status	Function
MM.DD.YY	Maintenance		MM.DD.YY = Input date for next maintenance.
8585....	Phone No.		Input the individual service phone No.

**3.7.4 Average Value Function**

The Controller calculates for each active sensing point the arithmetic average value from 10 measurements within the time unit defined in this menu "AV-time". This average value is indicated in the menu "Sensor Readings" near the Current Value. During each Sensor Point Setup the control mode of Current Value or Average Value for the Stage/Setpoint evaluation is defined.

The evaluation of the control mode Average Value is overlaid by the Current Value, if this exceeds Stage/Setpoint defined in the menu "AV-Overlay". The overlay is delayed by the time factor set in this menu.

Symbol	Description	Default Status	Function
120 s 120ppm	AV- Overlay	120 s 120 ppm	sec. = Delay time average value Overlay. 0 = No overlay Function ppm = Threshold average Overlay
1800 s	AV-Time	1800 s	sec. = Time to calculate average value

**3.7.5 Time, Date**

Input and correction of the system time and date. Selection of the time and date format.

Symbol	Description	Default Status	Function
US	Time format	US	EU = Display time and date in EU format US = Display time and date in US format
hh.mm.ss	Time		hh.mm.ss = Input the correct time (EU format) hh.mm.ss am = Input the correct time (US format)
MM.DD.YY	Date		TT.MM.JJ = Input the correct date (EU format) MM.DD.YY = Input the correct date (US format)

**3.7.6 Customer Password (Code 1)**

Change the System Password for level 1

Symbol	Description	Default Status	Function
1234	Customer-password	1234	1234 = Define the Customer Password with 4 characters

Factory preprogrammed system password "9001".

**3.7.7 Analog Output**

The Controller has two analog outputs (AO) with 4 to 20 mA signal per control module. Each of the ten analog outputs can be assigned the signal of one or more sensor points. The assignment occurs in the menu "SP Setup" for each SP. The sensor point sends the signal that is defined in the menu "C/A Mode".

The Controller determines from the signal of all assigned sensor points the minimum, the maximum or the average value and sends this value to the analog output. The determination of which value is sent is defined in this menu "Analog Output X". The analog output can be calibrated for 4 and 20 mA using an ampere meter attached (with measuring range 25 mA) then respective AO factor can be changed to adjust the analog output 4 and/or 20 mA. During AO calibration no evaluation is made of the sensor point signals. This calibration is factory-set. The factors should only be changed if you have an accurate amp meter.

Symbol	Description	Default Status	Function
Max.	Select Output mode	Max.	Min. = Spends the minimum value of all assigned SP Max. = Spends the maximum value of all assigned SP Average = Spends the average value of all assigned SP
4.0 20.0	Calibration	4.0 20.0	4.0 = Calibration factor at 4 mA 20.0 = Calibration factor at 20 mA

**3.7.8 Define the Failure Relay**

Define the Failure Relay. See also malfunction management (3.1)

Symbol	Description	Default Status	Function
19	Failure Relay	R19	R19 = Define the failure relay

**3.7.9 Power On Time**

Sensors need a warm up period until the chemical process of the sensor reaches a stable condition. During this warm up period the current signal can cause unwanted false alarms. Therefore, the Controller starts reporting alarms after the Power ON Time delay once power is applied. While this time runs off, the Controller does not report alarms. The Power On status is displayed.

Symbol	Description	Default Status	Function
30 s	Power On Time	30 s	XX = Define the Power On Time (sec.)

**3.7.10 Activation of expansions modules**

The Gas Controller can manage, up to five expansions modules (EP-02). Each EP-02 has four analog inputs and five alarm relays and two analog outputs. Each attached EP-02 is announced in this menu. The Controller checks the communication to the registered EP-02 modules and shows a fault signal in case of a communication error. To recognize the position of the EP-02 modules a module address is assigned to each module by the address selector. See table.

The table shows the assignment of the MP and relay numbers to the individual modules.

Symbol	Description	Default Status	Function	Module Addr.	Relay No.	SP No.	Output No.
Not active	EP- Module No 1	active	Active = EP announced.	1	06 to 10	05 to 08	03 to 04
	EP- Module No 2	active		2	11 to 15	09 to 12	05 to 06
	EP- Module No 3	active		3	16 to 20	13 to 16	07 to 08
	EP- Module No 4	active	Not active = EP not announced	4	----	17 to 20	09 to 10
	EP- Module No 5	Not active		5	----	-----	-----

## 4 Mounting / Electrical Connection

The Controller is installed through the 4 marked mounting holes at the back of the housing. These mounting holes are accessible after opening the housing. See Fig. 01

The mounting holes should be covered with the enclosed caps after installation.

Please consider the following when selecting the mounting place:

- Avoid locations where water, oil etc. may influence proper operation and where mechanical damage might be possible.
- Install cables only from the Topside.
- On the left side keep at least 150 mm distance to open the transparent door.
- Consider any unusual condition or requirements of the Customer.

Fig. 01

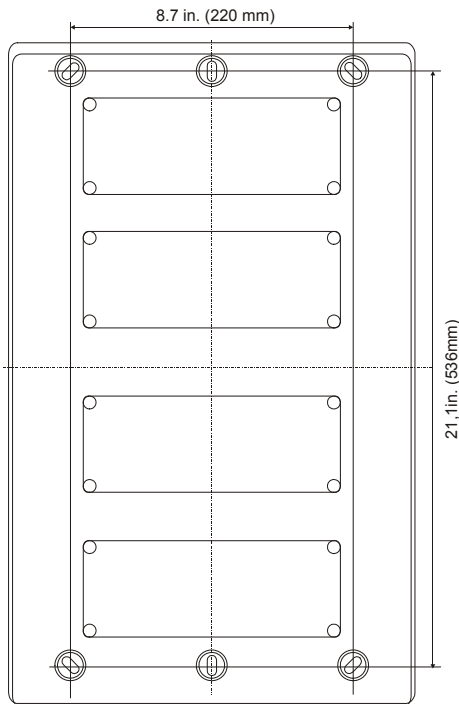

### 4.1 Electrical Connection

Installation must be done per local electrical codes with the consideration of the technical requirements of the product.

The alarms are available as SPDT, potential free contacts.

For the exact position of the terminations of the relays see the following connection diagram.



**4.2 Unit position – Connection diagram**

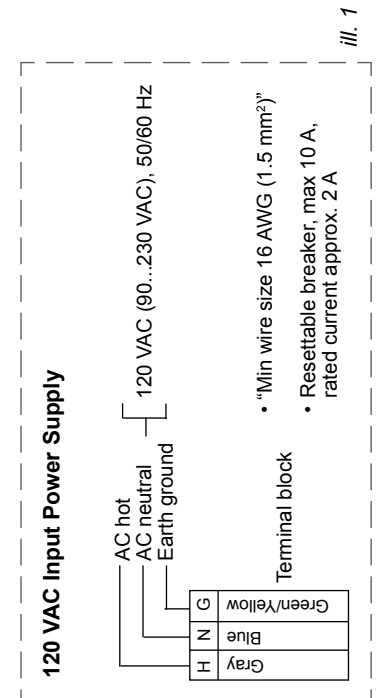
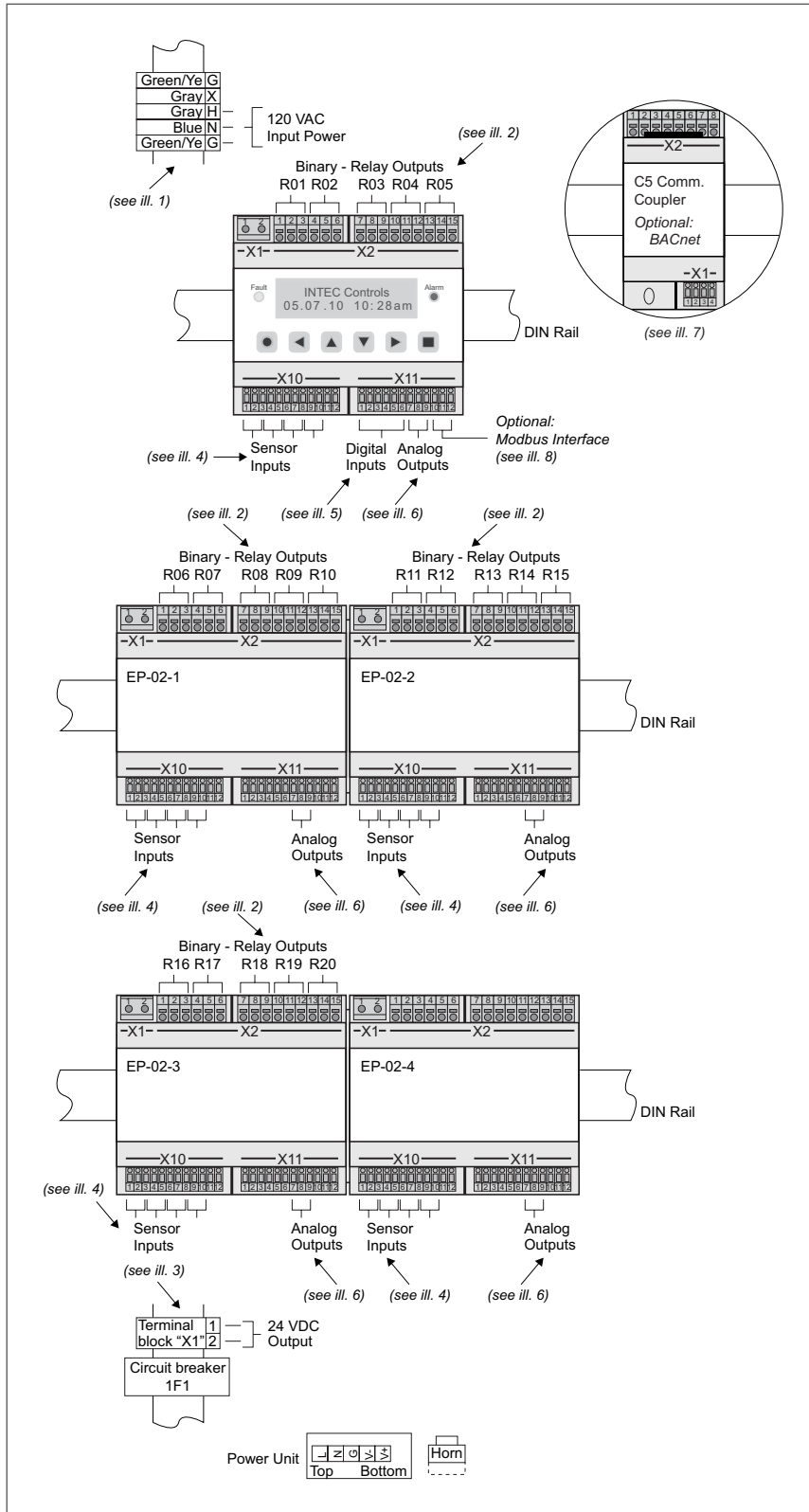

ill. 1

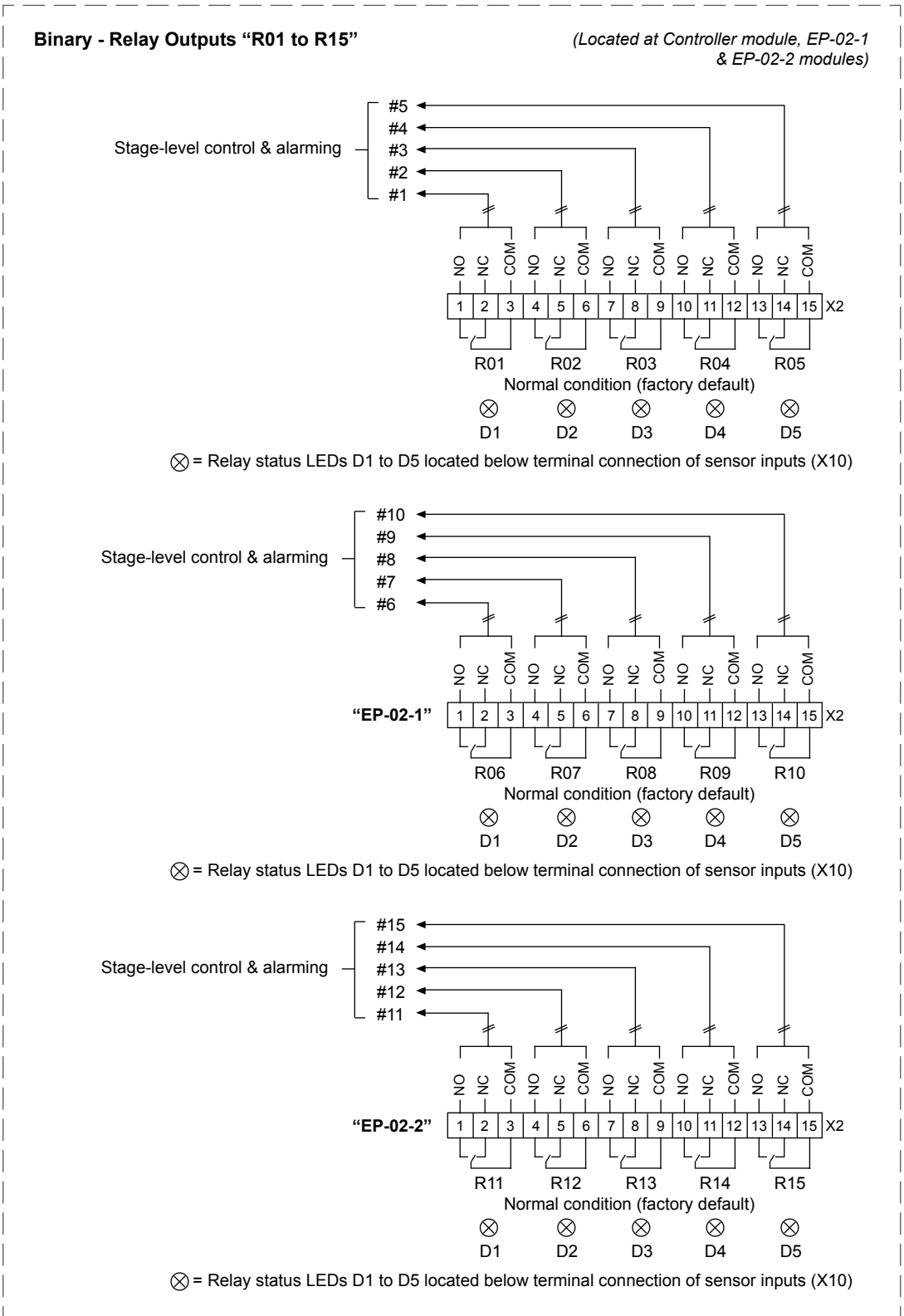

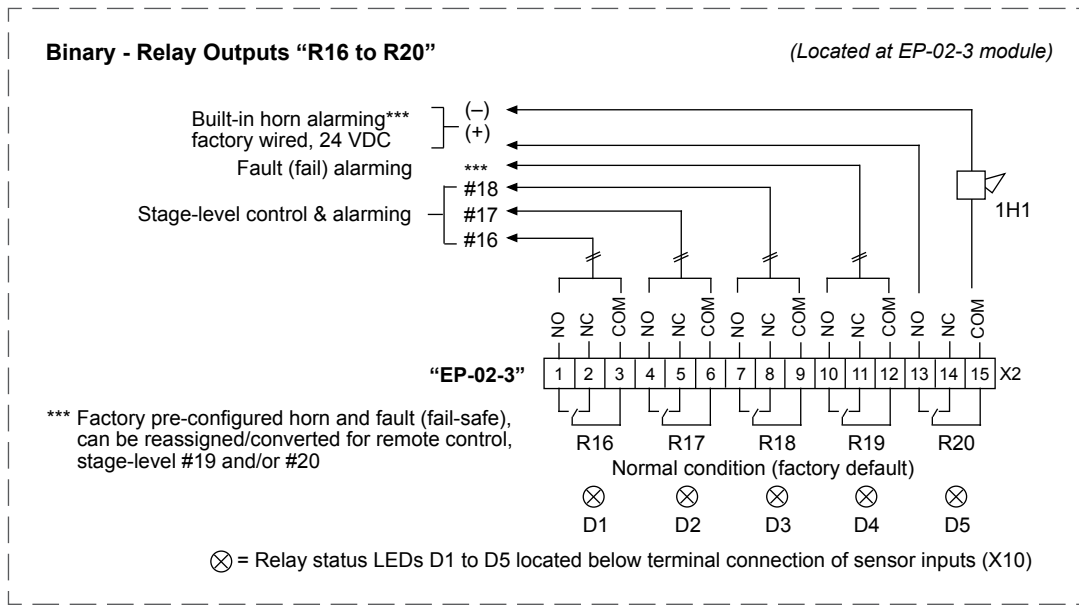

ill. 2 (cont...)

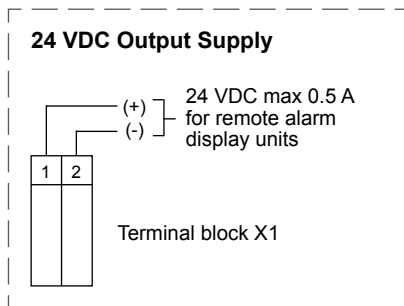

ill. 3

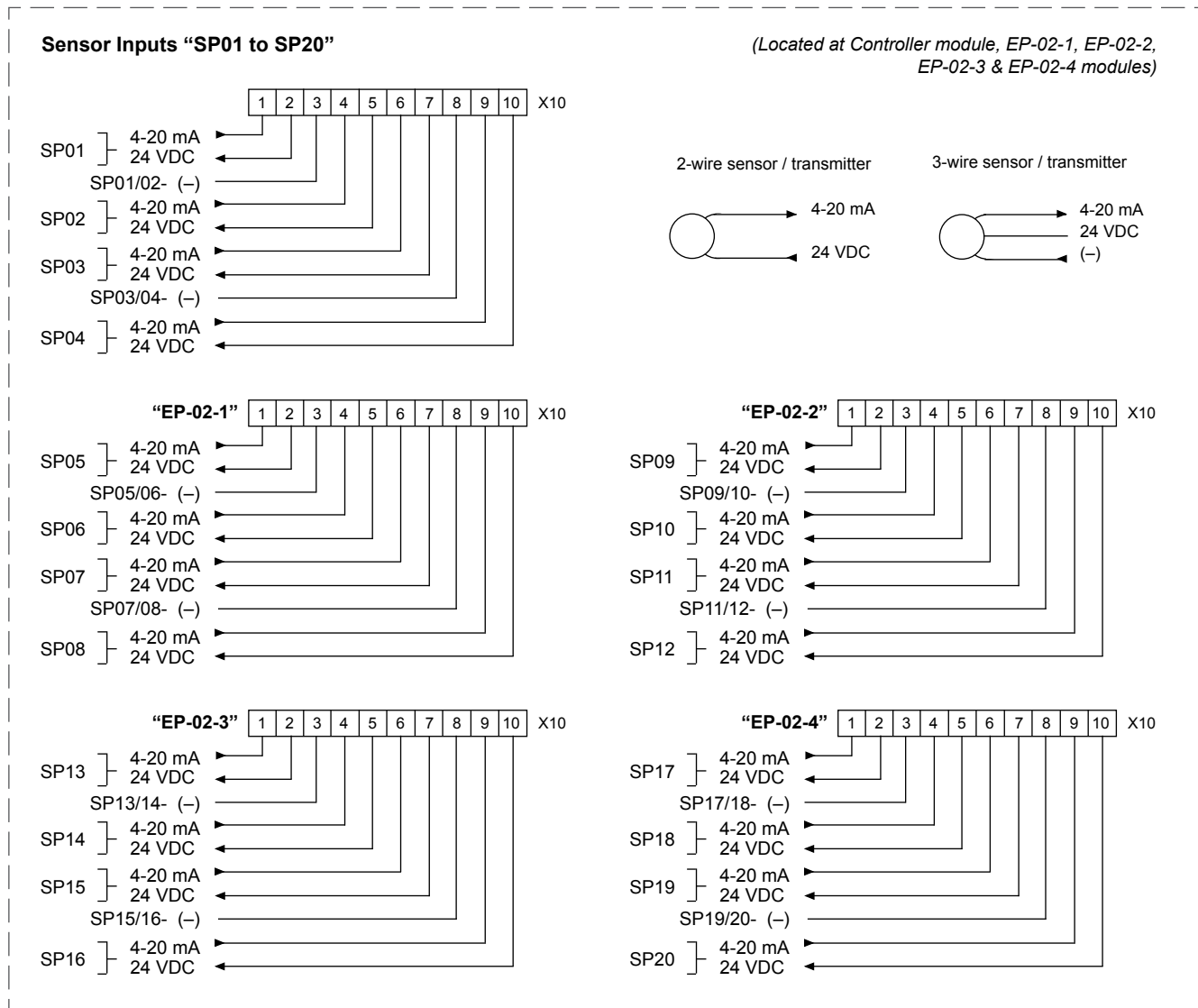

ill. 4

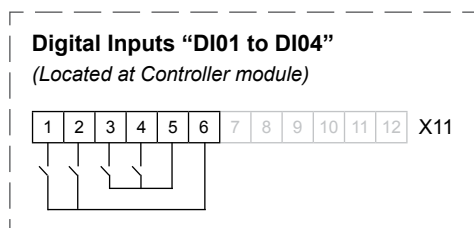

## **5 Start-up Operation**

### **5.1 Start-up**

Before beginning start-up the wiring of the Controller including all field devices must be completely terminated!

After switching the power supply "ON" and the end of the Power On Time, then the Controller is ready for use.

The electrochemical sensor needs a warm up time of 1 hour to reach its highest accuracy.

The Controller is delivered with standard parameters and stages/set points. The assignment of the relays to the individual stages can occur at start-up unless arrangements have been made with the factory for programming. All other parameters are to be examined and adapted to the local conditions.

**5.2 Checklist Start-up operation**

**System Setup**

Parameters	Finish
Registration of existing EP-02 modules	
Time and Date	
Parameter Average Function	
Password level 1 (Customer Password)	
Function analog output	
Define failure relay	
Power On Time	
Service Phone No.	
Maintenance date	

**Relay Setup**

Parameters	Finish																				
	Relay R	1	2	3	4	5	6	7	8	9	10	11	12	13	14	15	16	17	18	19	20
Relay Mode																					
Function Steady / Flash																					
Latching Mode																					
Horn function																					
External Relay operation																					
Delay ON time																					
Delay OFF time																					

**SP Setup**

Parameters	Finish																				
	SP No.	1	2	3	4	5	6	7	8	9	10	11	12	13	14	15	16	17	18	19	20
SP Mode																					
Type																					
Measuring range																					
SP- Signal																					
Stage/Setpoint 1																					
Stage/Setpoint 2																					
Stage/Setpoint 3																					
Stage/Setpoint 4																					
Stage/Setpoint 5																					
Hysteresis																					
Delay ON time																					
Delay OFF time																					
C/A Mode																					
Assigned Failure <> Stage																					
Assigned Stage<> Relay																					
Assig. SP <> Anal. Output																					

## 6 Configuration- and Parameter card

Commission:		Project No.	
Customer:			
Start-up - company			
Start-up - date:		Service Technician	

### 6.1 Configurations System Setup

Service	Software Version	Maintenance date	Service Phone	AV- Overlay			Time system	Customers pass	Power On Time	Failure Relay
				ppm	Time	AV-Time				
Default	15	06.06.06	858 578-7887	120	120	1800	US	1234	30 s	19

Analog output 1			Analog output 2			Analog output 3			Analog output 4		
	Calibration			Calibration			Calibration			Calibration	
Mode	= 4	= 20	Mode	= 4	= 20	Mode	= 4	= 20	Mode	= 4	= 20
Max.	4.0	20.0	Max.	4.0	20.0	Max.	4.0	20.0	Max.	4.0	20.0

Analog output 5			Analog output 6			Analog output 7			Analog output 8		
	Calibration			Calibration			Calibration			Calibration	
Mode	= 4	= 20	Mode	= 4	= 20	Mode	= 4	= 20	Mode	= 4	= 20
Max.	4.0	20.0	Max.	4.0	20.0	Max.	4.0	20.0	Max.	4.0	20.0

Analog output 9			Analog output 10		
	Calibration			Calibration	
Mode	= 4	= 20	Mode	= 4	= 20
Max.	4.0	20.0	Max.	4.0	20.0

**6.2 Relay Setup**

Relay No.	Mode	Steady Flash	Latching mode	Horn Function			External		Delay time	
				Ti	Reset	DI	ON	OFF	ON	OFF
Default	Energize	0 s	No	0	0		DI	DI	Time	Time
R01										
R02										
R03										
R04										
R05										
R06										
R07										
R08										
R09										
R10										
R11										
R12										
R13										
R14										
R15										
R16										
R17										
R18										
R19										
R20										



# PolyGard® Multi-Point Controller User Manual - MGC2-20



## 6.3 Sensor Setup

SP No.	SP Status	Type	Measuring range	SP-Signal	Stage/Setpoints					Hyst	Delay time (sec.)		CV/AV	Assigned SP fault <>Stage AO					Assigned Stage/Setpoint<> Relay					AO		
					S1	S2	S3	S4	S1		ON	OFF		S1	S2	S3	S4	S5	R1	R2	R3	S4	S5			
Default	Not active	CO	250	Linear	25	50	100	250	100	15	0	0	CV	1	1	0	1	0	0	R1	R2	R3	0	0		
01																										
02																										
03																										
04																										
05																										
06																										
07																										
08																										
09																										
10																										
11																										
12																										
13																										
14																										
15																										
16																										
17																										
18																										
19																										
20																										

Polygard® is a registered trademark of MSR

MGC2-20

Customer Services (858) 578-7887 & (888) GO INTEC Fax (858) 578-4633 & (888) FX INTEC  
 INTEC Controls, 12700 Stowe Dr., Suite 110, Poway, CA 92064 www.inteccontrols.com

Specification subject to change without notice.  
 Printed in USA 131119

## 7 Specifications MGC2-20

<b>Electrical</b>	
Power supply	120 VAC (90 to 230 VAC) 50/60Hz resettable breaker
Power Consumption	60 VA, max.
RF/RMI protected	4.0 W @ 3 ft. (1 m) radiated
<b>Type of control</b>	
General	Five-stage (S1 to S5) control, assignable up to twenty (20) binary/relay output, i.e. Low-med-high-fault / fail-horn*, or low1-low 2-med1-med2-high, or any other combinations (* = horn/audible alarm built-in and factory pre-configured to relay output "R20")
Analog Input	Twenty (20), 4 - 20 mA
Analog reading	Current and mean (average) value
Power supply for Analog inputs	24 VDC max. 50 mA / channel
Stage level / setpoint	Field adjustable over full range, five (5) per analog input, assignable to current or mean (average) value
- hysteresis/ switching differential	Selectable for each sensor point
Digital inputs	Four (4) each can be individually assigned to any relay (R1..R20). Digital inputs are used for remote audio/visual alarm reset
Relay outputs (R1-R20) w/ status LEDs	Twenty (20) SPDT, 8 A, 24 VAC/VDC -250 VAC contact resistance 100 mΩ, max.
- each stage level (S1-S5)	Assignable to any relay
- sensor fail-safe	Assignable to any stage level
Time delay switching	Selectable for make and brake of each sensor point (SP1 to SP20) 0-9,999 seconds
VDC output supply	24 VDC, 0.5 A fused
Analog output	Ten (10) independent 4 - 20 mA signal, 500 Ω max. load, selectable as low, high or averaging of sensor inputs
Audible alarm	90 db, enabled or disabled, selectable; assignable to stage level S1, S2, S3, S4 or S5
Alarm acknowledgement	Menu-driven and system reset function for latched relays
<b>User Interface</b>	
Keypad type	See 2.1 "Description Keypad User Interface"
Touch buttons	Six (6)
Status LED's	Yellow: Alarm; Red: Fault (fail)
Digital display	Liquid Crystal Display (LCD), two lines, 16 characters per line, 1 digit resolution, backlit
- unit display	Menu selectable, per sensor; ppm, %v/v, %LEL; °F or % RH
<b>Environmental</b>	
Permissible ambient	
- working temperature	23 °F to 104 °F (-5 °C to + 40 °C)
- storage temperature	-4 °F to 104 °F (-20 °C to + 40 °C)
- humidity	15 to 95 % RH non condensing
- working pressure	Atmospheric ± 10%

<b>Physical</b>	
Enclosure (panel)	Plastic housing with view cover
- material	Polycarbonate, impact resistance EN 50102/K08, flammability rating UL 94-5V
- conformity	UL Type 1, UL508/UL 50 standards
- color	Light gray, smoked gray for cover
- protection	NEMA 4X (IP65)
- installation	Wall (surface) mounted
Dimensions (H x W x D)	
- base	22.8 x 12.0 x 5.7 in. (580 x 306 x 145 mm)
- Cable entry	10 holes for ½ in. conduit, covered
Wire connection	Terminal blocks, Push-on connect and screw type for lead wire
Wire size	
- input	Min. 22 AWG (0.34 mm <sup>2</sup> ) Max. 16 AWG (1.5 mm <sup>2</sup> )
- output	Min. 24 AWG (0.25 mm <sup>2</sup> ) Max. 14 AWG (2.5 mm <sup>2</sup> )
Weight	14.5 lbs. (6.6 kg)
<b>Approvals / Listings</b>	
- unit	City of Los Angeles Approved (pending) VDI 2053, C-No. 418791, CE EMV-Compliance 89/336/EWG
- power supply unit	UL Recognized, E183223 CSA Certified, E183223
- relays (R1 – R20)	UL Recognized, E5610 & E108658 CSA, C22.2 No. 14, LR35579 VDE
- enclosure (panel)	UL Listed, E75645

## **8 Notes and General Information**

It is important to read this user manual thoroughly and clearly understand the information and instructions. The PolyGard® MGC2 monitoring, control and alarm system must be used within product specification capabilities. The appropriate operating and maintenance instructions and recommendations must be followed.

Due to ongoing product development, MSR reserves the right to change specifications without notice. The information contained herein is based upon data considered to be accurate. However, no guarantee is expressed or implied regarding the accuracy of this data.

### **8.1 Intended product application**

The PolyGard® MGC2 are designed and manufactured for control applications for energy savings and OSHA air quality compliance in commercial buildings and manufacturing plants (i.e., detection and automatic exhaust fan control for automotive maintenance facilities, enclosed parking garages, engine repair shops, warehouses with forklifts, fire stations, tunnels, etc.).

### **8.2 Installers' responsibilities**

It is the installer's responsibility to ensure that all PolyGard® MGC2 are installed in compliance with all national and local codes and OSHA requirements. Installation should be implemented only by individuals familiar with proper installation techniques and with codes, standards and proper safety procedures for control installations and the latest edition of the National Electrical Code (ANSI/NFPA70). It is also essential to strictly follow all instructions as provided in the user manual.

### **8.3 Maintenance**

It is recommended that the PolyGard® MGC2 performance check is done on a routine schedule. Any performance deviations may be serviced based on needed requirements. Part replacement may be implemented in the field by a qualified individual and with the appropriate tools.

### **8.4 Limited warranty**

MSR-Electronic-GmbH and INTEC Controls warrants the PolyGard® MGC2 for a period of two years from the date of shipment against defects in material or workmanship. Should any evidence of defects in material or workmanship occur during the warranty period, INTEC Controls will repair or replace the product at their own discretion, without charge.

This warranty does not apply to units that have been altered, had attempted repair, or been subject to abuse, accidental or otherwise. The above warranty is in lieu of all other express warranties, obligations or liabilities.

This warranty applies only to the PolyGard® MGC2. MSR-Electronic-GmbH and/or INTEC Controls shall not be liable for any incidental or consequential damages arising out of or related to the use of the PolyGard® MGC2.

If the PolyGard® MGC2 needs to be returned to INTEC Controls for service, an RMA number must be obtained prior to sending.