

TIGER^{LT}



Instrument User Manual V1.5



Authorized Distributor:
GasDetectorsUSA.com
Houston, Texas USA
sales@GasDetectorsUSA.com
832-615-3588

Register
your instrument
online to receive
your extended
warranty.

Unrivalled Detection.

ionscience.com

Register your instrument online for extended warranty

Thank you for purchasing your Ion Science product.

The standard warranty of your instrument is one year however the warranty can be extended.

To extend the warranty to 2 years, you must register your instrument online within one month of purchase (terms and conditions apply.)

Visit www.ionscience.com/instrument-registration



Warnings

USER MANUAL:	Read and understand this user manual completely before operating the PhoCheck Tiger® instrument.
STATIC HAZARDS:	Do not use abrasive or chemical detergents to clean the PhoCheck Tiger instrument as this may reduce the antistatic properties of the materials used, clean it using a damp cloth only.
MATERIAL EXPOSURE	The PhoCheck Tiger must not be exposed to atmospheres known to have an adverse effect on Thermoplastic polyolefin or Anti-static PC/ABS
SERVICING:	Do not remove the sensor cover in the hazardous area. No part of the PhoCheck Tiger may be opened in a hazardous area except for replacement of the battery pack. The PhoCheck Tiger must be serviced in a Non Hazardous environment and by Ion Science authorised service centres only. Do not service the instrument live; Remove battery pack before servicing Substitution of components may impair intrinsic safety.
BATTERY CHARGING:	Charge PhoCheck Tiger and its Lithium ion battery packs in a Non Hazardous environment only.
BATTERY REPLACEMENT:	Never replace primary Alkaline battery cells while in a potentially explosive or hazardous location. Use only Duracell Procell® Alkaline alkaline batteries MN1500.
BATTERY CONNECTION:	The PhoCheck Tigers lithium ion and alkaline battery packs have been specially designed to allow connection to the PhoCheck Tiger Instrument while in potentially hazardous atmospheres. Ensure all electrical connections are clean and undamaged before connection: The PhoCheck Tiger instruments ingress protection rating is reduced to IP20 when its battery pack is removed so avoid changing batteries in dusty or wet environments.
BATTERY USE:	Use supplied battery packs only on the PhoCheck Tiger. Never replace primary Alkaline alkaline battery cells while in a potentially explosive or hazardous location. Use only Duracell Procell® Alkaline alkaline batteries MN1500.
FUNCTIONAL TEST:	The PhoCheck Tiger must be functionally checked prior to entering a hazardous area after every occasion when a connection has been made to the USB port. The instrument must complete its start-up routine and display legible readings. If the LCD display fails to show an intelligible and uncorrupted display the instrument must not enter a hazardous area.
USB CONNECTION:	The USB port can only be used in a Non Hazardous environment.

Proper Use	If the equipment is used in a manner not specified by the manufacturer, the protection provided by the equipment may be impaired.
Type of safety protection	Intrinsically safe
USB CONNECTION	The USB port can only be used in a Non Hazardous environment.



Avertissement

MODE D'EMPLOI :	Veillez lire entièrement et comprendre ce mode d'emploi avant d'utiliser l'instrument PhoCheck Tiger.
RISQUES LIES AUX PROPRIETES ANTISTATIQUES :	N'utilisez pas de détergents abrasifs ou chimiques pour nettoyer l'instrument PhoCheck Tiger, au risque de réduire les propriétés antistatiques des matériaux utilisés. Employez uniquement un chiffon humide.
EXPOSITION AUX MATERIAUX :	N'exposez pas le PhoCheck Tiger à des atmosphères connues pour avoir un effet indésirable sur la polyoléfine thermoplastique ou le PC/l'ABS antistatique.
ENTRETIEN :	Ne retirez pas le couvercle du capteur dans les zones dangereuses. N'ouvrez aucune partie du PhoCheck Tiger dans une zone dangereuse, sauf pour le remplacement de la batterie. L'entretien du PhoCheck Tiger doit se dérouler dans un environnement non dangereux et être confié uniquement à des centres de service agréés Ion Science. Ne procédez pas à l'entretien de l'instrument lorsqu'il est sous tension. Otez la batterie avant l'entretien. Le remplacement de composants risque de nuire à la sécurité intrinsèque.
CHARGE DE LA BATTERIE :	Chargez le PhoCheck Tiger et sa batterie lithium-ion uniquement dans un environnement non dangereux.
REPLACEMENT DES PILES:	Ne remplacez jamais de piles alcalines dans un endroit dangereux ou potentiellement explosif. N'utilisez que des piles alcalines Duracell Procell MN1500.
CONNEXION DES PILES/DE LA BATTERIE :	Les batteries lithium-ion et les piles alcalines du PhoCheck Tiger ont été spécialement conçues pour permettre la connexion à l'instrument PhoCheck Tiger dans des atmosphères potentiellement dangereuses. Assurez-vous que les connexions électriques sont propres et intactes avant la connexion. L'indice de protection des instruments PhoCheck Tiger étant ramené à IP 20 lors du retrait de la batterie, évitez de remplacer les batteries dans des environnements poussiéreux ou humides.
UTILISATION DES PILES/DE LA BATTERIE :	N'utilisez que les batteries fournies avec le PhoCheck Tiger. Ne remplacez jamais des piles alcalines primaires dans un endroit dangereux ou potentiellement explosif. N'utilisez que des piles alcalines Duracell Procell MN1500.
ESSAI DE FONCTIONNEMENT :	Le PhoCheck Tiger doit subir un essai de fonctionnement avant de pénétrer dans une zone dangereuse chaque fois qu'une connexion a été effectuée au port USB. L'instrument doit terminer sa routine de démarrage et afficher des valeurs lisibles. Si l'écran LCD n'affiche pas de données correctes et intelligibles, n'utilisez pas l'instrument dans une zone dangereuse.
CONNEXION USB :	Le port USB peut uniquement être utilisé dans un environnement non dangereux.

Utilisation appropriée	Si l'équipement est utilisé d'une manière non spécifiée par le fabricant, la protection fournie par l'équipement peut être altérée.
Type de protection de sûreté :	Sécurité intrinsèque
CONNEXION USB :	Le port USB peut uniquement être utilisé dans un environnement non dangereux



Declaration of conformity

Manufacturer: Ion Science Ltd, The Way, Fowlmere, Cambridge, UK. SG8 7UJ

Product: TIGER

Product description: Intrinsically safe photo-ionisation gas detector for detecting volatile organic compounds

Directive 2014/34/EU **Required Coding -**  II 1 G Ex ia IIC T4 Ga

T_{amb.} = -15°C to +45 °C (with Lithium ion Battery pack)

T_{amb.} = -15 °C to +40 °C (with Alkaline Battery pack)

Certificate Number- ITS09ATEX26890X issue 2
IECEX ITS 10.0036X issue 4

Notified body: Intertek, 0359, Chester, UK

Report number: 102394781CHE-001

Intertek 3193491 Conforms to UL Std. 913, 61010-1 & Certified to CAN/CSA Std. C22.2 No.61010-1

Standards

BS EN 60079-0: 2012 Electrical apparatus for explosive gas atmospheres. General requirements

BS EN 60079-11: 2012 Explosive atmospheres. Equipment protection by intrinsic safety "i"

BS EN61326-1:2006 Electrical equipment for measurement, control and laboratory use - EMC requirements. Group 1, Class B equipment - (emissions section only)

BS EN61326-1:2006 Electrical equipment for measurement, control and laboratory use - EMC requirements. Industrial location immunity - (immunity section only)

BS EN50270:2006 Electromagnetic compatibility - Electrical apparatus for the detection and measurement of combustible gases, toxic gases or oxygen. Immunity Type 2 - industrial environments.

CFR 47:2008 Class A Code of Federal Regulations: 15 Subpart B- Radio Frequency Devices - Unintentional Radiators

Other Standards

BS EN ISO 9001: 2008 Quality Management System - Requirements

BS EN 80079-34: 2011 Application of Quality Systems for equipment manufacture

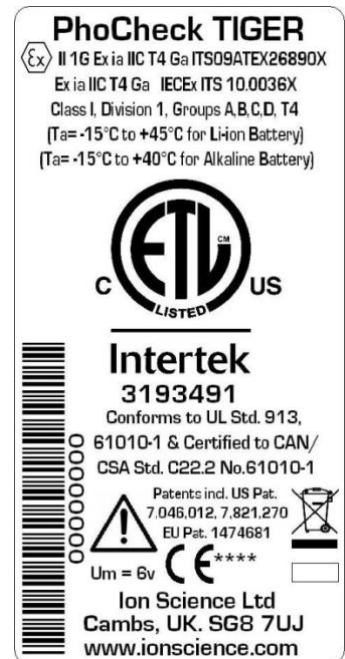

On behalf of Ion Science Ltd, I declare that, on the date this product accompanied by this declaration is placed on the market, the product conforms to all technical and regulatory requirements of the above listed directives.

Name: Mark Stockdale

Position: Technical Director

Signature:

Date: 28th April 2016



Contents

Warnings	3
Avertissement	4
Declaration of conformity	5
Statements	7
Responsibility for Use	7
IMPORTANT	7
Quality Assurance	7
Disposal	7
Calibration Facility	7
Legal Notice	7
Introduction to Tiger^{LT}	8
Getting started	9
The Manual	9
Inlet Probe	9
Turn On	9
Turn Off	9
Batteries	9
Response Factor	9
Set Alarm Levels	9
TIGER PC ^{LT}	9
Understanding the keypad	10
General Description	10
Keypad Function Descriptions	10
Understanding the display screen	11
Screen Display	11
Status icon	11
Main Screen Area	12
Soft key areas	13
Using your Tiger^{LT}	14
Tiger PC^{LT} software installation	17
Connecting TIGER ^{LT} to a PC	17
Summary Screen	20
The Configuration Screen	21
Calibration	23
The Firmware Screen	24
Downloading Data Logged Readings	26
Software Disclaimers	28
Batteries	29
Recharging Batteries	29
Replacement / Exchange of Battery Packs	30
Replacement of Non-rechargeable Batteries in Battery Pack	31
Diagnostics	32
Maintenance	33
Calibration	33
Inlet Probe (Part number: 880207) from January 2016	34
PTFE Filter Disc (861221)	34
PID Sensor/Lamp Replacement and Cleaning	35
Lamp Cleaning	36
Tiger^{LT} parts	37
Tiger main assembly	37
Accessories	38
Instrument warranty and service	39
Warranty	39
Service	39
Contact Details:	39
Technical specification	40
Manual log	41



Statements

Responsibility for Use

TIGER^{LT} instruments detect a large range of gases which are potentially dangerous from both a poisoning and/or an explosive perspective. TIGER^{LT} instruments have many adjustable and selectable features allowing the detector to be used in a variety of ways. Ion Science Ltd can accept no responsibility for the incorrect adjustment of features that cause harm or damage to persons or property. TIGER^{LT} can be used as a personal safety device. It is the user's responsibility to respond appropriately to an alarm situation.

Inadequate performance of the gas detection equipment described in this manual may not necessarily be self-evident and consequently equipment must be regularly inspected and maintained. Ion Science Ltd recommends that personnel responsible for equipment use a regime of regular checks prior to use to ensure it performs within calibration limits, and that a record be maintained which logs calibration check data. The equipment should be used in accordance with this manual, and in compliance with local safety standards.

IMPORTANT

It is essential that the TIGER^{LT} is always used with a supplied 0.5 micron PTFE Filter Disc fitted to the front of the instrument. Without a filter, particles of debris and dust can be drawn into the detector inhibiting the function of the instrument. These filters are consumable and should be changed after every 100 hours of use. The frequency of replacement should be increased for dusty or moisture laden environments. Filters are available from your distributor or at www.ionscience.com.

Quality Assurance

TIGER^{LT} has been manufactured in compliance with ISO9001:2008, which ensures that the equipment supplied to our customers has been designed and assembled reproducibly, from traceable components, and leaves Ion Science Ltd calibrated to stated standards.

Disposal

Dispose of TIGER^{LT}, its components and any used batteries in accordance with all local and national safety and environmental requirements. This includes the European WEEE (Waste Electrical and Electronic Equipment) directive. Ion Science Ltd offers a take back service. Please contact us for more information. The TIGER^{LT} field case material is recyclable polypropylene.

Calibration Facility

Ion Science Ltd offers a calibration service including the issue of certification confirming calibration with equipment traceable to national standards. A TIGER^{LT} calibration kit is available from your distributor or service centre or at www.ionscience.com. Ion Science Ltd recommends annual return of all instruments for yearly service and calibration.

Legal Notice

Whilst every attempt is made to ensure the accuracy of the information contained in this manual, Ion Science Ltd accepts no liability for errors or omissions, or any consequences deriving from the use of information contained herein. It is provided "as is" and without any representation, term, condition or warranty of any kind, either express or implied. To the extent permitted by law, Ion Science Ltd shall not be liable to any person or entity for any loss or damage which may arise from the use of this manual. We reserve the right at any time and without any notice to remove, amend or vary any of the content which appears herein.



Introduction to Tiger^{LT}

TIGER^{LT} is a portable gas detector that uses Photo-ionization technology to detect a large range of Volatile Organic Compounds (VOC's) which can be dangerous from both a poisoning and explosive perspective.

The TIGER^{LT} uses a Photo-Ionization Detector (PID) to measure gas concentrations. The patented fence electrode technology minimises the effects of moisture and contamination, avoiding the need for compensation.

Like its predecessor, the TIGER^{LT} also has an intuitive graphical interface allowing easy access to instrument settings. Two soft keys A and B can be configured to suit the user's application, so many functions can be selected without entering the main menu structure. This improves efficiency of use, particularly with repeatable tasks.

TIGER PC^{LT} (PC Software) maintains the intuitive look and feel by adopting the same graphical symbols. TIGER PC also helps manage logged data files and multiple instrument settings in a clear and concise way.

The TIGER^{LT} uses a Lithium-ion battery pack that not only boasts an impressive running time and short charge time, but also allows the battery pack to be replaced in potentially hazardous environments. Field replaceable alkaline battery packs (non-rechargeable) are also available for when power to recharge is unavailable.

The TIGER^{LT} has true USB capability so the instrument can be connected directly to a PC via a standard USB cable. It also offers fast data download.

A loud audio output, vibration and bright LED's indicate alarm conditions. Orange and Red LED's indicate High and Low conditions respectively. This colour scheme is used within TIGER PC^{LT} to offer clear indication of alarm levels within logged data.



Getting started

Thank you for choosing TIGER^{LT} from Ion Science Ltd. We hope that your TIGER^{LT} will give you many years of active and trouble-free service.

The Manual

Ion Science Ltd recommend that you familiarise yourself with this manual before using your TIGER^{LT}. The 'Statements' and 'Introduction to TIGER^{LT}' sections contain important information, which should be read before you turn your TIGER^{LT} on for the first time.

Inlet Probe

Ensure that the inlet probe supplied is fitted to your TIGER^{LT}. Details on how to fit and change inlet probe is detailed in the 'Maintenance' section. If the supplied inlet probe is unsuitable for your application, details of alternative inlet probe can be found in the 'Maintenance' section as well.

Turn On

Press the **Enter / On/Off** key once to turn TIGER^{LT} on.



Turn Off

Press and hold the **Enter / On/Off** key for 3 seconds, indicated by a 3 second countdown, to turn TIGER^{LT} off. (**Note:** If the TIGER^{LT} fails to shut down, press the **Escape (Esc)** key once or twice to return to the main screen, then press and hold the **Enter / On/Off** key again.)



Batteries

Check that your TIGER^{LT} has sufficient charge for use. The battery icon (see 'Understanding the display screen') should show at least two full segments.

Rechargeable Batteries

TIGER^{LT} instruments leave the factory with the Rechargeable Battery Pack (A2) fully charged. However prolonged periods of storage may result in the battery pack discharging. We recommend charging the instrument for seven hours before use. See the 'Batteries' section of this manual pages 33 to 35.

Alkaline Batteries

An alkaline AA Battery Pack (A3) can also be used with the TIGER^{LT}. For more information please see the 'Batteries' section of this manual.

Response Factor

TIGER^{LT} instruments leave Ion Science Ltd factory calibrated on isobutylene and with a response factor of (1.0). The reason we calibrate the instruments with a response factor of (1.0) is because this is the response factor of isobutylene.

Set Alarm Levels

We recommend that alarm levels are set to user specifications as soon as possible before the TIGER^{LT} is used for the first time. Please see the 'Using your TIGER^{LT}' section of the manual for details of how to set alarm levels.

TIGER PC^{LT}. The full functionality of your TIGER^{LT} can only be realised through the TIGER^{LT} PC software. Ion Science Ltd recommend that you load the software supplied with your instrument and set up your TIGER^{LT} according to the instructions in the 'TIGER PC^{LT} Software' section of this manual.



Understanding the keypad

General Description

The keypad comprises two soft keys: **A** and **B**, **Up** and **Down** arrow keys, an **Escape (Esc)** key, and an **Enter / On/Off** button. In general, setup and application settings are selected and adjusted via the soft keys, options are selected by the arrow keys and confirmed by the **Enter** key. A single press is used as a switching operation. A continuous press is used to adjust numbers or change gas selections by automatically rolling.

Keypad Function Descriptions



Soft keys **A** and **B** rely on graphical prompts on the display to indicate their functionality.



Up and **Down** keys are used to adjust settings and navigate through the menu structure.



Enter / On/Off key is used to accept adjustments and select functions; also to turn the TIGER^{LT} on and off.



Escape (Esc) key is used to abort an adjustment or exit from a menu.

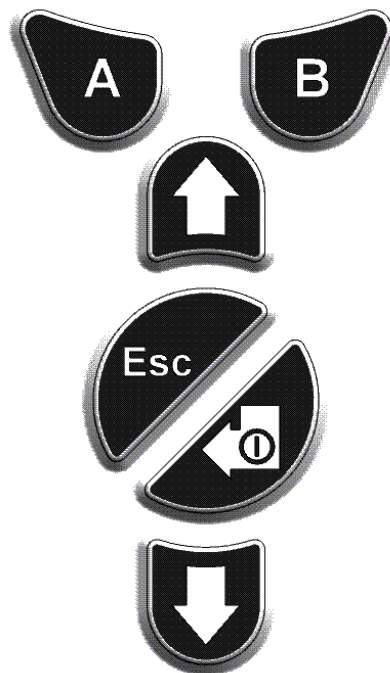



Understanding the display screen

Screen Display

The display is divided into four sections.

Fixed LCD Status icons fill the top of the screen offering instrument status at a glance. The icons display only when a function is selected. The main central viewing screen will display readings in large numbers only, 4 digits and decimal place will display 0.0 ppm to 5,000 ppm. Two soft key areas have been set aside as soft key indicators. The area between the soft key indicators displays the measurement units.



Status icon

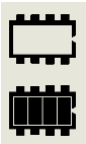

Memory Status: This icon only appears if the instrument has the data logging functionality. Four sections within the border fill as the data log memory is filled. Empty border = 100% memory available through to full, where all segments are present.



USB: The icon will appear when connected to a host device.

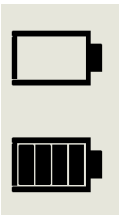

Battery Status: This icon consists of a border and four segments. The segments fill or empty to indicate 0-25, 26-50, 51-75 and 76-100% full. When discharging, the border will flash for 1 minute before the instrument shuts down. When charging, the segments will successively fill until 100% charge is reached.



Understanding the display screen



Backlight: Light beam lines appear when the backlight is on.



Sound: The main body of the icon is present at all times. The disable lines appear if all 3 alarm sounders are disabled and the volume is at 0%. Three sound projection lines indicate the volume level. However there are four sound levels and the quietest level has no line.



Alarm Bell: The icon consists of 2 parts, the Bell and the sound bars. When the instrument reaches a 'Low alarm' the Bell and one sound bar will flash; when a 'High alarm' is reached the Bell and both sound bars flash.



Flashlight / Torch: When the flashlight / torch is illuminated the light beams appear.

Main Screen Area

During normal operation this area displays the readings in large numbers, with the units of measurement below. During setup and adjustment, a function bar overlays the main screen.



Understanding display screen

Soft key areas

The following icons will appear in the soft key areas as soft key options. They are selected using the **Up** and **Down** keys. Those labelled 'optional' will only appear if your TIGER^{LT} has that functionality. These icons can be reorganised using the TIGER^{LT} PC software.

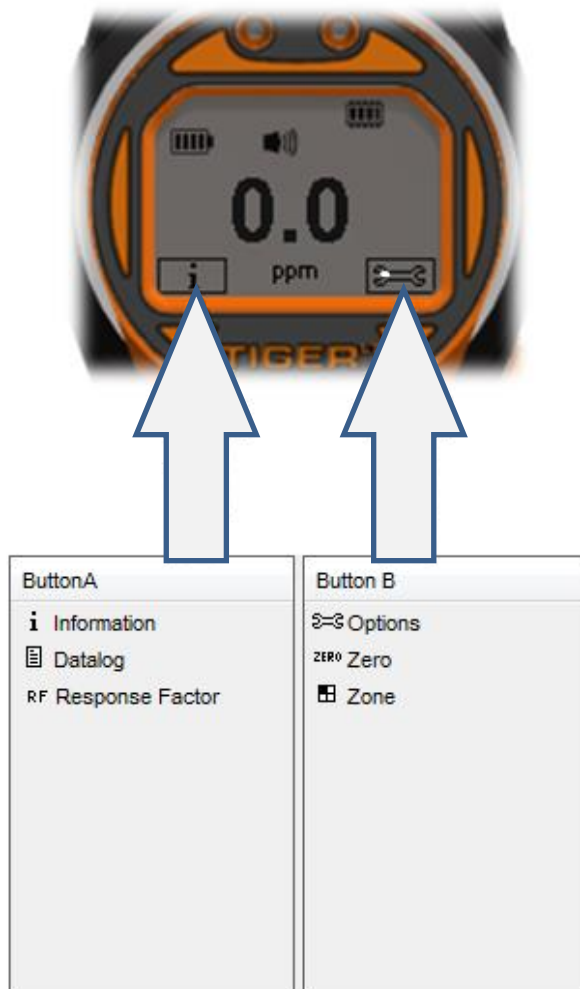

Button A

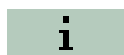

Information



Single Data Log



Response Factor

Button B



Options

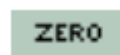

Zeroing



Zones



Using your Tiger^{LT}

Instrument functionality is broken into two parts; Application and Setup. Application settings are initially selected via the soft keys **A** and **B**. Setup functions like Backlight, Sound, Calibration and Alarm setting are adjusted within **Options**. Many of the screens have a 2 second time out which returns to the main screen if no other keys are pressed.



On

To switch the TIGER^{LT} on press the **Enter / On/Off** key once. Startup screen 1 appears showing the TIGER^{LT} logo. Startup screen 2 contains variable text sent from the TIGER PC^{LT} configuration screen. The lower half of the screen contains the instrument IRN (Internal Reference Number) and firmware version. The third screen shows TIGER^{LT} checking that the lamp has 'struck'. When 'OK' appears, the working screen will follow. If the lamp fails to strike, turn the TIGER^{LT} off, wait for 30 seconds and try again. If the problem persists, change the lamp or contact Ion Science Ltd or your distributor.



Off

To switch the TIGER^{LT} off press and hold the **Enter / On/Off** key. A 3 second count down takes place before the instrument shuts down. During this count down the instrument activates the upper alarm. Red LED's flash and audible alarm sounds. This is done to alert the user to avoid accidental switch off.

Zeroing

Pressing the **Zero** soft key presents two zero options  selected with the **Up** or **Down** keys. The upper symbol represents an absolute zero. The lower symbol represents a relative zero which follows the drift of the PID detector. Having made your selection, press **Esc**. If the relative zero has been selected TIGER^{LT} will zero itself before returning to the main screen.

Zones

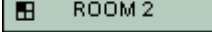
Press the **Zone** soft key to display the currently selected Zone:  The TIGER^{LT} is defaulted to 'Zone 1'. Zones are set up in TIGER^{LT} PC only and the name given to the zone(s) will appear on the screen. Use the **Up** and **Down** keys to select alternative zones.

Single Data Log (optional)

Press the **Single Data Log** soft key to take a single data log reading. The single data log symbol appears with a tick:  and then returns to the main screen. Press the **Single Data Log** soft key again to take another reading. The fixed LCD memory icon flashes off when a single log is taken.

Options

Press the **Options** soft key to give access to various adjustable features, selected with the **Up** and **Down** keys. Press **Enter** to confirm selection.



Backlight

Four options are presented: 'Permanently Off', 'Permanently On', 'On in low ambient light' and 'Timed' (Set the time in TIGER PC^{LT}). Select the preferred option with the **Up** and **Down** keys and confirm with **Enter**.



Using your Tiger^{LT}



Sound

The sound options are presented as set up in TIGER PC^{LT}. Use the **Down** key to select either keypad beep, alarm sound, crescendo or percentage volume. Press **Enter** to turn selection on or off. For percentage volume, press **Enter** again to confirm selection. The frame will flash. Use **Up** and **Down** keys to change the percentage volume and press **Enter** to confirm the chosen value. Press **Esc** twice to return to the main screen.



Calibration

Only two options are presented: Factory Calibration and Custom Calibration. Select the preferred option with the **Up** and **Down** keys and confirm with **Enter**. Whichever calibration standard is selected, the TIGER^{LT} will operate against that calibration. Readings taken against unsatisfactory calibrations may be unreliable.



Factory Calibration

Not for operator use.

Users can set their instruments to operate using the factory calibrated values, however, the actual calibration function cannot be carried out by the user. The instrument must be returned to Ion Science Ltd or an authorised service centre for factory calibration.



Custom Calibration

see the 'Maintenance' section of the manual



Alarms



Upper



and Lower

alarm settings are displayed. Select the subject alarm using the **Up** and **Down** keys and press **Enter**. The arrow(s) on the chosen alarm will flash. Adjust the level using the **Up** and **Down** keys and press **Enter**. Repeat, if necessary for the other alarm. Press **Esc** twice to return to the main screen.

Note: The Lower alarm setting must never be greater than the Higher alarm.



Information

Pressing the **Information** soft key allows access to a number of other information screens. Use the **Down** key to scroll through the screens. Press **Esc** to return to the main screen:



Using your Tiger^{LT}

1st Screen	Response Factor	RF
	Low alarm	↑
	High alarm	↑↑
2nd screen		
	Date of Factory calibration	E
	Date of Custom calibration	E
3rd Screen	SPAN 1	SPAN 1 (gas concentration set in TIGER PC ^{LT})
	SPAN 2	SPAN 2 (gas concentration set in TIGER PC ^{LT})
	PID	PID (PID reading)
	A/D	A/D (Digital number from PID)
4th Screen	IRN	IRN: Internal reference number
	Firmware	Firmware: Version
	Bootloader	Bootloader: Version
	Battery	Type and voltage
5th Screen		
	Data log memory available	
	Date / time	



Tiger PC^{LT} software installation

The Tiger^{LT} PC has its own specific software package used to set up the instrument and download logged data. The software is available to download from the [Ion Science](http://ionscience.com) website. Once the software is downloaded from the website, double click on the zip file and follow the installation procedure.

Using Tiger PC^{LT} software

Connecting TIGER^{LT} to a PC

1. Double click the TIGER^{LT} icon on your desktop and open TIGER^{LT} PC.
The Home page should appear:

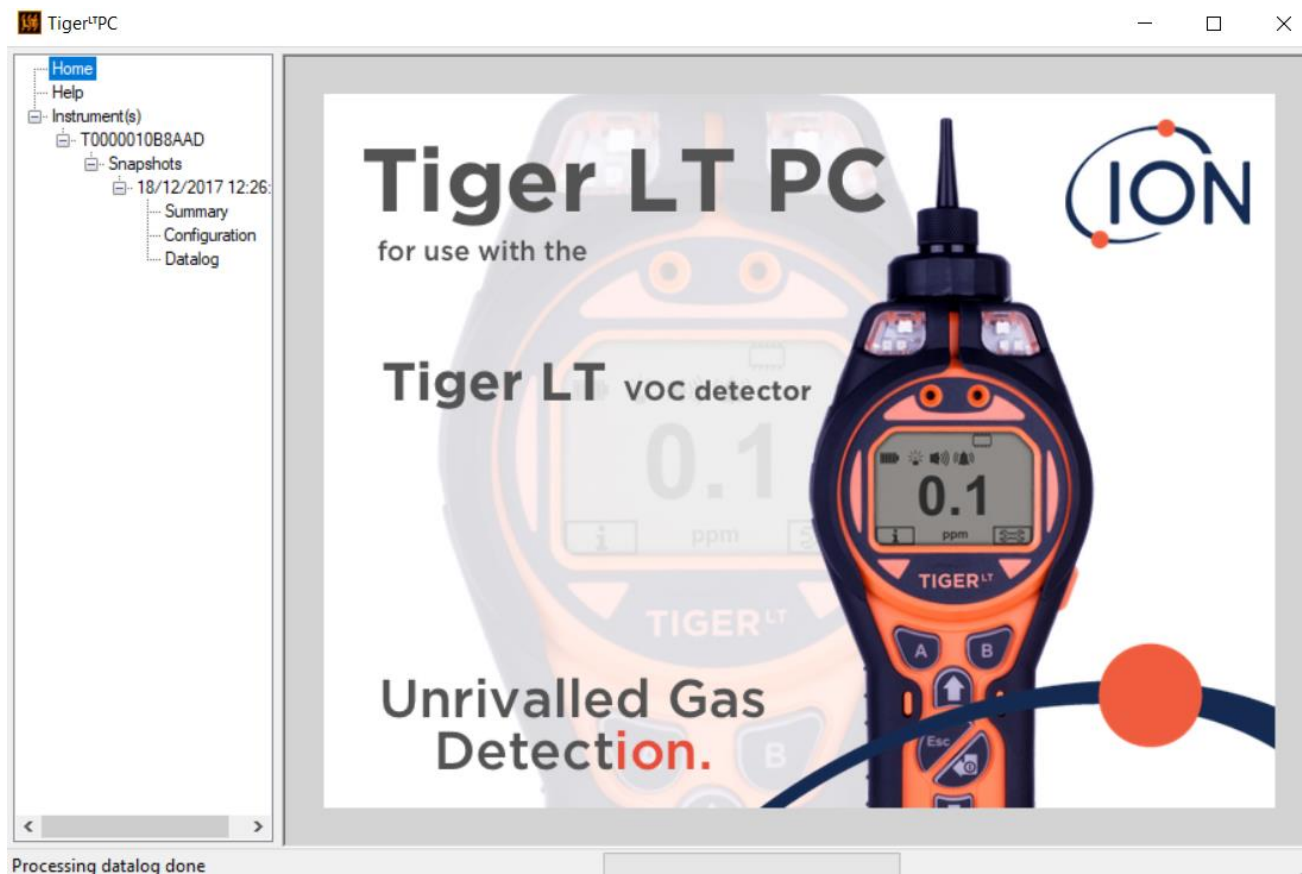



Tiger PC^{LT} software

The Help Screen

This screen will show you if a new version of PC software is available. You can then install the upgrade if required.

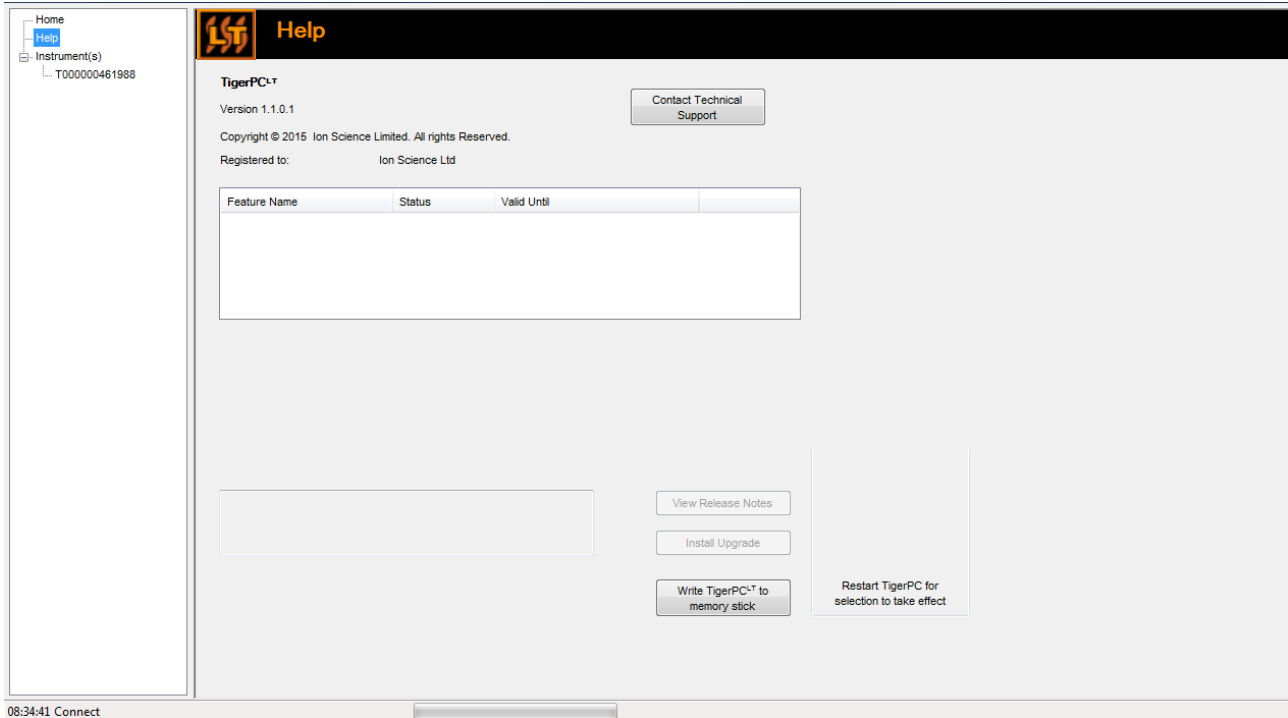

- Click on 'Instrument(s)'. If your TIGER^{LT} has previously been connected to your PC your instruments IRN (Internal Reference Number) will appear.

Note: If, while using this software your TIGER^{LT} should inadvertently be turned off or disconnected from your computer, click on 'Instrument(s)' again and proceed as below:

- Switch TIGER^{LT} on and when fully running up connect to a USB socket on your PC using the USB cable supplied. If the 'Found New Hardware' screen appears, follow the prompts to install your instrument on your PC.
- Click on 'Read'. Your instrument number will appear under 'instrument(s)' (if it was not there already) and the Instrument Summary page will appear.



Tiger PC^{LT} software

The screenshot shows the TigerPC software interface. On the left is a navigation tree with 'Home', 'Help', 'Instrument(s)', 'T000000461988', 'Configuration', 'Logo', 'Firmware', 'Datalog', 'Service', and 'Snapshots'. The main area contains the text 'Please connect an instrument to a USB port and press 'Read''. Below this is a blue 'Read' button. Underneath, there is a text box containing 'T000000461988' and a grey 'Delete' button. At the bottom left, a status bar says 'Processing datalog done' with a green progress bar.

This screenshot shows the same software interface as above, but with more data displayed. The 'Read' button is now disabled. A text box lists the following information for instrument T000000461988: Summary - OK, Features - OK, Config - OK, Logo - File not found, Factory Cal - OK, User Cal - none, TigerSelect Cal - none, Firmware - OK, and Datalog - OK. A dialog box titled 'TigerPC^{LT}' is open, asking 'Would you like to create a snapshot of your instrument? This may be used in future to recover your instrument'. It has 'Yes' and 'No' buttons. The status bar at the bottom still shows 'Processing datalog done' with a green progress bar.



Tiger PC^{LT} software

- This page gives the current status of your TIGER^{LT}. If the 'snapshot' screen appears click 'Yes'. You can delete the snapshot later if you wish (see 'TIGER PC^{LT} Software').

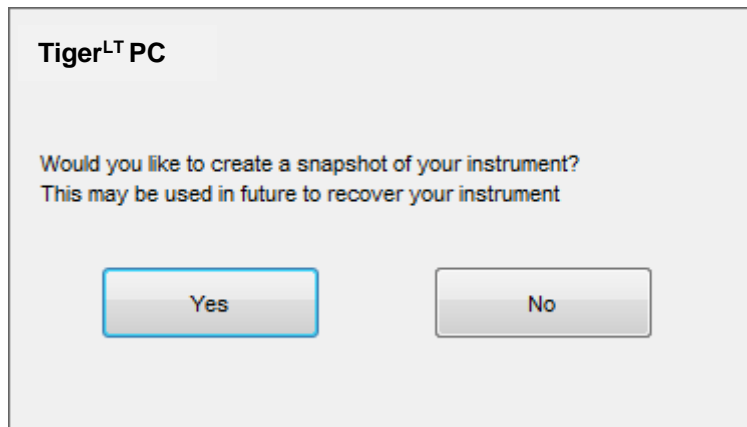

Summary Screen

The Summary screen shows the current status of your Tiger LT, including IRN, firmware version, run time and calibration data.

Tiger^{PC}

- Home
- Help
- Instrument(s)
 - T0000010B8AAD
 - Snapshots
 - 18/12/2017 12:26
 - Summary
 - Configuration
 - Datalog

Instrument Summary

T0000010B8AAD

IRN	T0000010B8AAD	
Startup Text	Natalie's Tiger LT	
Run Time	34 hours 02 minutes	
Firmware Version		
	V0.5.12	
Datalog Used		
	<div style="width: 100%; height: 10px; background-color: gray;"></div>	
File System Remaining		
	<div style="width: 80%; height: 10px; background-color: green;"></div>	
Clock		
	18/12/2017 12:27:53	

Factory Calibration		
Calibration Date	25/07/2114 19:12:08	
Response Factor	1.0	
	Low Gain	High Gain
Zero A/D Reading	308100	308064
102.4 ppm A/D Reading	580337	7671507
5100 ppm A/D Reading	9067782	

Custom Calibration		
Calibration Date	14/07/2017 16:26:36	
Response Factor	1.0	
	Low Gain	High Gain
Zero A/D Reading	308146	308074
102.4 ppm A/D Reading	588630	7894516
1003 ppm A/D Reading	2576655	



The Configuration Screen

Use this screen to configure your TIGER^{LT}.

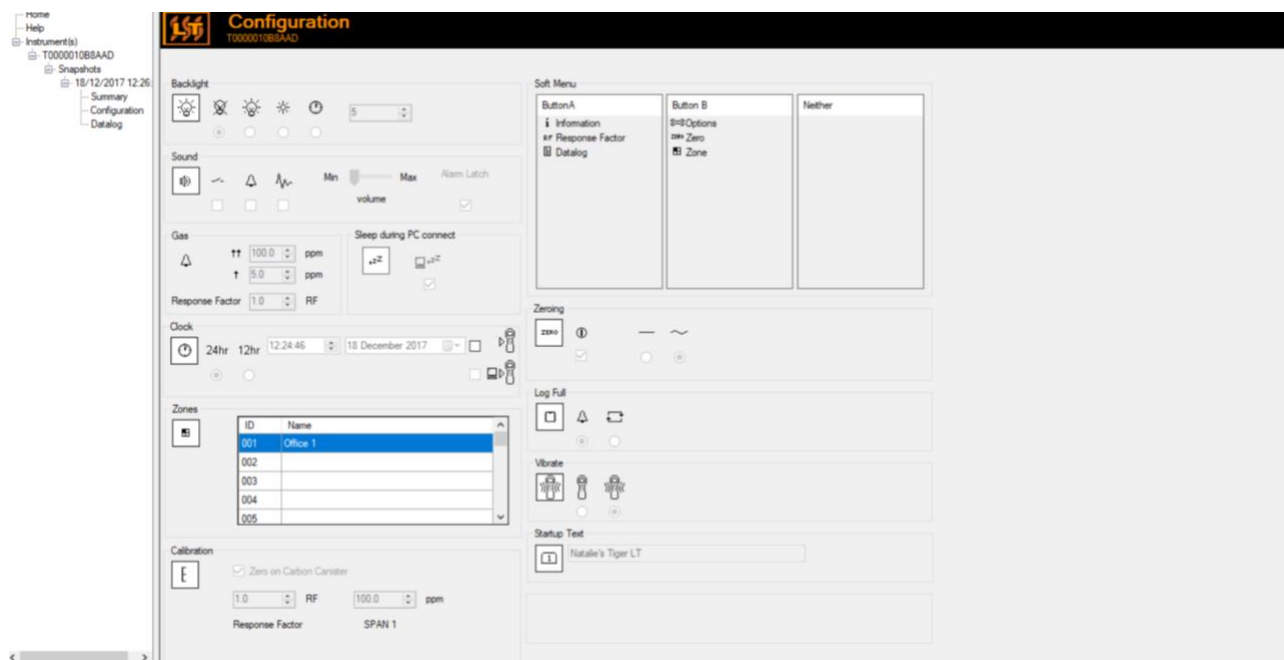

Tiger^{LT} PC software

Backlight

Choose from 'Permanently Off', 'Permanently On', 'On in low ambient Light', or 'On For Limited Time'. The Backlight Timeout can be set from 1 to 30 seconds.

Sound

The three icons represent: key press; alarm; and crescendo. Crescendo increases the sound as the upper alarm is approached. Sound on each of these may be enabled or disabled by ticking or un-ticking the box. Sound volume is adjusted with the slider.

Gas

This allows users to set the two alarm levels, a lower and higher alarm to the user's preference. In this option it also allows the user to select the response factor for the instrument.

Sleep during PC connect

Sleep during PC connect will send the instrument into sleep mode while it is connected to the PC software. The instrument will awaken as soon as it is disconnected from the PC software.

Clock

Select 24 or 12 hour format using the radial buttons. Set the time and date and tick the box on the right to set the time on your TIGER^{LT}. Alternatively, tick the lower box to synchronise your TIGER^{LT} with the time on your computer.



Zones

Use this table to define and name up to 128 separate zones. The name field is limited to eight characters including spaces.

Calibration

Zero on Carbon Canister

1.0 RF 100.0 ppm

Response Factor SPAN 1

Soft Menu

The various functions may be allocated to the soft buttons in any order of preference by dragging and dropping the icons. (see page 12)

Zeroing

This function allows either an assumed constant zero or for the zero to be tracked compensating for the shift in the zero of the PID lamp during operation. The function may be enabled or disabled by ticking or un-ticking the box. Constant or tracked zero is selected by use of the radio buttons associated with the icons.

There are various options for zeroing a TIGER^{LT}. The symbols below are found on the configuration screen of TIGER^{LT} PC.



Tiger PC^{LT} software

Zero at switch on

When selected, the TIGER^{LT} will automatically set its zero reading based on ambient air. When deselected, the TIGER^{LT} uses the Custom or Factory calibration Zero depending on which is selected.

Fixed zero

When selected, TIGER^{LT} uses the fixed calibration Zero. If used in conjunction with the 'Zero at switch on' feature the instrument will zero at switch on and then remain at that level.

Zero tracking

When selected, the Zero level will move negative if a cleaner ambient air is detected. This ensures 0.0 ppm is displayed in clean air and ensures sub ppb levels are always detected.

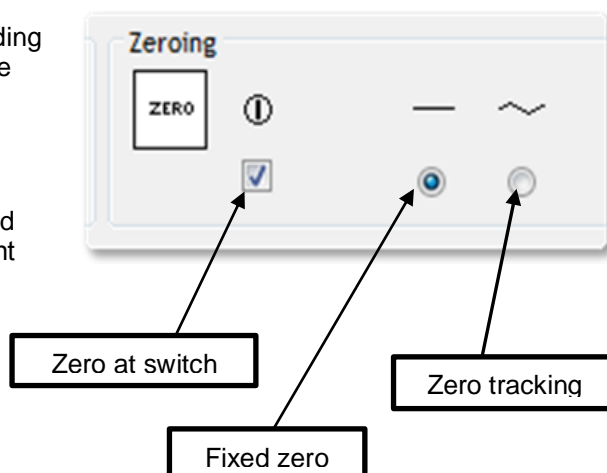

Log Full

If you select the bell symbol your TIGER^{LT} will alarm when the memory log is full. Alternatively, if you wish new data to overwrite the oldest stored data in the memory and continue to store new data during data-logging, select the recycle symbol.

Vibrate

To set your TIGER^{LT} to vibrate under alarm conditions select the 'vibrate' symbol.

Calibration

Use this area to define your Custom Calibration parameters.

First connect TIGER^{LT} to your PC as detailed above under 'Connecting your TIGER to a PC'.

TIGER PC^{LT} offers a two-point calibration (zero + span). Send this information to your TIGER^{LT}. The calibration procedure is detailed under the 'Maintenance' section of this manual.

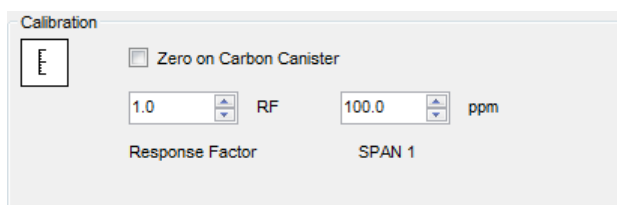

Startup Text

Enter the text you wish to appear on the startup screen of your TIGER^{LT}.

Send to Instrument

When you have configured your instrument or completed your changes, send them to your TIGER^{LT} by clicking the 'Send to Instrument' box. If the message 'There was a problem sending to the instrument' appears, click OK and return to the Home screen. Repeat the procedure under 'Connecting your TIGER^{LT} to a PC' above. If the 'Summary' screen for your TIGER^{LT} appears, visit the configuration screen again. If not, repeat the entire procedure. If your PC still fails to read or write to your TIGER^{LT} seek advice from your distributor or from Ion Science Ltd.



Tiger^{LT} PC software

The Firmware Screen

This screen displays the current firmware version installed on your TIGER^{LT}. It also provides a facility to download updated versions to your TIGER^{LT}.

At this point you can also check the 'View Release Notes' information which is a description of the changes in the new version as shown here.

To download a firmware update, connect TIGER^{LT} to your computer as detailed previously. Ensure that your instrument is in normal Survey mode, is not in an alarm condition and that no datalogging or Health and Safety readings are being collected. Check that the battery pack is sufficiently charged (at least two bars).

IMPORTANT: The 'Firmware' upgrade process will delete all data from the instrument. To avoid loss of any data during the upgrade process, take a snapshot of the instrument before proceeding. The snapshot can be re-installed after the update process is complete.

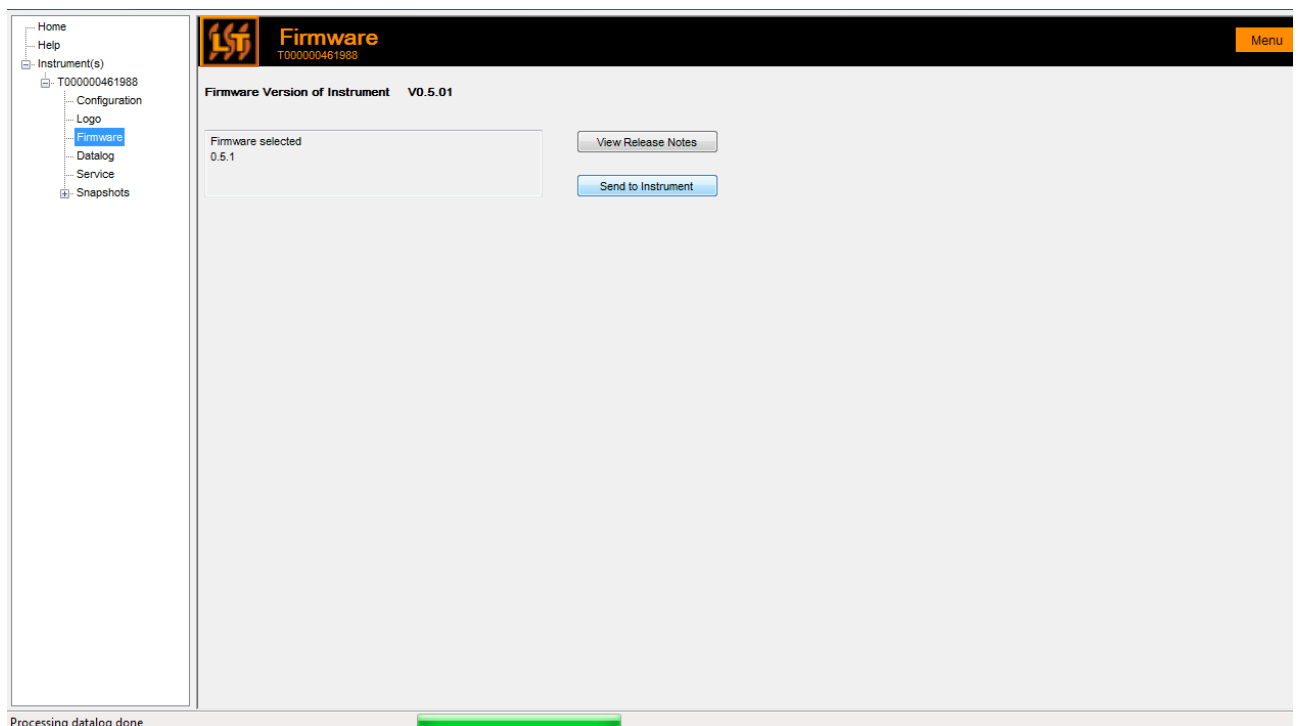

When you are ready to send the new Firmware to the instrument. Select 'Send to Instrument'.

You will now see a message that will warn you that all the data will be lost on your instrument. If this is acceptable to continue confirm with 'Yes'.

A 'WARNING' message will appear, to continue select 'Yes'.



Tiger PC^{LT} software

IMPORTANT: Do not attempt to operate your TIGER^{LT} during the update process.

The firmware on your TIGER^{LT} will be updated and the new version will be shown on the 'Firmware' screen.

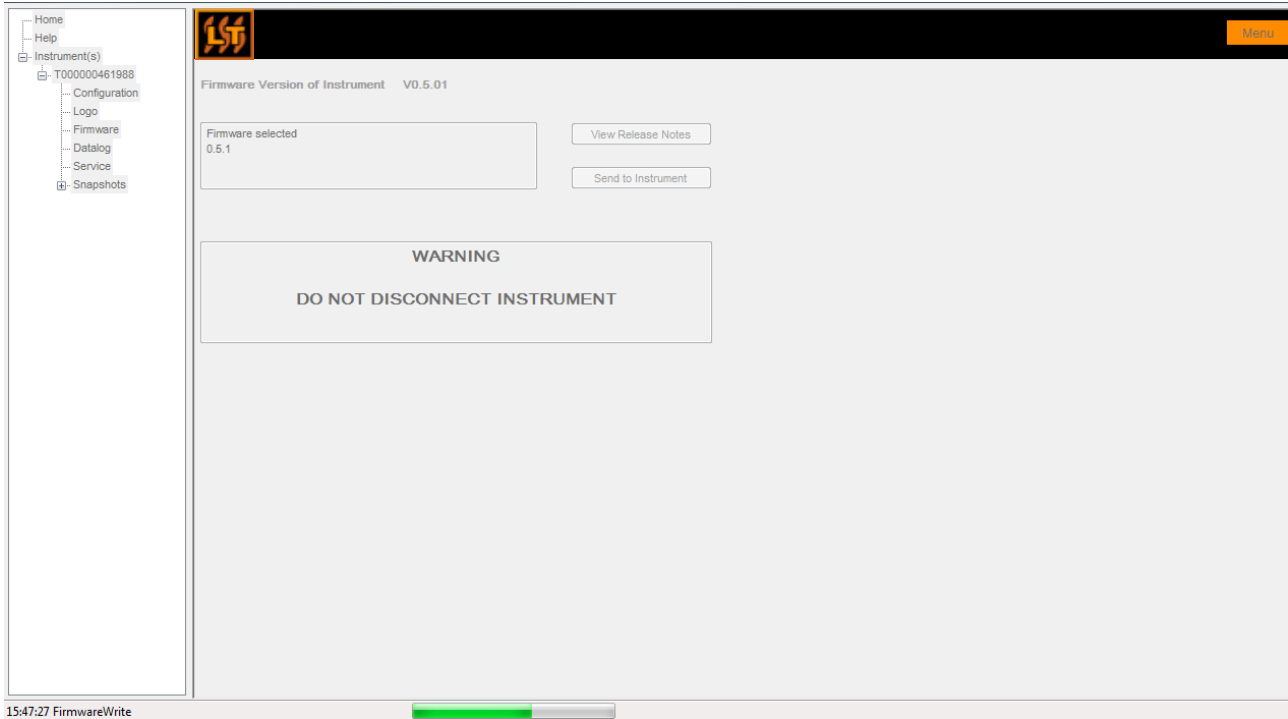

A bar at the bottom of the screen will indicate the progress of the update.

IMPORTANT: Do not disconnect the TIGER^{LT} at this point. Please follow the next part before disconnecting the TIGER^{LT}.

After the PC Software has completed sending the upgrade to the TIGER^{LT} the instrument will then have to finish the upgrade process. The TIGER^{LT} will flash the two torch LED's and the screen on the Tiger^{LT} will remain blank for approximately 30 Seconds. A bar will then appear and travel across the screen. A message will be displayed as follows, 'verifying file system'. The Firmware is now installed on to the instrument and will start up automatically.





Tiger PC^{LT} software

Downloading Data Logged Readings

Connect your TIGER^{LT} to your PC as described previously. Any fresh data-logged readings will be downloaded as the software 'reads' your TIGER^{LT}.

Go to the datalog screen and a list of the datalog sessions is presented.

The screenshot shows the Tiger PC^{LT} software interface. On the left is a navigation tree with the following items: Home, Help, Instrument(s), T000000461988, Configuration, Logo, Firmware, Datalog (highlighted), Session 0, Service, and Snapshots. The main window title is 'Datalog Sessions' with the LST logo and the instrument ID 'T000000461988'. A 'Menu' button is in the top right corner. The main area contains a table with the following data:

Session No	Zone	Start Date	Gas
0	001	01/05/2015 09:08:37	Gas (1.0)

At the bottom left of the window, a status bar indicates 'Processing datalog done' with a green progress bar.

Expand the datalog folder and select the session of interest.

Details of the data collected during that session are presented in numerical and graphical form.

Use the menu function at the top right hand corner of the window to print, export or delete the data.

CAUTION:

The delete function deletes all logged data from your TIGER^{LT}. Ensure all valuable data is exported to your PC before selecting 'Delete'.



Tiger^{LT} PC software

Snapshots Screen

A snapshot records the settings and calibration data on your TIGER^{LT} at any particular point in time. The 'Snapshots' screen displays a list of all those stored on your PC.

Click 'Delete' to remove a selected snapshot.

To restore the stored settings to your TIGER^{LT}, first ensure that your instrument is running correctly and connected to your PC as detailed previously. Ensure that your instrument is in normal Survey mode, is not in an alarm condition and that no data logging or Health and Safety readings are being calculated. Click 'Restore' against the relevant snapshot

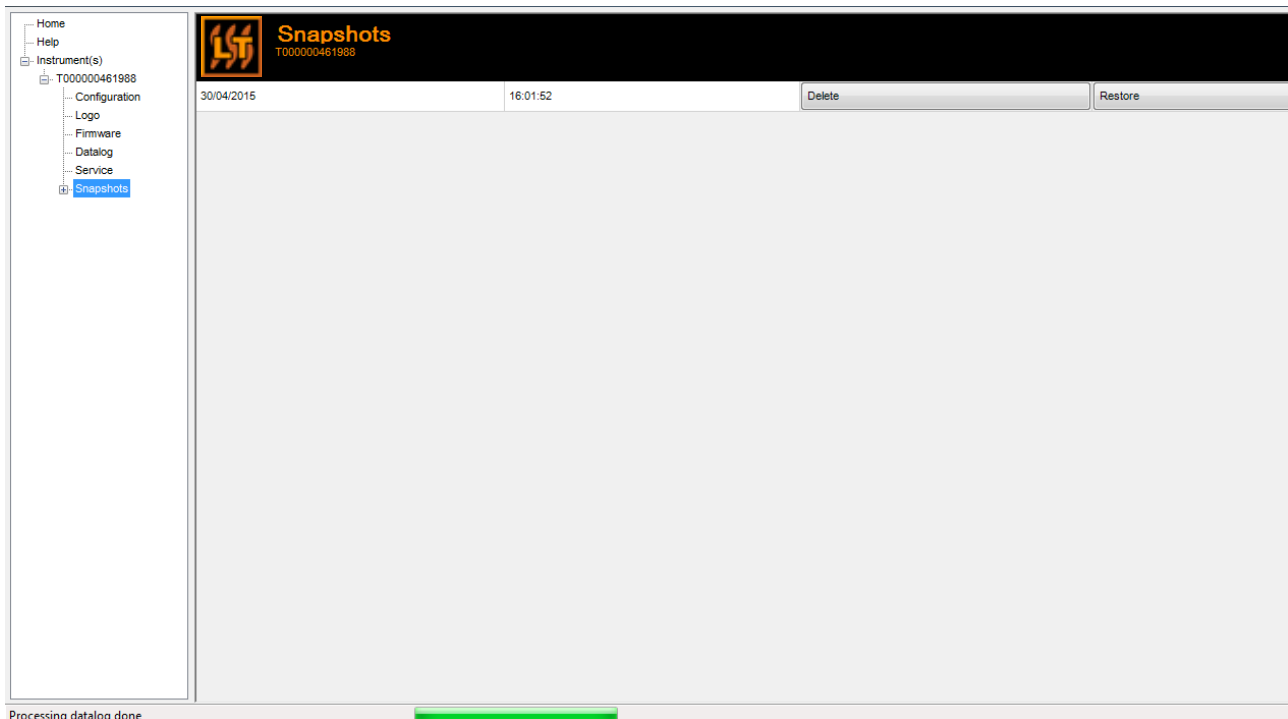

Be aware that this process will replace all setup and calibration files

On the restore screen click 'Yes'. When complete, click 'Close' and restart your TIGER^{LT}. Your TIGER^{LT} will now be restored to the settings and calibration data stored at the time of that snapshot.

The snapshot menu also allows review of stored data when an instrument is not attached.

Expand the menu until the latest or relevant snapshot is displayed. Double-click on the snapshot and all the data stored in that snapshot can be accessed.



Tiger^{LT} PC software

Software Disclaimers

Termination of Software Licence

This License is effective until terminated. This License will terminate automatically without notice from Ion Science Ltd if you fail to comply with any provision of this License. Upon termination, you agree to destroy, delete or purge the written materials and all copies of the SOFTWARE, including modified copies, if any.

Disclaimer of Warranty

The SOFTWARE and accompanying materials (including the user's manual) are provided "as is" without warranty of any kind including the implied warranties of merchantability and fitness for a particular purpose, even if Ion Science Ltd have been advised of that purpose. Furthermore Ion Science Ltd does not warrant, guarantee, or make any representation regarding the use, or the results of the use, of the SOFTWARE or written materials in terms of correctness, accuracy, reliability, current revision, or otherwise. Ion Science Ltd specifically does not warrant the SOFTWARE after you assume operation. If the SOFTWARE or written materials are defective you, not Ion Science Ltd or its dealers, distributors, agents, or employees, assume the entire risk and costs of all necessary servicing, repair, or correction, except as stated below.

Defective Memory Stick

As the only warranty under this Agreement, Ion Science Ltd warrants, to the original Licensee only, that the Memory Stick(s) on which the software is recorded is free from defects in materials and workmanship under normal use and service for a period of ninety (90) days from the date of delivery as evidenced by a copy of the Receipt. This limitation will apply where allowed.

Replacement of Defective Memory Stick

Ion Science Ltd entire liability and the original Licensee's exclusive remedy under this agreement are at the discretion of Ion Science Ltd, to either (a) return of payment as evidenced by a copy of the Receipt, or (b) replacement of the memory stick that does not meet Ion Science Ltd limited warranty and which is returned to Ion Science Ltd with a copy of the Receipt. If failure of the memory stick has resulted from accident, abuse, or misapplication, Ion Science Ltd will have no responsibility to either replace the item or refund payment. Any replacement memory stick will be warranted for the remainder of the original warranty period or thirty (30) days, whichever is longer. This warranty gives you limited, specific legal rights. You may have other rights in some places.

No Right to Reply

No oral or written information or advice given by Ion Science Ltd, its dealers, distributors, agents or employees will create a warranty or in any way increase the scope of the obligations of Ion Science Ltd under this agreement, and you may not rely on any such information or advice.

Limitation of Liability

Ion Science Ltd will not be liable for any direct, indirect, consequential or incidental damages (including damages for loss of business profits, business information, or possibility of such damages). The above limitation will apply where allowed under local laws.

Governing Law

The laws of the United Kingdom govern this Agreement.



Batteries

Warnings

BATTERY CHARGING:	Charge TIGER and its Lithium ion battery packs in a Non Hazardous environment only.
BATTERY REPLACEMENT:	Never replace primary Alkaline battery cells while in a potentially explosive or hazardous location. Use only Duracell Procell Alkaline batteries MN1500.
BATTERY CONNECTION:	The TIGER Lithium ion and Alkaline battery packs have been specially designed to allow connection to the TIGER Instrument while in potentially hazardous atmospheres. The TIGER instruments ingress protection rating is reduced to IP 20 when its battery pack is removed so avoid changing batteries in dusty or wet environments.

Two battery packs are available for use with the TIGER^{LT} instrument. A lithium ion Rechargeable Battery Pack (**A2**) and non-rechargeable AA Battery Pack (**A3**), (that may be fitted with 3 AA Alkaline batteries). The rechargeable pack is recommended for normal operation with the non-rechargeable pack available when power is not available and the use of the instrument is needed. The rechargeable pack is normally fitted as standard to the instrument when shipped.

Recharging Batteries

Ensure the TIGER^{LT} is charged for at least 7 hours before using it for the first time. To ensure optimum charging the TIGER^{LT} should be switched off during charging. If left on, the TIGER^{LT} will take longer to charge, but should not suffer any damage. The TIGER^{LT} should be charged in a non-hazardous environment only.

To charge your TIGER^{LT}, first connect the Charger Cradle (**A4**) to the mains, and switch on. A red light will indicate that the charger is ready. Place the TIGER^{LT} in the Charger Cradle such that the contacts on the TIGER^{LT} are aligned with those in the cradle. (There is no need to remove the Instrument Boot (**8**) from the TIGER^{LT} during charging.) During charging, the charger will display an orange light. A green light indicates that charging is complete.

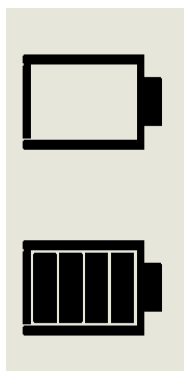

Discharged

The battery icon on the TIGER^{LT} will display the level of charge.

Fully Charged

- Note:**
1. Only use the Charger Cradle supplied with your TIGER^{LT} to charge your instrument.
 2. Ion Science Ltd recommends keeping your TIGER^{LT} on charge at all times when not in use, as batteries can lose power over time.



Batteries

Replacement / Exchange of Battery Packs

To replace the Rechargeable Battery Pack (**A2**), proceed as follows:

- a. Ensure TIGER^{LT} is switched Off;
- b. Remove the Instrument Boot (**8**) from your TIGER^{LT} (this is most easily achieved by starting at the front end of the instrument (step 4 below));
- c. Release the clip at the rear end of the instrument and lift the Rechargeable Battery Pack (**A2**) away from the Instrument Body (**A1**), coincidentally sliding it slightly backwards;
- d. Reverse the procedure to install the replacement battery pack ensuring that the Boot is a snug fit around the front of the instrument and the lights are not obscured;
- e. Charge the TIGER^{LT} for 7 hours before use.

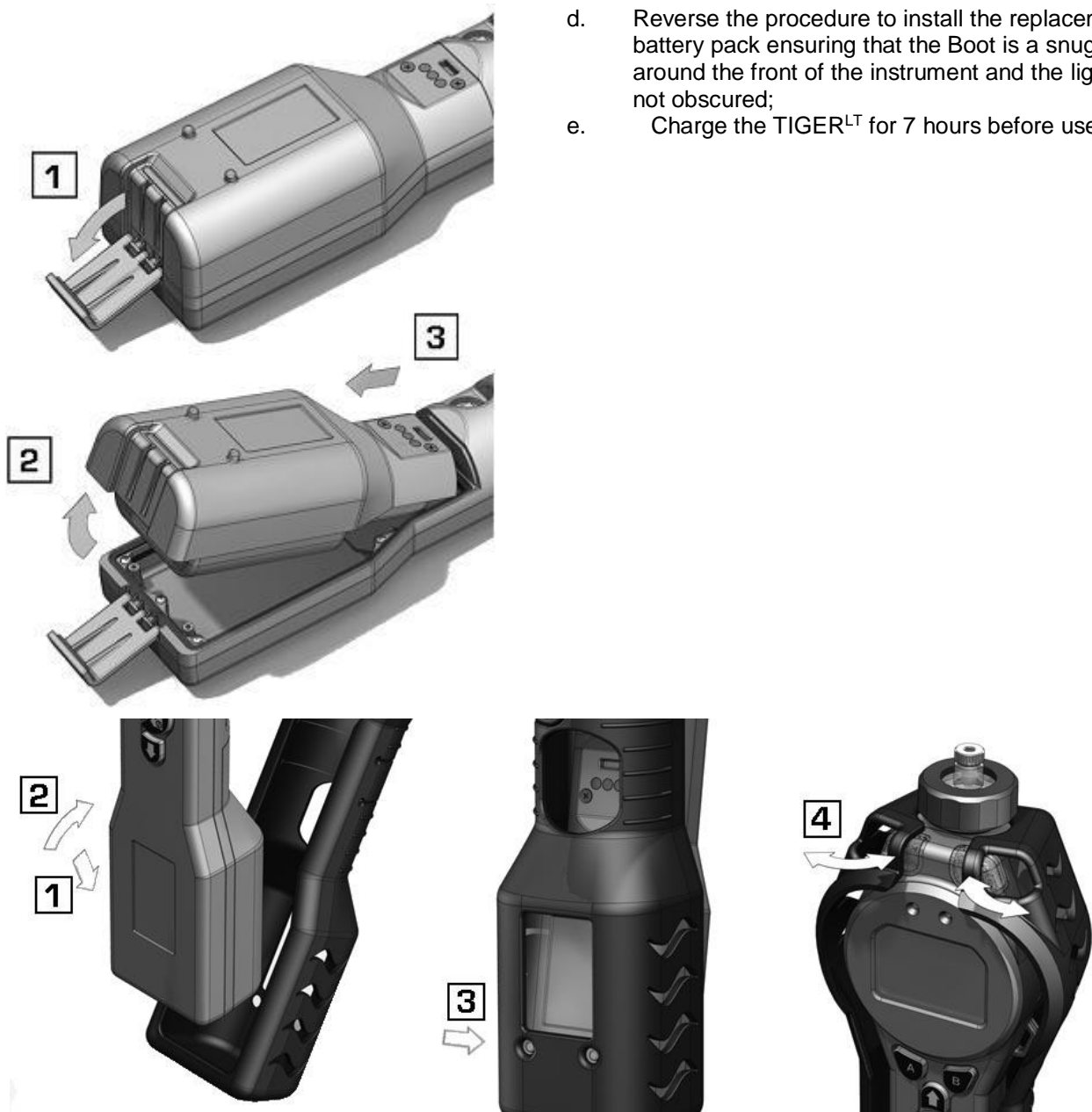

Item numbers in (bold) refer to the illustrations and parts list on page 41.



Batteries

Replacement of Non-rechargeable Batteries in Battery Pack

WARNING

BATTERY REPLACEMENT: Never replace primary Alkaline battery cells while in a potentially explosive or hazardous location. Use only Duracell Procell Alkaline batteries MN1500.

- a. Ensure TIGER^{LT} is switched Off.
- b. Remove the AA Battery Pack (**A3**) as in (b) and (c) on page 34;

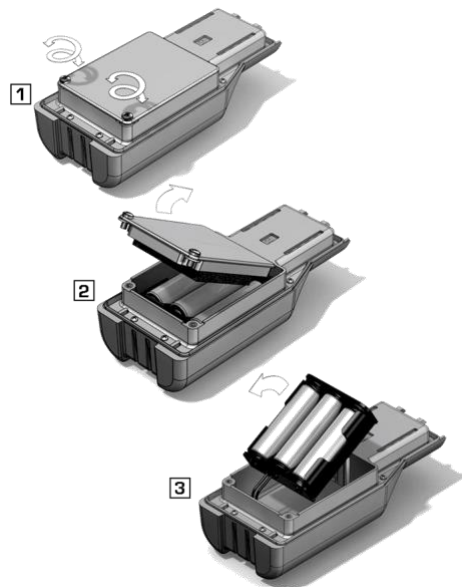

- c. Remove the screws retaining the battery cover and lift it off. This reveals a set of 3 x AA cells contained in a removable battery holder;
- d. Remove the battery holder;
- e. Replace the exhausted batteries; Use Duracell PROCELL Alkaline batteries MN1500
- f. Check all batteries have the correct polarity before replacing the battery holder;
- g. Assemble the battery holder into the AA Battery Pack (**A3**), refit the battery cover and fix in place using the securing screws. Replace the Instrument Boot (**8**) ensuring that it is a snug fit around the front of the Instrument Body (**A1**) and the lights are not obscured.

CAUTION:
Fitting batteries or connecting the battery pack with the wrong polarity may result in permanent damage to the instrument!

CAUTION:
Non-rechargeable batteries must not be replaced in the field. Batteries should be loaded into the battery holder in a safe environment only. Only the assembled AA Battery Pack (**A3**) may be changed in the field.

CAUTION:
Do not make any connections to the USB port of this instrument whilst in a hazardous area.

Note: When loading batteries check for correct battery polarity before connecting them.

Note: Dispose of used batteries in accordance with all local and national safety and environmental requirements.



Diagnostics

Basic faults or diagnostics are presented as symbols. Should a fault occur most can be corrected by pressing **Enter** or **Esc** to clear the fault message. All fault conditions cause the TIGER^{LT} to alarm.

Pump failure



Pump blocked or pump failure

The flow of gas through the instrument has fallen below 50 ml/minute. Check the probe and filter for signs of blockage. Water or dirt in the probe, a bent probe, dirty filter on the inlet or blockage of the exhaust (finger over hole on the back?) can all cause low flow. If the blockage can be removed, press **Esc** to clear the alarm. If the fault persists send the instrument to your distributor for service.

Battery dead

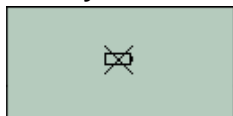

Battery low or battery failure

The TIGER^{LT} will shut down when the battery level falls below 2%. Recharge the battery as instructed in the 'Batteries' section of this manual ensuring that all connections are sound and the indicator lights on the charger are in order. If the battery fails to charge, fit another battery pack if available. If using alkaline batteries, replace them. If the fault persists send the instrument and charger to your distributor for service.

Lamp out



Lamp failure

The PID lamp has failed to strike (illuminate); this may occur at switch on or during use. Switch the TIGER^{LT} off and replace the lamp. See the 'Maintenance' section.

Memory full



Memory cannot receive more data

The data log memory is full. This will only happen if the Log Full box is set to 'alarm' on the TIGER^{LT} PC configuration screen. Press the **Esc** key to continue, but the TIGER^{LT} will no longer continue to log data. Select 'recycle' in TIGER PC^{LT} and the TIGER^{LT} will overwrite the oldest data and no alarm will be raised.

System error



Total system failure

The instrument's firmware is corrupted. In the unlikely event of this message appearing, contact Ion Science Ltd or your nearest authorised service centre.



Maintenance

Calibration

Ion Science Ltd recommends an annual service and calibration for users who require a traceable calibration. During this service the lamp and detector are brought back to factory specifications and new Factory Calibration data is stored.

Due to the linear output of the Ion Science PID detector, a two-point calibration is often adequate. TIGER^{LT} scales its linear output across a ZERO level (clean air reference) and the SPAN 1 user defined gas concentration.

TIGER^{LT} offers the options of Factory Calibration or Custom Calibration. 'Factory Calibration' is set by Ion Science Ltd during instrument manufacture or on re-calibration. 'Custom Calibration' can be set by the instrument user.

For **Factory Calibration** contact Ion Science Ltd or your distributor.

'Factory Calibration' offers a safe set of three-point calibration data. This should be used if the custom calibration fails and will keep the unit working until a good custom calibration is completed.

For **Custom Calibration**, first set up the parameters in TIGER^{LT} PC - see the 'TIGER^{LT} PC Software' section of the manual.

TIGER^{LT} allows you to custom calibrate using any gas concentration from 10ppm. A cylinder of the selected gas at each of the chosen concentrations is required. Demand flow regulators are recommended for the TIGER^{LT}. If flow regulators are to be used then a 0.3L/min is recommended, a flow adaptor should be used to avoid over-pressurising the instrument (sold separately).

Have the cylinder(s) of gas, regulator(s) and the zero carbon filter (included in the Calibration Kit (A-861418) for your TIGER^{LT}) ready before starting the procedure. Alternatively a known clean air supply may be used as the 'zero' gas. Please ensure you are familiar with the entire calibration procedure before attempting to calibrate your TIGER^{LT}.

Note: The calibration of your TIGER^{LT} must be carried out in a clean air environment. Ensure all parts of the Calibration Kit are available and ready for use.

Never calibrate the zero with the span gas connected.

Press the **Options** soft key  on your TIGER^{LT} to access the adjustable features.



Then use the **Up** or **Down** key to select calibration.  Press **Enter** to confirm selection.

Select **Custom Calibration**  and press **Enter** to confirm.

On confirming the selection, the user is presented with a 30 second count down.

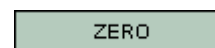

Remove both caps from the Carbon Filter Assembly (A-31057) and then fit onto the probe of your TIGER^{LT}. Press **Enter** to start the 'zero' countdown. At the end of the count down a tick '✓' will appear, indicating that the Zero has been accepted. Disconnect the Carbon Filter Assembly and replace the cap ends. The useful life of the Carbon Filter Assembly will be shortened if the Carbon Filter Assembly is open to atmosphere for prolonged periods.



Maintenance

Press **Enter** again and the gas and concentration for Span 1 (previously set up in TIGER PC^{LT}) are displayed along with a 30 second countdown. **SPAN 1** Attach the 'Span 1' gas using the Calibration Adaptor (861476) supplied in the Accessory Box (A-861267) (see 'Accessories') and press **Enter** to start the Span 1 countdown. At the end of the count down a tick '✓' will appear, indicating that the Span 1 has been accepted. For two-point calibration, press **Enter** and the calibration is complete.

Inlet Probe (Part number: 880207) from January 2016

The Tiger inlet probe design was updated for a stronger design to ensure a longer working life. The probes are supplied as standard on Tiger instruments supplied from January 2016. These probes can be used on older instruments however an alternative filter clamp and seal are required. An upgraded kit is available.

Probe upgrade kit: A-880214

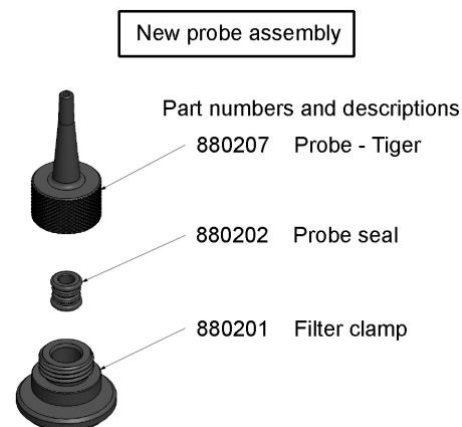

PTFE Filter Disc (861221)

The Filter Disc should be changed after every 100 hours of use. This interval should be shortened for dusty or moisture laden environments or whenever the filter appears 'dirty' Filter Disc changing should be conducted in a suitably clean environment, with clean hands and equipment to avoid contamination of the new Filter Disc.

To change the Filter Disc, unscrew the Filter Housing Cap, lift off the Filter Clamp and O-Ring and lift the Filter Disc from the Instrument Body. Carefully place a new Filter Disc into the Instrument Body. **Under no circumstances should a Filter Disc be used once it has been removed.** Replace the Filter Clamp, ensuring the locating lugs are correctly positioned in the cut-outs in the instrument body and that the O-Ring is correctly seated. Replace the Filter Housing Cap. Do not over-tighten.



Maintenance

PID Sensor/Lamp Replacement and Cleaning

When using your TIGER^{LT} in conditions of high ambient humidity, the PID may show unexpected readings appearing to increase. This occurs due to dust or other small particles within the detector becoming hydrated with humidity. This causes these particles to conduct a signal between the electrodes. The problem can be resolved by the user in the field using the procedure below and a can of computer duster air.

In normal use the lamp should be cleaned after every 100 hours of use (based on 30 ppm for 100 hours). Reduce this if TIGER^{LT} is used in heavily gas contaminated environments. Please note that some esters, amines and halogenated compounds may accelerate window fouling; in these cases cleaning may be required after every 20 hours of use. Cleaning frequency will also depend upon alarm levels set and prevailing environmental conditions.

CAUTION!

The TIGER^{LT} is a sensitive detector. Internal components must be handled with clean hands and clean tools. The TIGER^{LT} lamp is fragile. Handle with great care. Never touch the window and do not drop!!

To remove the MiniPID 2 Sensor for cleaning or lamp replacement, first ensure that the TIGER^{LT} is turned off and that you are in a clean environment such that the sensor parts will not be contaminated by dust, oil or grease. Remove the Sensor Cover (see image on right). The centre screw may be turned with a small coin or a suitable flat bladed screwdriver.

Ensure that the Sensor Seal, on the inside of the Sensor Cover is not disturbed.

Carefully lift the MiniPID 2 Sensor from the Instrument Body, ensuring that the two Inlet/Outlet Seals remain in place in the Instrument Body.

Using the special Mini PID electrode stack removal tool (846216) provided, locate its 'prongs' in the slots in the side of the MiniPID 2 Sensor body. Using the forefinger to restrain the sensor, (the internal parts are spring-loaded and careless disassembly will leave you hunting for the spring!) squeeze the tool to release the lamp housing.

The lamp may now be removed.

To replace the lamp or install a new one, reverse the procedure, ensuring the seals are all in place. When replacing the Sensor Cover ensure that the markers are aligned correctly and that the cover is a snug fit.

The instrument **MUST** be re-calibrated after fitting a replacement or cleaned lamp.

CAUTION!

Never refit a damaged lamp!





Maintenance

Lamp Cleaning

The TIGER^{LT} PID relies on an ultraviolet light source ionising VOC gases as they pass across the lamp window. This process may result in a very fine layer of contamination appearing on the detector window that must be removed on a regular basis.

CAUTION!

The TIGER^{LT} is a sensitive detector. Internal components must be handled with clean hands and clean tools. The TIGER^{LT} lamp is fragile. Handle with great care!

First ensure that the TIGER^{LT} is turned off and that you are in a clean environment such that the sensor parts will not be contaminated by dust, oil or grease.

Remove the lamp as detailed on page 34.

Inspection of the lamp may reveal a layer of contamination on the detection window that presents itself as a 'blue hue.' To check for confirmation, hold the lamp in front of a light source and look across the window surface. Clean the window using the PID Lamp Cleaning Kit (A-31063) supplied.

USE of PID Lamp Cleaning Kit A-31063

The container of cleaning compound contains Aluminium Oxide as a very fine powder (CAS Number 1344-28-1).

A full material safety data sheet MSDS is available on request from Ion Science Ltd. The key issues are listed below:

Always replace the lid after using the cleaning compound.

Hazard identification:

- May cause irritation of respiratory tract and eyes.

Handling:

- Do not breathe vapour/dust. Avoid contact with skin, eyes and clothing;
- Wear suitable protective clothing;
- Follow industrial hygiene practices: Wash face and hands thoroughly with soap and water after use and before eating, drinking, smoking or applying cosmetics;
- The Compound has a TVL(TWA) of 10 mg/m³.

Storage:

- Keep container closed to prevent water adsorption and contamination.

To clean the lamp:

1. Open the vial of Aluminium Oxide polishing compound. With a clean cotton bud collect a small amount of compound;
2. Use this cotton bud to polish the PID lamp window. Use a circular action applying light pressure to clean the lamp window. Never touch the lamp window with fingers;
3. Continue polishing until an audible "squeaking" is made by the cotton bud with compound moving over the window surface (usually within fifteen seconds);
4. Remove the residual powder with short blast of air from the can of air duster;
5. The instrument **MUST** now be re-calibrated.





Tiger^{LT} parts

Tiger main assembly



ITEM	DESCRIPTION	PART NUMBER	QTY
A1	Instrument body	A-8611274	1
A2	Rechargeable battery pack	A-861240	1
A3	AA battery pack	A-861241	1
A4	Charge cradle	A-861220	1
A5	Sensor cover	A-861259	1
A6	MiniPID 2 sensor	MP6SX66XU2	1
7	Sensor gasket	861203-9	1
8	Instrument boot	861205	1
9	Sensor seal	A-861214	1
10	Inlet / outlet seal	861215	2
11	Filter housing cap	861218	1
12	Filter clamp	861579	1
13	Filter disc	861221	1
14	Probe - Tiger	880207	1
15	O-ring	5/OV-02	1
16	Probe seal	880202	1



Accessories

Ion Science Ltd has developed an exclusive range of high quality accessories to compliment the TIGER^{LT}. Please see a selection of these below:

Part Number	Accessory Description
1/jawu-01	Car Charger Lead – Allows the Charger Cradle (A4) to be powered from a standard vehicle cigar lighter (12 volt only)
A-861214	Sensor Seal (9) – Seal between the MiniPID Sensor (A6) and the Sensor Cover (A5)
846216	Mini PID electrode stack removal tool – Used to remove Stack / Pellet from the MiniPID Sensor (A6)
861205	Protective, Removable Rubber Boot (8) – Supplied with every TIGER, this is a replacement
861219	Filter Clamp (12) – clamp that covers the PTFE filter and accepts the extension probe
861230	USB Cable – Supplied with every TIGER, this is a replacement
861266	Leather instrument holster – TIGER can be carried on a belt around the waist allowing hands free operation
861412	Leather instrument harness – TIGER can be carried against upper body allowing hands free operation
880207	Inlet probe – new stronger design. Standard from January 2016
880202	Probe seal (used with 880207 above) Standard from January 2016
861579	Filter clamp (used with 880207 above) Standard from January 2016
A-880210	Probe upgrade kit – Contains 880207, 880202 and 861579 (above)
861476	Calibration Adaptor – Must be used when calibrating using flow regulators
A-31057	Carbon Filter – Used during calibration to set a zero
A-31063	PID Lamp Cleaning Kit- Contains Alumina powder and 40 cotton buds
A-861413	5 m Extension Hose – Replaces the standard probe, pipe material: PTFE
A-861414	10 m Extension Hose – Replaces the standard probe, pipe material: PTFE
A-861415	Diluter – Dilutes immediate sample with ambient air
A-861406	Flexible Probe – 300mm, replaces the standard probe, internal pipe material: PTFE
A-861240	Lithium ion battery pack, intrinsically safe – Replacement / spare
A-861241	Alkaline battery pack, intrinsically safe. 3 x AA batteries included – Replacement / spare
A-861267	Accessory box as supplied with the TIGER – Includes carbon filter, lamp cleaning kit, PID Stack / Pellet removal tool, lanyard, calibration adaptor and PID sensor seal
A-861472	PTFE Filter Discs (pack of 10)
A-861511	Anti-vibration charger cradle – Allows wall mounting of vehicle charging, includes charge cradle
LA4TM600	Lamp 10.6eV
MP6SX66XU2	Replacement MiniPID (Orange stack)

For more information please visit www.ionscience.com/Tiger and select Accessories.



Instrument warranty and service

Warranty

Standard Warranty can be extended to up to 2 years on the TIGER^{LT} when registering your instrument via our website: www.ionscience.com/instrument-registration To receive your Extended Warranty, you need to register within one month of purchase (Terms and Conditions apply).

To register your TIGER instrument, simply fill in the online form. You will need to enter your instrument serial number to hand. The serial number is located on the front label of the instrument, towards the bottom end of the unit. Beneath the bar code, there will be a number beginning with T- followed by 6 digits. (E.g.T-123456).

You will then receive a confirmation email that your Extended Warranty Period has been activated and processed.

Full details, along with a copy of our Warranty Statement can be found by visiting:
www.ionscience.com/instrument-registration

Service

At Ion Science Ltd we recommend that all of our gas detection instruments be returned for service and factory calibration once every 12 months.

Contact Ion Science Ltd or your local distributor for service options in your area.

Find your local distributor by visiting: www.ionscience.com

Contact Details:

UK Head Office

Ion Science Ltd
The Hive, Butts lane,
Fowlmere
Cambridge
SG8 7SL
UK

Tel: +44 (0)1763 207206

Email: info@ionscience.com

Web: www.ionscience.com

US Corporate HQ

Ion Science Inc.
4153 Bluebonnet Drive, Stafford
Texas
77477
USA

Tel: +1 877 8647710

Email: info@ionscienceusa.com

Web: www.ionscience.com

German Office

Ion Science Messtechnik GMBH
Laubach 30
Metmann-Neandertal
40822
GERMANY

Tel: +49 2104 14480

Fax: +49 2104 144825

Email: info@ism-d.de

Web: www.ism-d.de

Italian Office

Ion Science Italia
Via Emilia 51/c
40011 Anzola Emilia
Bologna
ITALY

Tel: +39 051 0561850

Fax: +39 051 0561851

Email: info@ionscience.it

Web: www.ionscience.it



Technical specification

Response time:	T90 < 2 second	
Detectable		
Range:	0 ppm – 5,000 ppm	
Resolution:	0.1 ppm	
Accuracy:	+/- 5% displayed reading +/- one digit	
Linearity:	+/- 5% displayed reading +/- one digit	
Battery:	Lithium ion:	24 hours
	Alkaline (Duracell Procell MN1500):	8.5 hours
Data log:	Including date / time:	80,000
Alarm visual:	Flashing Red and Amber LED	
Alarm audible:	95 dBA @ 300 mm	
Flow Rate:	≥ 220 ml/min in Ambient conditions	
Temperature:	Operating:	-20 to 60 °C (-4 to 140 °F)
	Storage:	-25 to 60 °C (-13 to 140 °F)
	Certified to:	-15 to 45 °C (-5 to 140 °F)
Dimensions:	Instrument:	370.0mm / 14.56" (H) 91.4mm / 3.59" (W) 61mm / 2.40" (D)
Weight:	Instrument:	0.75 kg (1.6 lb)
Materials:	Instrument:	Anti-static PC/ABS (Polycarbonate/ Acrylonitrile Butadiene Styrene)
	Rubber Boot:	Anti-static TPE (Thermoplastic Polyolefin Elastomeric)



Manual log

Manual version	Amendment	Issue Date	Instrument Firmware	PC Software
V1.0	Manual created	16/06/15	V0.5.02	V1.1.0.2
V1.1	Reference to survey mode removed (page8) Part number descriptions updated (page37)	18/09/15	V0.5.09	V1.1.0.3
V1.2	New probe design. Pages 33, 36 and 37	27/01/2016	V0.5.09	V1.1.0.3
V1.3	Warranty length updated	18/02/2016	V0.5.09	V1.1.0.3
V1.4	Part number update on diagram - page 36 Declaration of Conformity – page 5 MiniPID to MiniPID2 throughout – throughout. US postal address page 39 Statement page 7 Minor text refinement throughout	13/06/2016	V0.5.09	V1.1.0.3
V1.5	Cover image updated - page 1 Display range - page 11 Zero statement - page 22 Cal times to 30 secs - Page 32 & 33 Part descriptions – page 34, 37 Updated exploded diagram - page 36 Dimension corrected - page 40 dBA distance to mm - page 40 Disclaimer added – page 41	30/11/2016	V0.5.09	V1.1.0.3

Disclaimer: Information in this [manual, document...] is subject to change without notice and does not represent a commitment on the part of Ion Science. No claims, promises or guarantees are made about the accuracy, completeness, or adequacy of the information contained herein.