



# Tiger Select

Instrument User Manual V3.0



**Distributed by:**

GasDetectorsUSA.com  
Houston, Texas USA  
sales@GasDetectorsUSA.com  
832-615-3588

Register  
your instrument  
online to receive  
your extended  
warranty.

Unrivalled Gas Detecti**ion**.

ionscience.com

## **Register your instrument online for extended warranty**

Thank you for purchasing your Ion Science instrument.

The standard warranty of your instrument can be extended to up to five years on Tiger and two years on other Ion Science instruments.

To receive your extended warranty, you must register your instrument online within one month of purchase (terms and conditions apply.)

Visit [www.ionscience.com/instrument-registration](http://www.ionscience.com/instrument-registration)



## Contents

---

<b>Statements</b> .....	<b>5</b>
Responsibility for Use .....	5
IMPORTANT .....	5
Quality Assurance .....	5
Disposal .....	5
Calibration Facility .....	5
Legal Notice .....	5
<b>Introduction</b> .....	<b>6</b>
<b>Lamp output</b> .....	<b>7</b>
<b>Filter tubes</b> .....	<b>7</b>
Safety Advice – Tube disposal .....	7
<b>Getting started</b> .....	<b>8</b>
The Manual .....	8
Inlet Nozzles .....	8
Turn On .....	8
Turn Off .....	8
Batteries .....	8
Rechargeable Batteries .....	8
Alkaline Batteries .....	8
Select the Gas .....	8
Set Alarm Levels .....	8
TIGER PC .....	8
<b>Understanding the keypad</b> .....	<b>9</b>
General Description .....	9
Keypad Function Descriptions .....	9
<b>Understanding the display screen</b> .....	<b>10</b>
Screen Display .....	10
Status icon .....	10
<b>Understanding the display screen</b> .....	<b>11</b>
Backlight .....	11
Sound .....	11
Alarm Bell .....	11
Flashlight / Torch .....	11
Lock .....	11
<b>Main Screen Area</b> .....	11
<b>Start up</b> .....	<b>11</b>
<b>Basic Mode start up</b> .....	<b>11</b>
Button A: .....	12
Tube mode .....	12
Button B: .....	12
<b>Advanced mode start up</b> .....	<b>13</b>
Button A: .....	13
Tube mode .....	13
Button B .....	13
Calibration .....	13
<b>TAC</b> .....	<b>13</b>
Data Logging .....	14
Gas selection .....	14
Average .....	14
Peak Hold .....	14
Zones .....	14
Health & Safety* .....	15
Options .....	15
Alarms .....	16
Info screen icons .....	16
<b>Calibration</b> .....	<b>18</b>
Tube Calibration (Basic and Advanced mode) .....	18
Frequency of calibration .....	18
Demand and flow regulators .....	18
Tube calibration routine .....	19



Procedure .....	19
Preparing the pre-filter tube .....	20
Fitting the pre-filter tube .....	20
PID custom calibration routine .....	21
<b>TAC mode routine .....</b>	<b>22</b>
<b>Select / Tube mode routine .....</b>	<b>23</b>
Tube Mode measurement routine .....	23
Advanced: Tube Mode .....	23
H&S function (STEL calculation) .....	23
Tube Mode Procedure .....	24
<b>Tiger PC software .....</b>	<b>25</b>
PC Requirements .....	25
Installation of TIGER PC Software .....	25
Connecting TIGER to a PC .....	26
Backlight .....	29
Sound .....	29
Units .....	29
Lock .....	29
Sleep .....	29
Zeroing .....	30
Zero at switch on .....	30
Fixed zero .....	30
Zero tracking .....	30
Clock .....	30
Lamp .....	30
Soft Menu .....	30
Data log .....	30
Log Full .....	31
Zones .....	31
Vibrate .....	31
TWA STEL .....	31
Calibration .....	31
Startup Text .....	31
The Gas Table Screen (including setting alarm levels) .....	32
The Firmware Screen .....	33
Downloading Data Logged Readings .....	35
The Health Safety Screen .....	36
The Snapshots Screen .....	36
Software Disclaimers .....	37
<b>Batteries .....</b>	<b>38</b>
Recharging Batteries .....	38
Replacement / Exchange of Battery Packs .....	39
Replacement of Non-rechargeable Batteries in Battery Pack .....	40
<b>Diagnostics .....</b>	<b>41</b>
Maintenance .....	42
Inlet Probe assembly .....	42
PTFE Filter Disc .....	42
PID Sensor/Lamp Replacement and Cleaning .....	43
Lamp Cleaning .....	44
PID sensor access and batteries .....	45
<b>Parts list .....</b>	<b>46</b>
<b>Instrument warranty and service .....</b>	<b>46</b>
<b>Warranty</b> .....	46
<b>Service</b> .....	46
<b>Contact details .....</b>	<b>47</b>
<b>Technical specification .....</b>	<b>48</b>
<b>Manual log .....</b>	<b>49</b>



## Statements

---

### Responsibility for Use

TIGER Select instruments detect a large range of gases which are potentially dangerous from both a poisoning and/or an explosive perspective. TIGER Select instruments have many adjustable and selectable features allowing the detector to be used in a variety of ways. Ion Science Ltd can accept no responsibility for the incorrect adjustment of features that cause harm or damage to persons or property. TIGER Select can be used as a personal safety device. It is the user's responsibility to respond appropriately to an alarm situation.

Inadequate performance of the gas detection equipment described in this manual may not necessarily be self-evident and consequently equipment must be regularly inspected and maintained. Ion Science Ltd recommends that personnel responsible for equipment use a regime of regular checks prior to use to ensure it performs within calibration limits, and that a record be maintained which logs calibration check data. The equipment should be used in accordance with this manual, and in compliance with local safety standards.

### IMPORTANT

It is essential that the TIGER Select is always used with a supplied 0.5 micron PTFE Filter Disc fitted to the front of the instrument. Without a filter, particles of debris and dust can be drawn into the detector inhibiting the function of the instrument. These filters are consumable and should be changed after every 100 hours of use. The frequency of replacement should be increased for dusty or moisture laden environments. Filters are available from your distributor or at [www.ionscience.com](http://www.ionscience.com).

### Quality Assurance

TIGER Select has been manufactured in compliance with ISO9001:2008, which ensures that the equipment supplied to our customers has been designed and assembled reproducibly, from traceable components, and leaves Ion Science Ltd calibrated to stated standards.

### Disposal

Dispose of TIGER Select, its components and any used batteries in accordance with all local and national safety and environmental requirements. This includes the European WEEE (Waste Electrical and Electronic Equipment) directive. Ion Science Ltd offers a take back service. Please contact us for more information. The TIGER Select field case material is recyclable polypropylene.

### Calibration Facility

Ion Science Ltd offers a calibration service including the issue of certification confirming calibration with equipment traceable to national standards. A TIGER Select calibration kit is available from your distributor or service centre or at [www.ionscience.com](http://www.ionscience.com). Ion Science Ltd recommends annual return of all instruments for yearly service and calibration.

### Legal Notice

Whilst every attempt is made to ensure the accuracy of the information contained in this manual, Ion Science Ltd accepts no liability for errors or omissions, or any consequences deriving from the use of information contained herein. It is provided "as is" and without any representation, term, condition or warranty of any kind, either express or implied. To the extent permitted by law, Ion Science Ltd shall not be liable to any person or entity for any loss or damage which may arise from the use of this manual. We reserve the right at any time and without any notice to remove, amend or vary any of the content which appears herein.



## Introduction

Benzene gas is a carcinogen often associated with petrochemical processing but it is also used as a solvent in the production of drugs, plastics, synthetic rubbers and dyes. Photo ionization detectors (PID) readily detect a wide range of VOC gases of which includes benzene.

Gases that are cross sensitive to benzene will result in significant errors in reading which are unacceptable when occupational exposure levels are set around 1ppm.

The Tiger Select has been developed to give an accurate and repeatable measurement of benzene gas specifically to sub ppm levels.

The Tiger Select has two methods of operation; standard TAC operation which identifies the presence of Total Aromatic Compounds (which include benzene), and Tube operation which then identifies the specific benzene content. This two stage approach avoids using filter tube unnecessarily; if there are no TAC gases present there is also no benzene.

The Tiger Select uses a 10.0 eV light source so many of the gases associated with benzene are ignored.

The remaining gases associated with benzene are removed within a benzene pre-filter tube.

Note: n-butane, n-pentane, ethylene, propylene, ethanol and ethyl acetate are not shown on this illustration, however they are also beyond the detection range of the 10.0 eV lamp so are not detected.

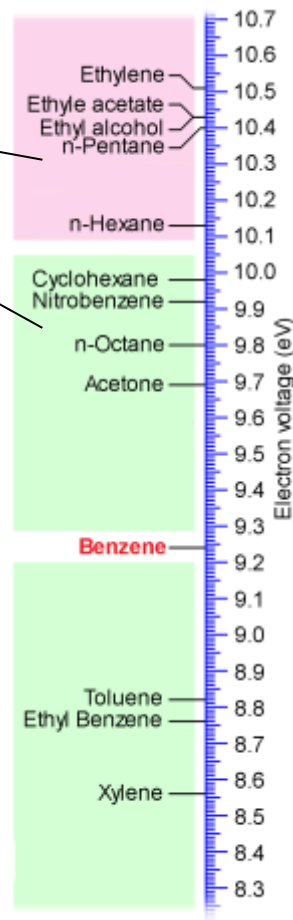



## Lamp output

The number of gases a PID can detectable directly relates to the maximum photon energy (units eV) of the PID lamp being used. The higher the photon energy the more gases can be detected

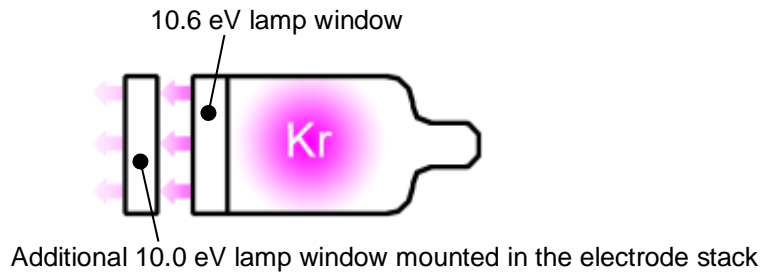

### Important

Always recalibrate the Tiger Select after servicing, particularly if the lamp or electrode stack is cleaned or replaced.

## Filter tubes

Benzene Pre filter tubes absorb many VOC gases however the benzene content passes through. The gas sample must be drawn through the tube to condition it before the absorption level becomes stable. Please see the leaflet supplied with the pack of tubes for maximum absorption levels.

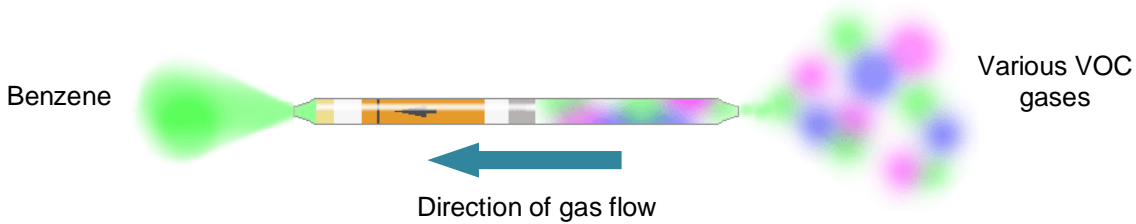

### Important

During the benzene measurement, the Yellow/Orange indicating layer turns brown or green in the presence of other aromatic hydrocarbons and/or benzene hydrocarbons. If this colouring is longer than the 3/4 marking, the filter capacity of the tube is not sufficient anymore and the benzene display may not be accurate.

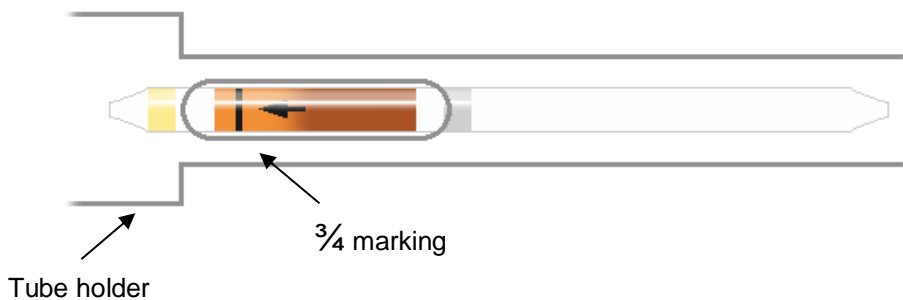

### Safety Advice – Tube disposal

Dispose of tubes according to local regulations. Do not draw humid air for extended periods, or any liquid water, through the tubes as corrosive liquids could be created which will damage the instrument. “



## Getting started

---

Thank you for choosing TIGER Select from Ion Science Ltd. We hope that your Tiger Select will give you many years of active and trouble-free service.

### The Manual

This manual describes the function and operation of the TIGER Select instrument. Ion Science Ltd recommend that you familiarise yourself with this manual before using your Tiger Select. The 'Statements' and 'Introduction to Tiger Select' sections contain important information, which should be read before you turn your Tiger Select on for the first time.

### Inlet Nozzles

Ensure that the inlet nozzle supplied is fitted to your Tiger Select. Details on how to fit and change inlet nozzles is detailed in the 'Maintenance' section. If the supplied inlet nozzle is unsuitable for your application, details of alternative inlet nozzles can be found in the 'Maintenance' section as well.

### Turn On

Press the **Enter / On/Off** key once to turn Tiger Select on.



### Turn Off

Press and hold the **Enter / On/Off** key for 3 seconds, indicated by a 3 second countdown, to turn Tiger Select off. (**Note:** If the Tiger Select fails to shut down, press the **Escape (Esc)** key once or twice to return to the main screen, then press and hold the **Enter / On/Off** key again.)



### Batteries

Check that your Tiger Select has sufficient charge for use. The battery icon (see 'Understanding the display screen') should show at least two full segments.

### Rechargeable Batteries

Tiger Select instruments leave the factory with the Rechargeable Battery Pack (A2) fully charged. However prolonged periods of storage may result in the battery pack discharging. We recommend charging the instrument for seven hours before use. See the 'Batteries' section of this manual.

### Alkaline Batteries

An alkaline AA battery pack (A3) can also be used with the Tiger Select. For more information please see the 'Batteries' section of this manual.

### Select the Gas

Tiger Select instruments leave Ion Science Ltd pre-set for gas type TAC. Instruments are factory calibrated against isobutylene and all response factors are equivalent to this. By changing the gas from the internal gas table all readings will be given using that gas response factor.

Switch the Tiger Select on by pressing the Enter / On/Off key once.

Press the **Information** icon  (see 'Using your Tiger Select') and check the correct gas alarms are selected.

Change the gas (if necessary) as instructed under Gas Selection in the 'Using your Tiger Select' section.

### Set Alarm Levels

We recommend that alarm levels are set to user specifications as soon as possible before the Tiger Select is used for the first time. Please see the 'Using your Tiger Select' section of the manual for details of how to set alarm levels.

**TIGER PC.** The full functionality of your Tiger Select can only be realised through the TIGER PC software. Ion Science Ltd recommend that you load the software supplied with your instrument and set up your Tiger Select according to the instructions in the 'TIGER PC Software' section of this manual.





## Understanding the keypad

---

### General Description

The keypad comprises two soft keys (**A** and **B**), **Up** and **Down** arrow keys, an **Escape (Esc)** key, and an **Enter / On/Off** button.

In general, setup and application settings are selected and adjusted via the soft keys. Options are selected by the arrow keys and confirmed by the **Enter** key, or relevant soft key.

A single press is used as a switching operation. A continuous press is used to adjust numbers or change gas selections by automatically rolling.

### Keypad Function Descriptions



Soft keys **A** and **B** rely on graphical prompts on the display to indicate their functionality.



**Up** and **Down** keys are used to adjust settings and navigate through the menu structure.



**Enter / On/Off** key is used to accept adjustments and select functions; also to turn the TIGER on and off.



**Escape (Esc)** key is used to abort an adjustment or exit from a menu.





## Understanding the display screen

### Screen Display

The display is divided into four sections:

Fixed LCD Status icons fill the top of the screen offering instrument status at a glance. The icons display only when a function is selected.

The main central viewing screen will display readings in large numbers only. The Tiger instrument auto-ranges therefore the number of decimal places reduce as the VOC reading increases. The minimum achievable sensitivity is 0.001 ppm, the maximum range is 19,999 ppm.

Two soft key areas have been set aside as soft key indicators.

The area between the soft key indicators displays the measurement units.



Left is the default display with no functions active.



Right is the display with all functions active.

### Status icon



**Health and Safety** (optional): The icon consists of a single part and will flash in an alarm condition and when health and safety readings are being collected.



**Peak Hold:** When peak hold is switched on, the icon appears.



**Memory Status:** This icon only appears if the instrument has the data logging functionality. Four sections within the border fill as the data log memory is filled. Empty border = 100% memory available through to full, where all segments are present. The memory icon will flash whilst multi-logging is activated.

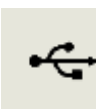

**USB:** The icon will appear when connected to a host device.



**Battery Status:** This icon consists of a border and four segments. The segments fill or empty to available capacity. When discharging, the border of the final segment will flash for one minute before the instrument shuts down. When charging, the segments will successively fill until all four segments are highlighted, indicating full charging.





## Understanding the display screen

---



**Backlight:** Light beam lines appear when the backlight is on.



**Sound:** The main body of the icon is present at all times. The disable lines appear if all three alarm sounders are disabled and the volume is at 0%. Three sound projection lines indicate the volume level. There are four sound levels and the quietest level has no line.



**Alarm Bell:** The icon consists of two parts, the Bell and the sound bars. When the instrument reaches a 'Low alarm' the Bell and one sound bar will flash; when a 'High alarm' is reached the Bell and both sound bars flash.



**Flashlight / Torch:** Pressing both soft keys together switches the flashlight / torch on and off. When the flashlight / torch is illuminated the light beams appear.



**Lock:** The Lock icon will appear when the configuration of the TIGER has been locked in TIGER PC. Soft keys in Button **A** column are enabled and Buttons in column **B** disabled, see page 13.

### Main Screen Area

During normal operation this area displays the readings in four large numbers, with the units of measurement below.

During setup and adjustment, a function bar overlays the main screen.

## Start up

---

### Using your Tiger Select

When the Select is first switched on, the instrument will start up in Basic mode as default. However, it is possible to set the unit to always switch on in Advanced mode, or to "Ask" the user during the initial switch on routine; this is configurable via Tiger PC.

If required, the Select can be upgraded with additional features: PPB sensitivity, Health & Safety, Data logging options: Single-log, Multi-log.

### Basic Mode start up

---

Basic mode has been designed to incorporate the core functions for total aromatic compound (TAC) detection, for greatest efficiency and ease of use when using the Tiger Select.

The default settings for Selects in this mode are as follows:

- 10.0eV lamp
- TAC gas
- PPM
- Backlight adjusts according to ambient light

The user can change various Basic mode settings via Tiger PC, including the following: gas, backlight, sound, vibrate, units, sleep during PC connect, zeroing, zones, and data log sampling (if enabled).

In this mode, the display shows a live reading of gas concentration. As standard, this mode will operate using 0.01 ppm sensitivity for TAC and 0.1 ppm sensitivity for all other selectable compounds, unless ppb sensitivity has been activated. If data logging has been purchased, the user will need to set up the preferred settings via the configuration screen of Tiger PC. Please refer to the Tiger PC software section of this manual for further details.



The Basic mode display offers two functions; Tube mode, and Calibration.

**Button A:**  
**Tube mode**



Tube mode is designed to identify the level of benzene gas present after a significant background has been identified. The Tube mode allows users to measure an accurate level of benzene using the benzene pre-filter tube. The initial benzene test has a test time which varies with temperature. This test time is required to condition the tube which thereafter offer a proportional output relating to the benzene being sampled.

**Please refer to the 'Basic: Tube Mode' section of this manual for details of the Tube Mode procedure.**

The Tube mode results will be automatically logged, which can later be reviewed in the Health & Safety screen via Tiger PC.

**Please note:** A tube calibration must be carried out before Tube mode can be used. The following icon will



appear until a Tube calibration is carried out:

To carry out a tube calibration please refer to the calibration section of this manual.

**IMPORTANT:** When entering Tube mode the pump will stop until the test cycle begins. This is not a fault condition. The initial gas sample from the tube is used to set the zero, therefore, it is essential that a clean tube is used.

**Button B:**



**Calibration**



When selected, the user is presented with two options:

**1. TUBE calibration:**

A tube calibration is required before Tube mode can be used and should be carried out as part of regular maintenance, as well as when a new batch of tubes are used. Batch numbers can be located on the tube box packaging.

**2. PID calibration:**



*Factory:* Users can set their instruments to operate using the factory calibrated values, however, the actual calibration function cannot be carried out by the user. The instrument must be returned to Ion Science Ltd or an authorised service centre.



*Custom:* Users can carry out a custom calibration with the 10.0eV mini PID. Custom PID calibration should be carried out as part of regular instrument maintenance.

**ZERO** Zero: option allows the user to either set the instrument to the selected calibration zero (Absolute Mode), or to zero against the ambient (Relative mode).



When selected 'Absolute mode' uses fixed calibration zero (either Factory or Custom calibration).



When selected, 'Relative mode' sets the zero level to the ambient. Please refer to the calibration section of this manual for full details on calibration procedures.



## Advanced mode start up

---

### Button A:



### Tube mode

Tube mode is designed to identify the level of benzene gas present after a significant background has been identified. The Tube mode allows users to measure an accurate level of benzene using the benzene pre-filter tube. The initial benzene test has a test time which varies with temperature. This test time is required to condition the tube which thereafter offer a proportional output relating to the benzene being sampled.

**Please refer to the 'Advanced: Tube Mode' section of this manual for details of the Tube Mode procedure.**

The Tube mode results will be automatically logged, which can later be reviewed in the in Tiger PC.

**Please note:** A tube calibration must be carried out before Tube mode can be used. The following icon will appear until a Tube calibration is carried out:



To carry out a tube calibration please refer to the calibration section of this manual.

**IMPORTANT:** When entering Tube mode the pump will stop until the test cycle begins. This is not a fault condition. The initial gas sample from the tube is used to set the zero, therefore, it is essential that a clean tube is used.

### Button B:



In Advanced mode, the B button can be configured with multiple functions which can be accessed by using the Up and Down keys to scroll through the list. The available list can be configured via the Configuration screen of the Tiger PC software. As default, Button B will display the calibration icon, as shown in Basic mode.

### Calibration



Selecting the calibration icon presents the user with two options:

- 1. TUBE calibration:** A tube calibration is required before Tube mode can be used and should be carried out as part of regular maintenance, as well as when a new batch of tubes are used. Batch numbers can be located on the tube box packaging.
- 2. PID calibration:**



*Factory:* Users can set their instruments to operate using the factory calibrated values, however, the actual calibration function cannot be carried out by the user. The instrument must be returned to Ion Science Ltd or an authorised service centre.



*Custom:* Users can carry out a custom calibration with the 10.0eV mini PID. Custom PID calibration should be carried out as part of regular instrument maintenance.

Please refer to the calibration section of this manual for full details on calibration procedures.

### TAC



TAC mode automatically offers higher sensitivity and selects a response factor. Higher sensitivity down to 0.01 ppm benzene (RF 0.5) is automatically selected; no other gases are selectable when used in this mode.

The Tiger Select can be left in this mode even through a power cycle or battery replacement.

TAC mode can be entered and exited by selecting the TAC icon and then pressing the 'Enter' key.



### **IMPORTANT**

The TAC gas used within TAC mode has a STEL set to 1 ppm. This level has been chosen based on the low STEL levels often associated with aromatic chemicals, including benzene. The Tiger Select TAC STEL, however, is not supported by nationally recognised bodies who publish official levels.

#### **Data Logging**

##### **Single-log (push-to-log)\***

Press the **Single Data Log** soft key to take a single data log reading. The single data log symbol appears briefly with a tick:  before returning to the main screen. Press the **Single Data Log** soft key again to take another reading. The fixed LCD memory icon flashes off when a single log is taken.

##### **Multi-logging\***

Pressing the **Multi Data Log** soft key results in the multiple log symbol appearing with a question mark:



Press the **Enter** key to start the data logging process based on TIGER PC setup. A tick briefly appears beside the question mark to confirm that data logging has started, before then returning to the main running screen. The fixed LCD memory icon flashes once per second while continuous data logging is in progress. To stop data logging, press the soft key again. A crossed out data log symbol is presented with a question mark. Press the **Enter** key to confirm the action. A tick appears beside the question mark, confirming that data logging has stopped and the LCD memory icon ceases to flash, before returning to the main screen.

##### **Zeroing**

Pressing the **Zero** soft key presents two zero options  selected with the **Up** or **Down** keys. **The upper symbol represents an absolute zero. The lower symbol represents a relative zero which follows the drift of the PID detector.** Having made your selection, the screen will show a 'tick' to confirm your selection. If the relative zero has been selected TIGER Select will zero itself before returning to the main screen.

##### **Gas selection**

Press the **Gas Selection** soft key to display an alphabetical letter which can be changed using the **Up** and

**Down** keys:  Press the **Enter** key to present the gases beginning with that letter. Using the **Up** and **Down** keys scroll through the gases starting with that letter to find the subject gas. Press **Enter** to select the chosen gas. If a tick appears, press **Enter** again and TIGER Select will use the relevant data for the chosen gas from the gas table for alarms and response factor etc. Should the selected gas have no

numeric response factor then a warning screen  will appear. The message can be cleared by pressing the **Enter** key and the gas will still be selected.

##### **Average**

Press the **Average** soft key to display a rolling average over 10 seconds. A tick appears when time is up. Pressing the **Reset** soft key again resets the calculation even if there is an average already running. Press **Esc** to return to the main screen. To reset the peak value, press reset.

##### **Peak Hold**

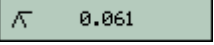

Press the **Peak Hold** soft key to present the screen  When Peak Hold is selected the sub display will appear and this will continue to display the peak reading until peak hold is no longer required. To deselect the peak hold function press **Esc**.

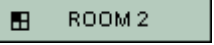
##### **Zones**

Press the **Zone** soft key to display the currently selected Zone:  The Tiger Selects default is 'Zone 1'. Zones are set up in Tiger PC only and the name given to the zone(s) will appear on the screen. Use the **Up** and **Down** keys to select alternative zones.



### Health & Safety\*

Press the **Health and Safety (H&S)** soft key to display the H&S symbol with a question mark to ask if the user wishes to proceed: . Press **Enter** to start the calculation. The STEL (Short Term Exposure Level) and TWA (Time Weighted Average) values are shown. The fixed LCD H&S icon will continually flash while calculating. Pressing the **Enter** key while the values are displayed presents the user with a screen asking if the calculation should stop. Press **Enter** again to stop the calculation. Press **Esc** to return to the main screen. If a gas has no STEL and TWA level allocated in the gas table the following symbol will appear: .

### Stealth mode

When selected, all audible and visual alarms are disabled except for the alarm indicator on the screen. This function may help avoid triggering panic in public places.

### Sleep mode

Press and hold the **Zzz** soft key to send the TIGER to sleep. A three second count down takes place before entering sleep mode. All functionality is switched off. Only Zzz remains on the screen. Press the **Esc** key to awaken the instrument.

The instrument can also enter 'Sleep mode' during data logging when the duration between logs exceeds two minutes. This is a power saving function which only occurs when a tick box is set in TIGER PC.)

### Options

Press the **Options** soft key to give access to various adjustable features, selected with the **Up** and **Down** keys. Press **Enter** to confirm selection.

### Backlight



Four options are presented: Permanently Off, Permanently On, On in low ambient light and Timed (Set the time in TIGER PC). Select the preferred option with the **Up** and **Down** keys and confirm with **Enter**.

### Sound

The sound options are presented as set up in TIGER PC. Use the **Down** key to select either keypad beep, alarm sound, crescendo or percentage volume. Press **Enter** to turn selection on or off. For percentage volume, press **Enter** again to confirm selection. The frame will flash. Use **Up** and **Down** keys to change the percentage volume and press **Enter** to confirm the chosen value. Press **Esc** twice to return to the main screen.



**Alarms** 

Upper  and Lower  alarm settings are displayed. Select the subject alarm using the **Up** and **Down** keys and press **Enter**. The arrow(s) on the chosen alarm will flash. Adjust the level using the **Up** and **Down** keys and press **Enter**. Repeat, if necessary for the other alarm. Press **Esc** twice to return to the main screen.











**Note:** The lower alarm setting must never be greater than the upper alarm.

**Units** 

Select the available units by using the **Up** and **Down** keys and then press **Enter**.

**Info screen icons**

Pressing the **Information** soft key allows access to a number of other information screens. Use the **Down** key to scroll through the screens. Press **Esc** to return to the main screen:

<b>First Screen</b>	Gas selected	
	Response Factor	RF
	Upper alarm	
	Lower alarm	
<b>Second screen</b>	Lamp selected	
	Date of Factory calibration	
	Date of Custom calibration	
	Date of Select tube calibration (optional)	
<b>Third Screen</b>	SPAN 1	 SPAN 1 (gas concentration set in TIGER PC)
	SPAN 2	 SPAN 2 (gas concentration set in TIGER PC)
	PID live response (in selected units)	PID
	PID sensor A/D reading	A/D
<b>Fourth Screen</b>	Short Term Exposure Levels (optional)	STEL
	Time Weighted Average (Optional)	TWA
	Internal Reference Number	IRN:
	Firmware version	Firmware:
	Bootloader version	Bootloader:
	Battery type and voltage	
<b>Fifth Screen</b>	Memory available	





	Gas Table Date	
	Run time	Run Time: 0:00
	Date and time	
<b>Sixth Screen</b>	Features*. An icon will appear for each feature available	Features ppb

\* These functions are optional and can be purchased either during initial sale, or via remote upgrade post-sale. For further information on upgrading your Tiger Select, please contact [info@ionscience.com](mailto:info@ionscience.com) or your local distributor.



## Calibration

### Tube Calibration (Basic and Advanced mode)

The Tiger Select has a separate calibration set aside for tube mode. Please note that a tube calibration must be carried out before access to tube mode is allowed. The Tube / Select calibration settings can be adjusted on the configuration screen in Tiger PC or directly via the instrument. Benzene gas must be selected when using a benzene pre filter however the calibration gas concentration can be adjusted.

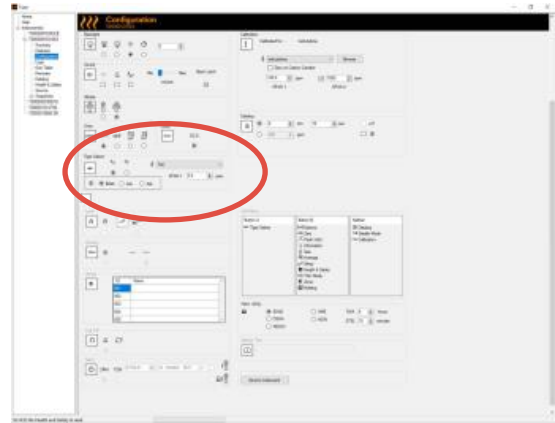

### Frequency of calibration

The frequency at which the Tiger Select is calibrated can vary considerably. Changes in environmental conditions, frequency of use or the gas being detected can all affect the accuracy of the instrument. Ion Science suggests customers carry out weekly calibrations but then extend this time as confidence is gained and any environmental effects identified.

Tiger Select should also be calibrated for the following reasons:-

- \* When a new batch of pre-filter tubes are used. Batch numbers can be found on the end of the tube carton.
- \* After servicing



### Demand and flow regulators

The Tiger Select can be calibrated using either a flow regulator or a demand regulator.

Demand regulators rely on the instrument pump drawing the sample from the gas bottle. These regulators supply exactly the amount of gas necessary to calibrate so are economical. They also avoid the risk of leaving the gas bottle switched on. However, demand regulators rely on the host instrument's pump to draw the sample which causes a slight partial vacuum of between -7 and -10 mbar. For an accurate calibration the entire pneumatic system must be completely sealed.

Flow regulators supply a fixed amount of gas which should exceed what the instrument requires. A little gas is lost and the instrument takes what it needs. The Tiger Select requires 250 cc/min so flow regulators of 300 mL/min (0.3 L/min) is advised. Being a flood leak the sample has the benefit of being matched to ambient air pressure.

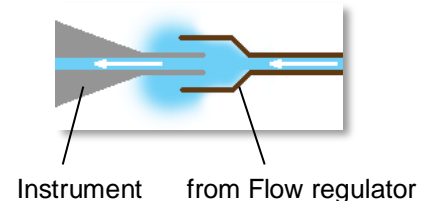



### Tube calibration routine

For best results, prior to completing instrument calibration we would recommend placing the Tiger Select and any benzene pre-filter tubes in the calibration environment. Switch the Tiger Select on and leave it running in the calibration environment for 30 minutes. This process ensures that the Tiger Select and tubes acclimatize to the environment, and ensures any trace benzene is purged from the instrument after previous testing.

The Tiger Select relies on a two point calibration to create its calibration factor. Both Zero and Span are set with one single stage. The Zero is set using the initial sample of clean air passing through a pre-filter tube, with the Span being set later.

**Important note:** The accuracy of the calibration is affected by ambient temperature, therefore, this must be entered correctly during the calibration procedure.

#### Procedure:

From the main running screen, select the CAL icon on Button B.

Highlight the TUBE option and press OK.

Select your chosen tube type and press OK.

Use the up and down arrows to adjust the displayed temperature to match your ambient temperature, then select NEXT. Use a separate temperature measuring device if necessary.

- Note:** At this point the pump will stop running. The display will prompt the user to insert a new tube. The tube will need to be prepared prior to fitting into the unit. Remove both ends of the pre filter tube using the tube opener tool. This is done by inserting the tube in to the tube opener and twisting the tube. A slight angle may be required to cut the glass (*please refer to image below*).
- Note:** If the tube breaks up to the shoulder it must not be used as this will damage the seals within tube holder when inserted. Unscrew the cap of the tube holder, and insert the tube in to the tube holder cap ensuring the black arrow on the tube is pointing towards the instrument. Screw the tube holder cap and the tube on to the instrument. Once fitted, press Next.
- Note:** If using a flow regulator, remove the grub screw from the end of the tube holder cap before starting the calibration to allow excess gas to escape (*please refer to image below*). Adjust the displayed concentration to reflect the calibration gas concentration being used, then connect the calibration gas to the tube holder probe and select OK.
- Note:** If using a flow regulator, remove the grub screw from the end of the tube holder cap before starting the calibration routine, to allow excess gas to escape. Ensure to switch the gas on before starting the calibration countdown, and turn the gas off once the cycle has completed.



**Warning:** Failure to allow excess pressure to escape could damage the Tiger Select pump.

The display will now countdown to zero whilst it completes the calibration routine. Once the countdown has completed, the Select will display a live reading of benzene. Press OK to accept the calibration and proceed. The display will prompt you to remove the used tube, then press OK to return to the main running screen.



### Preparing the pre-filter tube:



### Fitting the pre-filter tube:

- a. Unscrew the tube holder from the Tiger Select filter clamp
- b. Insert the prepared tube with the arrow pointing towards the instrument ensuring the orange section is visible through the slot in the tube holder.
- c. Carefully screw the tube holder onto the filter clamp



**IMPORTANT:** For best results, the pipe between the calibration cylinder and instrument should be as short as practically possible.  
A tube calibration error will occur at the end of the Tube calibration procedure if no gas has been presented.



### PID custom calibration routine

Prior to carrying out custom calibration, the calibration parameters can be configured. TIGER Select allows you to custom calibrate using any gas from the Gas Table at a concentration from 10ppm. You will need a cylinder of the selected gas at each of the chosen concentrations. Each cylinder should be regulated for a flow rate above 250ml/min.

Have the cylinder(s) of gas, regulator(s) and the zero carbon filter (included in the Calibration Kit (A-845213) for your TIGER Select) ready before starting the procedure. Demand flow regulators are recommended for the calibration of the Tiger. If flow regulators are to be used then a 0.3L/min is recommended, a flow adaptor should be used to avoid over-pressurising the instrument (sold separately). Alternatively a known clean air supply may be used as the 'zero' gas. Please ensure you are familiar with the entire calibration procedure before attempting to calibrate your TIGER Select.

**Note:** The calibration of your TIGER Select must be carried out in a clean air environment. Ensure all parts of the Calibration Kit are available and ready for use.

Never calibrate the zero with the span gas connected.

Procedure:

1. From the main running screen, select the CAL icon on Button B.
2. Highlight the PID option and press OK.
3. Select the custom calibration icon
4. Zero: Attach the carbon filter (if using) and select 'OK' to commence zero sequence. The display will countdown 30 seconds. Once complete, select 'OK' to proceed.
5. Span 1: adjust the concentration to the gas concentration being applied using the Up and Down arrow keys, if required. Present the gas to the instrument probe and select 'OK' to proceed. The display will countdown 30 seconds.
6. A tick will appear to confirm the span 1 calibration has been completed. Select 'OK' to proceed.
7. Span 2: if the unit has been configured for a two span calibration, the span 2 concentration will appear. Adjust the concentration to the gas concentration being applied using the Up and Down arrow keys, if required. Present the gas to the instrument probe and select 'OK' to proceed. The display will countdown 30 seconds.
8. A tick will appear to confirm the span 2 calibration has been completed. Select 'OK' to accept the calibration and return to the main screen / main calibration screen.



## TAC mode routine

The TAC soft key is used to ENTER and EXIT from TAC mode.

1. To select TAC mode press the TAC soft key then press then press the ENTER key to continue.
2. A tick / check '✓' will appear to confirm the selection
3. Press the Esc key to clear the confirmation
4. The TAC response factor will be displayed temporarily before entering TAC mode operation.
5. TAC mode automatically selects a specific instrument setup, to ensure best results. The TAC response factor and higher sensitivity functions become available.
6. To exit TAC mode Press the TAC soft key and then ENTER.
7. A tick / check '✓' will appear to confirm the selection, then press the Esc key.
8. The gas response factor will be displayed temporarily before exiting TAC mode.

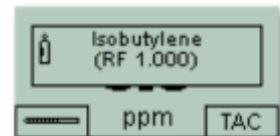
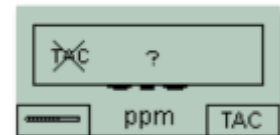
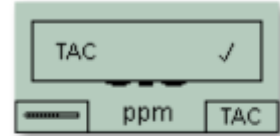
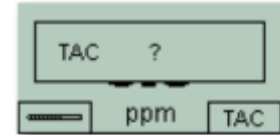



## Select / Tube mode routine

### Tube Mode measurement routine

#### Basic: Tube Mode

The Basic Tube Mode consists of a single point benzene reading only. The initial benzene test has a test time which varies with temperature. This test time is required to condition the tube which thereafter offer a proportional output relating to the benzene being sampled.

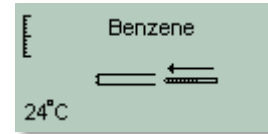

#### Tube Mode Procedure:

- To enter tube mode, select "TUBE" using the soft-key button A. At this point, the pump will stop running and the calibration-selected tube type will briefly appear, before displaying the temperature screen.  
Adjust the on-screen temperature to reflect the ambient temperature, using the Up and Down arrow keys. The default temperature units are set to °C, however, preferred temperature units (°C or °F) are set in the Configuration screen of Tiger PC. Select "NEXT".  
The display will indicate for the new tube to be inserted. Remove both ends of the pre-filter tube using the tube opener tool by inserting the tube into the tube opener and twisting the tube. A slight angle may be required to cut the glass.  
**Note:** Should the tube break up to the shoulder, it must not be used as this will damage the seals within the tube holder when inserted.  
Unscrew the cap of the tube holder, insert the tube into the tube holder, ensuring the black arrow on the tube is pointing towards the open end which will connect to the instrument. Screw the cap and tube onto the instrument.
- Press "START" to commence the test cycle. A countdown timer will indicate the remaining test time, and a live tube reading will be displayed. Please note that this live reading is for indication only. It is only the final reading at the end of the test cycle that should be used as reference. The final reading will automatically be data logged.
- Once the countdown has completed, the instrument will display the final reading. Select "OK" to proceed.  
Once the measurement has finished, the display will prompt the user to remove the used tube. Press "OK" to return to the main screen once the tube has been removed and the probe has been refitted.  
The selected gas will appear briefly to indicate to the user the selected gas configuration, then return to the main Select running screen.

**Note: Please refer to the warning and note that follows the Advanced mode Tube procedure.**

#### Advanced: Tube Mode

The Advanced Tube Mode has two parts: an initial single point reading, followed by an optional 15-minute STEL calculation. Both tests use the same pre-filter tube.

The initial benzene test has a test time which varies with temperature. This test time is required to condition the tube which thereafter offer a proportional output relating to the benzene being sampled.

#### H&S function (STEL calculation)

The second stage of Tube mode is optional and can be enabled by selecting the H&S option on the configuration screen of Tiger PC (see below). The updated settings will then need to be sent to the instrument.

calculation will appear after the initial benzene test.

If selected, the option to carry out a STEL If the H&S stage is not required then press the 'No' or 'Esc' key, and the user will be instructed to remove the used benzene pre-filter tube.

The STEL for benzene will be automatically

selected from the gas table. If a benzene STEL is not specified within the selected gas table a figure can be entered on to the gas table and then sent to the instrument. To allow the table to be edited 'Allow insert/delete' must be selected from the drop down Menu found in the top of the gas table screen.

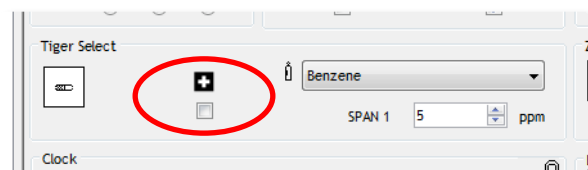



### Tube Mode Procedure:



1. To enter tube mode, select "TUBE" using the soft-key button A. At this point, the pump will stop running and the calibration-selected tube type will briefly appear, before displaying the temperature screen.
2. Adjust the on-screen temperature to reflect the ambient temperature, using the Up and Down arrow keys. The default temperature units are set to °C, however, preferred temperature units (°C or °F) are set in the Configuration screen of Tiger PC. Select "NEXT". The display will indicate for the new tube to be inserted.
3. Remove both ends of the pre-filter tube using the tube opener tool by inserting the tube into the tube opener and twisting the tube. A slight angle may be required to cut the glass.

**Note:** Should the tube break up to the shoulder, it must not be used as this will damage the seals within the tube holder when inserted.

4. Unscrew the cap of the tube holder, insert the tube into the tube holder, ensuring the black arrow on the tube is pointing towards the open end which will connect to the instrument. Screw the cap and tube onto the instrument.
5. Press "START" to commence the test cycle. A countdown timer will indicate the remaining test time, and a live tube reading will be displayed. Please note that this live reading is for indication only. It is only the final reading at the end of the test cycle that should be used as reference. The final reading will automatically be data logged.
6. Once the countdown has completed, the instrument will display the final reading. Select "OK" to proceed.  
If selected via Tiger PC, the display will provide the user with the option to run a 15 minute STEL measurement using the same pre-filter tube. Select "YES" to carry out a 15-minute STEL measurement. The STEL threshold value is taken from the internal gas table. If the user selects "NO", jump to Step 10.
7. A countdown timer will indicate the remaining test time, and a live STEL reading will be displayed. Please note that this live reading is for indication only. It is only the final reading at the end of the test cycle that should be used as reference. The final STEL reading will automatically be data logged. Once the countdown has completed, the instrument will display the STEL final reading. Select "OK" to proceed.
8. Once the measurement has finished, the display will prompt the user to remove the used tube. Press "OK" to return to the main screen once the tube has been removed and the probe has been refitted. The selected gas will appear briefly to indicate to the user the selected gas configuration, then return to the main Select running screen.

### Notes and Warnings

**WARNING:** If the level of benzene through the pre-filter tube exceeds 200 ppm the accuracy of the reading should be approached with caution. Readings above 200 ppm are still displayed, however, the display will flash ">200" in the bottom left corner of the screen.

#### **IMPORTANT:**

Pre-filter tubes should be used for one single reading and one STEL test only. Ion Science recommend that a new tube is used with each tube measurement for best accuracy and performance.

The Tiger Select should not be stored with tubes connected.

#### **Additional Notes:**

When using the Select to measure higher concentrations of benzene, the concentrations of other hydrocarbons may also be high and the pre-filter tubes capacity should be considered. As the pre-filter capacity reaches its limit, the tube will change colour from bright orange to a green / brown, as shown on the 'Filter Tubes' page. If the colour changes beyond the  $\frac{3}{4}$  marking, the benzene concentration may not be accurate. See Figure 2. If the colour turns past the  $\frac{3}{4}$  marking, as long as the benzene reading is below the test limit (e.g. 200 ppm), the result is still within the environmental compliance and the work activity can continue.

The working temperature range of the benzene pre-filter is between 2°C to 40°C (36°F to 104°F).

**\*\*Make clear re: if pump error occurs during measurement\*\***





## Tiger PC software

---

### PC Requirements

TIGER PC Software must be used in conjunction with a PC or laptop using Windows XP, Windows Vista or Windows 7.

### Installation of TIGER PC Software

Download the TigerPC software from the Ion Science website:

<http://www.ionscience.com/customer-support/media-centre/instrument-software/>

Alternatively, the TigerPC software can be purchased on a memory stick, part number: A-861268

When the memory stick is plugged into a USB socket the following screen (below) should appear. If it doesn't, view the content of the memory stick and double click the file named: ion\_cd\_Tiger.exe

On the 'TigerPC' screen (below), select 'Install TigerPC' and click OK

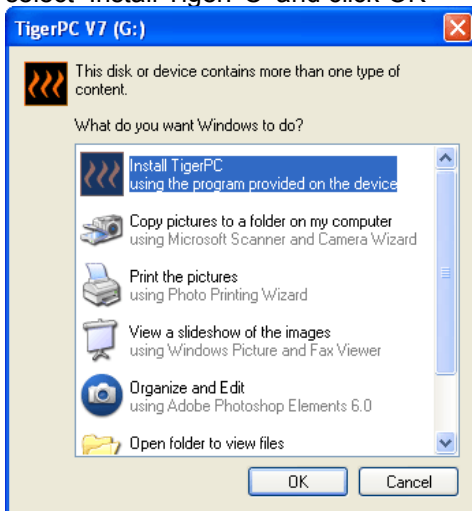

Follow the prompts until the installation is complete. Should you have difficulty please contact your local distributor: <http://ion-science-2016.gridglobal.co.uk/where-to-buy/>

Alternatively contact Ion Science directly:

<http://ion-science-2016.gridglobal.co.uk/contact/>

## Tiger PC software

---



## Connecting TIGER to a PC

1. Double click the TIGER icon on your desktop and open TIGER PC.  
The Home page should appear:



## 2. The Help Screen

This screen will show you if a new version of PC software is available. You can then install the upgrade if required.

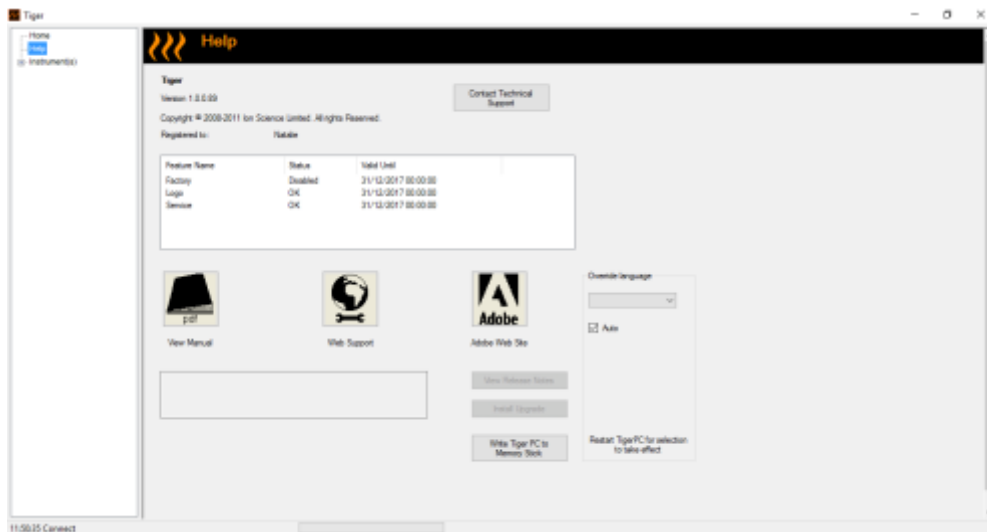



## Tiger PC software

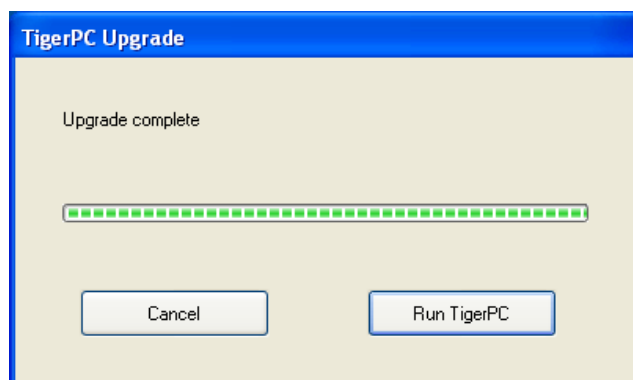
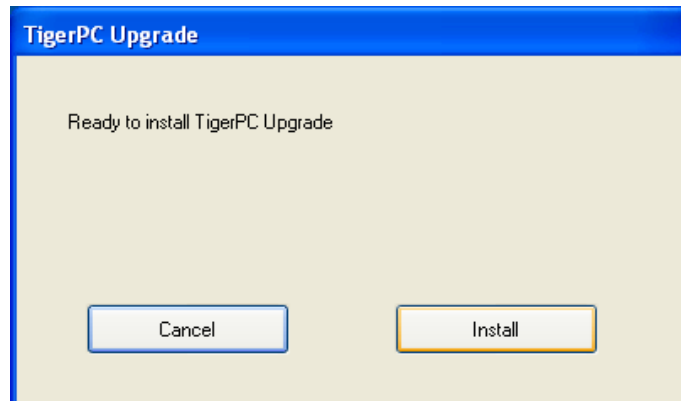

3. Switch Tiger Select on and when fully booted up connect to a USB socket on your PC using the USB cable supplied. If the 'Found New Hardware' screen appears, follow the prompts to install your instrument on your PC.
4. Click on 'Instruments' and then 'Read'. Your instrument number will appear under 'Instrument(s)' list (if it was not there already) and the Instrument Summary page will appear.

**Note:** If, while using this software your Tiger Select should inadvertently be turned off or disconnected from your computer, click on 'Instrument(s)' again.

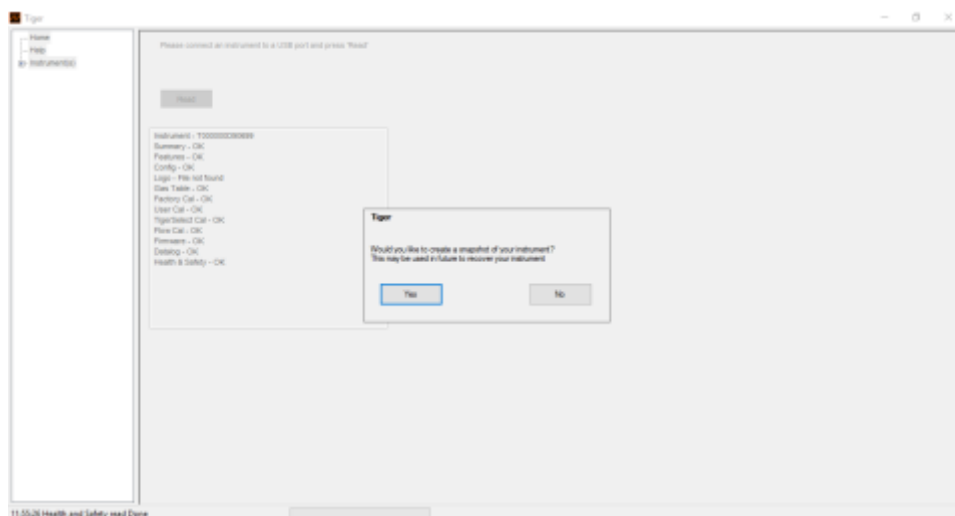



## Tiger PC software

5. **Summary screen:** this page gives the current status of your Tiger Select. If the 'snapshot' screen appears click 'Yes'. You can delete the snapshot later if you wish (see 'TIGER PC Software').

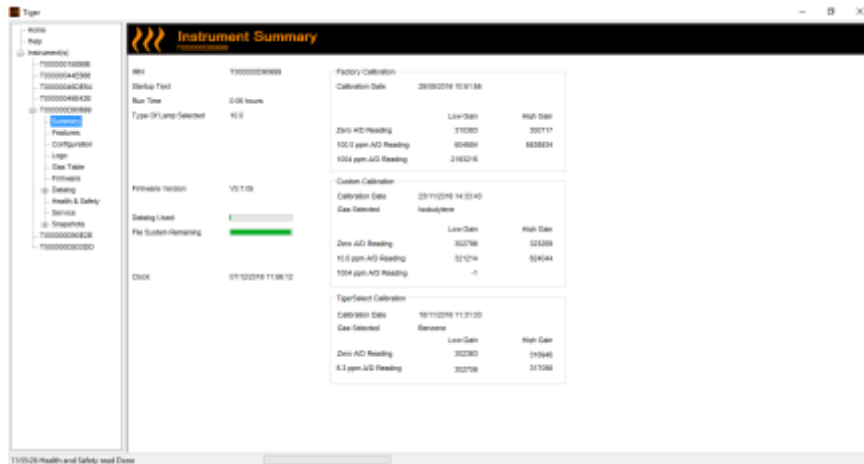

6. **Features Screen**

The 'Features' screen indicates which of the available features have been added to your Tiger Select. Should you wish to purchase additional features, contact Ion Science Ltd or your Distributor. Some updates may be available on the website [www.ionscience.com](http://www.ionscience.com). Once the transaction is complete and confirmed, click on 'Update' to add the relevant features to your Tiger Select.

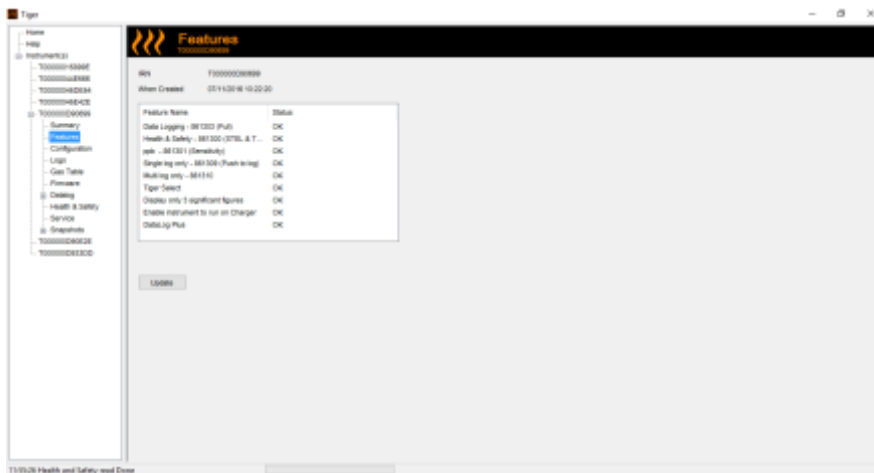



## Tiger PC software

### 7. Configuration Screen

Use this screen to configure your Tiger Select.

#### Backlight

Choose from 'Permanently Off', 'Permanently On', 'On in low ambient Light', or 'On For Limited Time'. The Backlight Timeout can be set from 1 to 99 seconds.

#### Sound

The three icons represent: key press; alarm; and crescendo. Crescendo increases the sound as the upper alarm is approached. Sound on each of these may be enabled or disabled by ticking or un-ticking the box. Sound volume is adjusted with the slider. User set alarm conditions are triggered and also reset based on the alarm thresholds set by the user. When 'Alarm latch' is selected alarms continue to sound even if the gas level falls below the threshold until the 'Esc' button is pressed.



#### Units

The units of measurement may be chosen as parts per million (ppm) or milligrams per cubic meter cubed ( $\text{mg}/\text{m}^3$ ). If you have the high sensitivity option / upgrade then Parts Per Billion (ppb) and Micrograms per meter cubed ( $\mu\text{g}/\text{m}^3$ ) are also available.

**IMPORTANT:** when ppb mode is selected the instrument over ranges at 9999 ppb (1 ppm)

#### Lock

The Lock function allows a supervisor to restricts access to critical functions that are configured to Button B.

#### Sleep

Sleep during PC connect will send the instrument into sleep mode while it is connected to the PC software. The instrument will awaken as soon as it is disconnected from the PC software.



## Tiger PC software

### Tiger Select

The Tiger Select Tube gas selection settings can be configured via this section. There is also a tick box to enable the STEL option to appear at the end of the initial Tube Mode measurement.

The user can choose which mode of operation the configuration screen appears in:

- Basic:* Always start in Basic mode
- Adv:* Always start in Advanced mode
- Ask:* Software asks which mode during startup

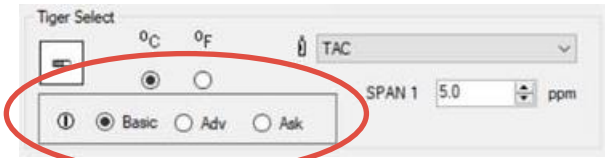

### Zeroing

This function allows either an assumed constant zero or for the zero to be tracked compensating for the shift in the zero of the PID lamp during operation. The function may be enabled or disabled by ticking or un-ticking the box. Constant or tracked zero is selected by use of the radio buttons associated with the icons.

There are various options for zeroing a TIGER Select. The symbols below are found on the configuration screen of TIGER PC.

#### Zero at switch on

When selected, the Tiger Select will automatically set its zero reading based on ambient air. When deselected the instrument will use its calibration zero.

#### Fixed zero

When selected, Tiger Select uses the fixed calibration Zero. If used in conjunction with the 'Zero at switch on' feature the instrument will zero at switch on and then remain at that level.

#### Zero tracking

When selected, the Zero level will move negative if a cleaner ambient air is detected. This ensures 0.0 ppm is displayed in clean air and ensures sub ppb levels are always detected.

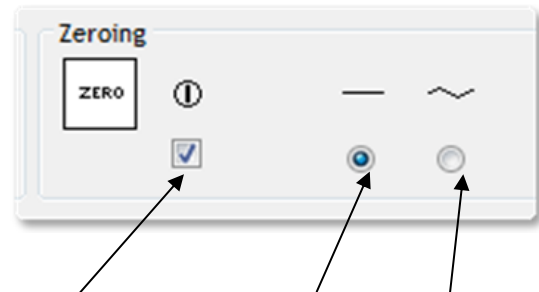

Zero at switch on    Fixed zero    Zero tracking

### Clock

Select 24 or 12 hour format using the radial buttons. Set the time and date and tick the box on the right to set the time on your Tiger Select.

Alternatively, the instrument can be set synchronise its time with the host computer.

Synchronise with computer

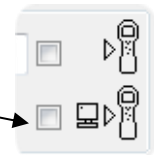

### Lamp

The Select is configured for use with the 10.0eV lamp only.

### Soft Menu

Functions on the Tiger Select instrument can be configured to the B button by dragging and dropping the functions into B area on the configuration screen. Alternatively, they can be moved to the 'Neither' area if not required. Features in the 'Neither' area do not appear on the instrument.

### Data log

*Interval:* Use this area to set the interval between readings, the minimum time permitted is one second.

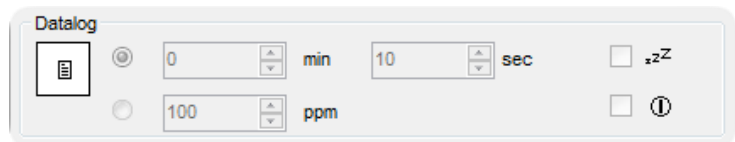

*Sleep:* When the interval between data log is >2 minutes the sleep (zZ) function becomes available. When selected, the instrument will sleep between logs therefore preserves battery life.

*ppm:* By selecting 'ppm' the instrument starts data logging at a 1 second interval for as long as the ppm gas level is exceeded.

*On/off:* The instrument starts data logging when the instrument is switched on.



### Log Full

If you select the bell symbol your Tiger Select will alarm when the memory log is full. Alternatively, if you wish new data to overwrite the oldest stored data in the memory and continue to store new data during data-logging, select the recycle symbol.

### Zones

Use this table to define and name up to 128 separate zones. The name field is limited to eight characters including spaces.

### Vibrate

To set your Tiger Select to vibrate under alarm conditions select the 'vibrate' symbol.

### TWA STEL

Select the appropriate regulatory code to which you are working.

### Calibration

Use this area to define your Custom Calibration parameters.

If no gas is shown in the drop down box, browse your system to find the gas table for your instrument. Go to the location where the TIGER PC software files are saved. Follow the path:

IonScience/TIGER/software/instruments/serial no./gas table

Select the appropriate instrument number and open the Gas Table.

Select the calibration gas using the drop-down box.

TIGER PC offers a two-point calibration (zero + span 1) or three-point (zero + span 1 + span 2) calibration. Enter the SPAN 1 concentration. For two-point calibration ensure that the box is un-ticked. For three-point calibration tick the box and enter the SPAN 2 concentration.

Select "send to instrument" to save these settings to your Tiger Select. The calibration procedure is detailed under the 'Calibration section of this manual.

### Startup Text

Enter the text you wish to appear on the start-up screen of your Tiger Select.

### Send to Instrument

When you have configured your instrument or completed your changes, send them to your Tiger Select by clicking the 'Send to Instrument' box. If the message 'There was a problem sending to the instrument' appears, click OK and return to the Home screen. Repeat the procedure under 'Connecting your Tiger Select to a PC' above. If the 'Summary' screen for your Tiger Select appears, visit the configuration screen again. If not, repeat the entire procedure. If your PC still fails to read or write to your Tiger Select seek advice from your distributor or from Ion Science Ltd.



## Tiger PC software

### The Gas Table Screen (including setting alarm levels)

Connect your Tiger Select to your PC as described previously.

Select 'Gas Table' from the menu to display the Gas Table.

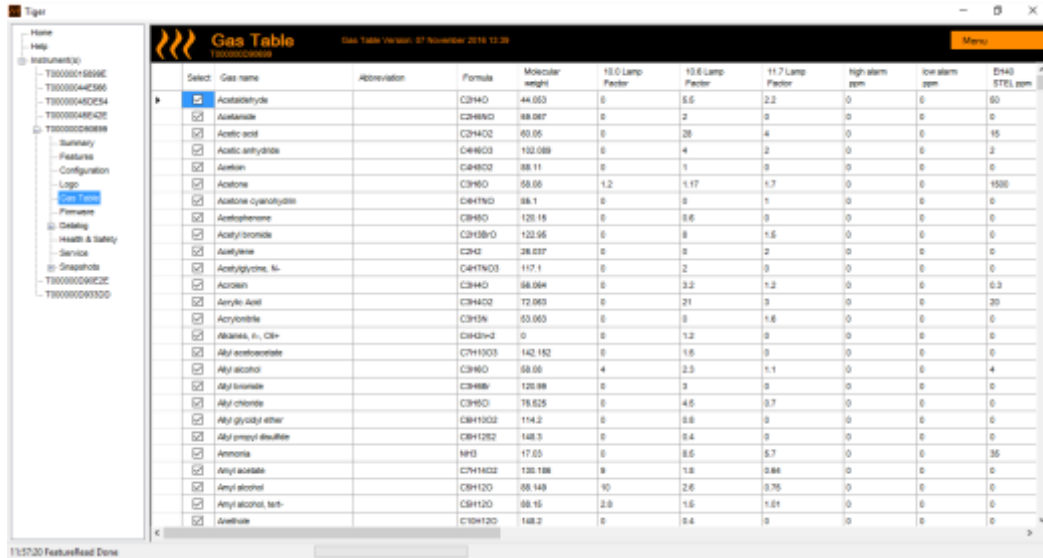

You are now able to modify this table and then download it to your instrument.



If you wish to add new gases to the table, select the 'Menu' tab, and from the drop down menu select 'Allow Insert/Delete'.

This will add an additional line at the bottom of the Gas Table which allows the user to add new gas types as below.

	Xylene mixed is...		C8H10	106	0	0.43
	Xylene, m-		C8H10	106	0.4	0.439
	Xylene, o-		C8H10	106	0.689	0.6
	Xylene, p-		C8H10	106	0.62	0.55
	Xylidine, all		C8H11N	121	0	0.699
	New gas	Mix				

Upper and lower alarm levels can be adjusted via the Gas Table. Type the desired alarm level in the appropriate column (either high or low alarm) against the gas you wish to change.

Always save modified gas tables under a different file name, keeping the original complete.

**Note:** To ensure the required gases display on the instrument, the tick box next to the gas names must be selected.

To send the Gas Table to the instrument, select 'Send to Instrument' from the dropdown menu shown above.





## Tiger PC software

### The Firmware Screen

This screen displays the current firmware version installed on your Tiger Select. It also provides a facility to download updated versions to your Tiger Select.

At this point you can also check the 'View Release Notes' information which is a description of the changes in the new version.

To download a firmware update, connect Tiger Select to your computer as detailed previously. Ensure that your instrument is in normal operation, is not in an alarm condition and that no data-logging or Health and Safety readings are being collected. Check that the battery pack is sufficiently charged (at least two bars).

**IMPORTANT:** The 'Firmware' upgrade process will delete all data from the instrument. To avoid loss of any data during the upgrade process, take a snapshot of the instrument before proceeding. The snapshot can be re-installed after the update process is complete.

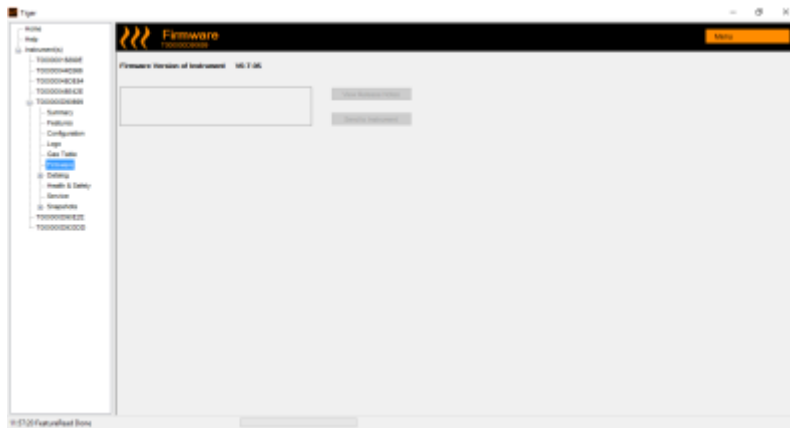

When you are ready to send the new Firmware to the instrument. Select 'Send to Instrument'.

You will now see a message that will warn you that all the data will be lost on your instrument. If you are happy to continue confirm with 'Yes'.

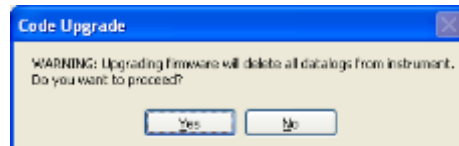

A 'WARNING' message will appear. If you are happy to continue confirm with 'Yes'.

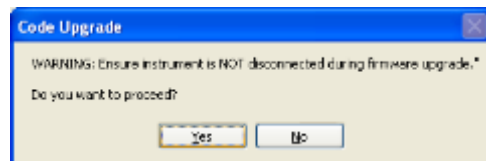



## Tiger PC software

---

**IMPORTANT:** Do not attempt to operate your Tiger Select during the update process.

The firmware on your Tiger Select will be updated and the new version will be shown on the 'Firmware' screen.

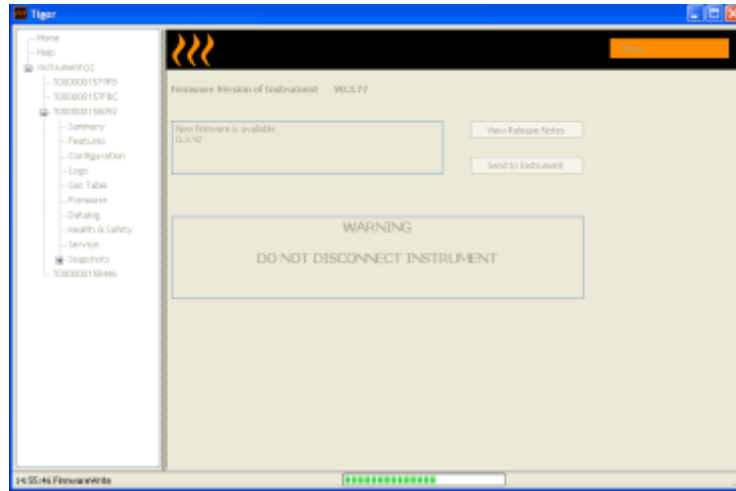

A bar at the bottom of the screen will indicate the progress of the update.

**IMPORTANT:** Do not disconnect the Tiger Select at this point. Please follow the next part before disconnecting the Tiger Select.

After the PC Software has completed sending the upgrade to the Tiger Select the instrument will then have to finish the upgrade process. The Tiger Select will flash the two torch LED's and the screen on the Tiger Select will remain blank for approximately 30 Seconds. A bar will then appear and travel across the screen. A message will be displayed as follows, 'verifying file system'. The Firmware is now installed on to the instrument and will start up automatically.





## Tiger PC software

### Downloading Data Logged Readings

Connect your Tiger Select to your PC as described previously. Any fresh data-logged readings will be downloaded as the software 'reads' your Tiger Select.

Go to the datalog screen and a list of the datalog sessions is presented.

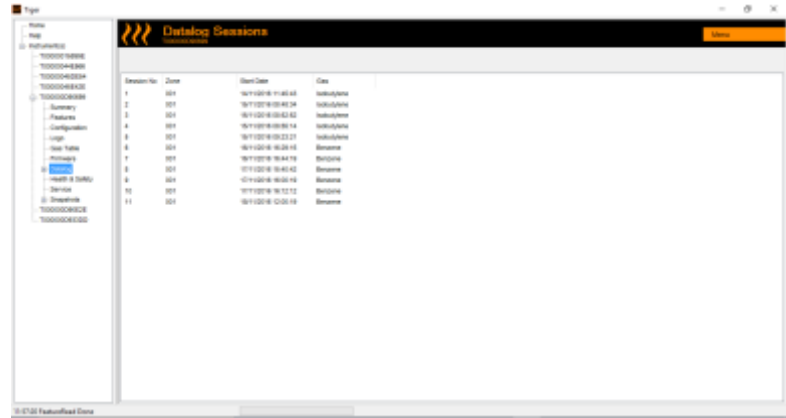

Expand the datalog folder and select the session of interest.

Details of the data collected during that session are presented in numerical and graphical form.

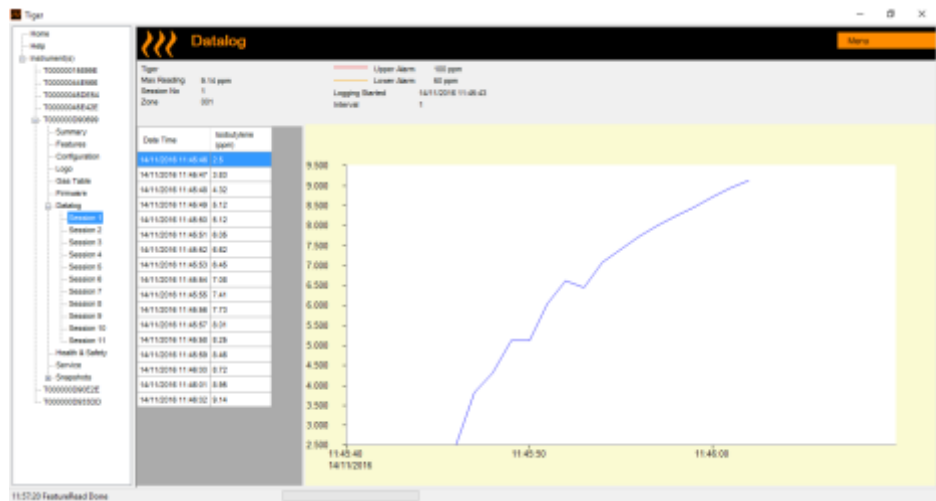

Use the menu function at the top right hand corner of the window to print, export or delete the data.

**CAUTION:**

The delete function deletes all logged data from your Tiger Select. Ensure all valuable data is exported to your PC before selecting 'Delete'.



## Tiger PC software

### The Health Safety Screen

This screen displays the latest Health and Safety readings held on your Tiger Select. Click 'Menu' then 'Export' to save this data to a file on your computer. The next readings will overwrite the data on your Tiger Select.



### The Snapshots Screen

A snapshot records the settings and calibration data on your Tiger Select at any particular point in time. The 'Snapshots' screen displays a list of all those stored on your PC.

Click 'Delete' to remove a selected snapshot.

To restore the stored settings to your Tiger Select, first ensure that your instrument is fully booted and connected to your PC as detailed previously. Ensure that your instrument is in normal operation, is not in an alarm condition and that no data logging or Health and Safety readings are being collected. Click 'Restore' against the relevant snapshot

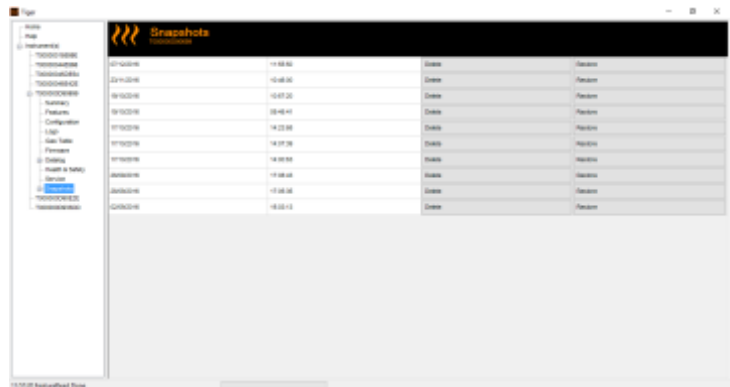

**Be aware that this process will replace all setup and calibration files**

On the restore screen click 'Yes'. When complete, click 'Close' and restart your Tiger Select. Your Tiger Select will now be restored to the settings and calibration data stored at the time of that snapshot.

The snapshot menu also allows review of stored data when an instrument is not attached.

Expand the menu until the latest or relevant snapshot is displayed. Double-click on the snapshot and all the data stored in that snapshot can be accessed.



## **Tiger PC software**

---

### **Software Disclaimers**

#### **Termination of Software Licence**

This License is effective until terminated. This License will terminate automatically without notice from Ion Science Ltd if you fail to comply with any provision of this License. Upon termination, you agree to destroy, delete or purge the written materials and all copies of the SOFTWARE, including modified copies, if any.

#### **Disclaimer of Warranty**

The SOFTWARE and accompanying materials (including the user's manual) are provided "as is" without warranty of any kind including the implied warranties of merchantability and fitness for a particular purpose, even if Ion Science Ltd have been advised of that purpose. Furthermore Ion Science Ltd does not warrant, guarantee, or make any representation regarding the use, or the results of the use, of the SOFTWARE or written materials in terms of correctness, accuracy, reliability, current revision, or otherwise. Ion Science Ltd specifically does not warrant the SOFTWARE after you assume operation. If the SOFTWARE or written materials are defective you, not Ion Science Ltd or its dealers, distributors, agents, or employees, assume the entire risk and costs of all necessary servicing, repair, or correction, except as stated below.

#### **Defective Memory Stick (if purchased)**

As the only warranty under this Agreement, Ion Science Ltd warrants, to the original Licensee only, that the Memory Stick(s) on which the software is recorded is free from defects in materials and workmanship under normal use and service for a period of ninety (90) days from the date of delivery as evidenced by a copy of the Receipt. This limitation will apply where allowed.

#### **Replacement of Defective Memory Stick (if purchased)**

Ion Science Ltd entire liability and the original Licensee's exclusive remedy under this agreement are at the discretion of Ion Science Ltd, to either (a) return of payment as evidenced by a copy of the Receipt, or (b) replacement of the memory stick that does not meet Ion Science Ltd limited warranty and which is returned to Ion Science Ltd with a copy of the Receipt. If failure of the memory stick has resulted from accident, abuse, or misapplication, Ion Science Ltd will have no responsibility to either replace the item or refund payment. Any replacement memory stick will be warranted for the remainder of the original warranty period or thirty (30) days, whichever is longer. This warranty gives you limited, specific legal rights. You may have other rights in some places.

#### **No Right to Reply**

No oral or written information or advice given by Ion Science Ltd, its dealers, distributors, agents or employees will create a warranty or in any way increase the scope of the obligations of Ion Science Ltd under this agreement, and you may not rely on any such information or advice.

#### **Limitation of Liability**

Ion Science Ltd will not be liable for any direct, indirect, consequential or incidental damages (including damages for loss of business profits, business information, or possibility of such damages). The above limitation will apply where allowed under local laws.

#### **Governing Law**

The laws of the United Kingdom govern this Agreement.



## Batteries

### Warnings

<b>BATTERY CHARGING:</b>	Charge Tiger Select and its Lithium ion battery packs in a Non Hazardous environment only.
<b>BATTERY REPLACEMENT:</b>	Never replace primary Alkaline battery cells while in a potentially explosive or hazardous location. Use only Duracell Procell Alkaline batteries MN1500.
<b>BATTERY CONNECTION:</b>	The Tiger Select Lithium ion and Alkaline battery packs have been specially designed to allow connection to the Tiger Select Instrument while in potentially hazardous atmospheres. The Tiger Select instruments ingress protection rating is reduced to IP 20 when its battery pack is removed so avoid changing batteries in dusty or wet environments.

Two battery packs are available for use with the Tiger Select instrument. A lithium ion Rechargeable Battery Pack (**A2**) and non-rechargeable AA Battery Pack (**A3**), (that may be fitted with 3 AA Alkaline batteries). The rechargeable pack is recommended for normal operation with the Non-rechargeable pack available when power is not available and the use of the instrument is needed. The rechargeable pack is normally fitted as standard to the instrument when shipped.

### Recharging Batteries

Ensure the Tiger Select is charged for at least 7 hours before using it for the first time. To ensure optimum charging the Tiger Select should be switched off during charging. If left on, the Tiger Select will take longer to charge, but should not suffer any damage. The Tiger Select should be charged in a non-hazardous environment only.

To charge your Tiger Select, first connect the Charger Cradle (**A4**) to the mains, and switch on. A red light will indicate that the charger is ready. Place the Tiger Select in the Charger Cradle such that the contacts on the Tiger Select are aligned with those in the cradle. (There is no need to remove the Instrument Boot (**8**) from the Tiger Select during charging.) During charging, the charger will display an orange light. A green light indicates that charging is complete.

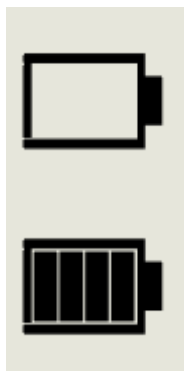

Discharged

The battery icon on the Tiger Select will display the level of charge.

Fully Charged

- Note:**
1. Only use the Charger Cradle supplied with your Tiger Select to charge your instrument.
  2. Ion Science Ltd recommends keeping your Tiger Select on charge at all times when not in use, as batteries can lose power over time.



## Batteries

### Replacement / Exchange of Battery Packs

To replace the Rechargeable Battery Pack (**A2**), proceed as follows:

- a. Ensure Tiger Select is switched Off;
- b. Remove the Instrument Boot (**8**) from your Tiger Select (this is most easily achieved by starting at the front end of the instrument (step 4 below));
- c. Release the clip at the rear end of the instrument and lift the Rechargeable Battery Pack (**A2**) away from the Instrument Body (**A1**), coincidentally sliding it slightly backwards;
- d. Reverse the procedure to install the replacement battery pack ensuring that the Boot is a snug fit around the front of the instrument and the lights are not obscured;
- e. Charge the Tiger Select for 7 hours before use.

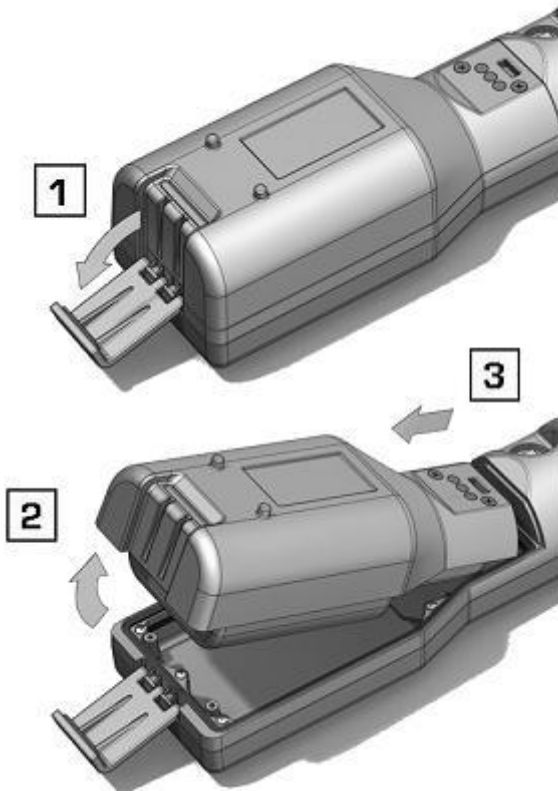

Item numbers in (bold) refer to the illustrations and parts list on page 41.



## Batteries

### Replacement of Non-rechargeable Batteries in Battery Pack

#### **WARNING**

**BATTERY REPLACEMENT:** Never replace primary Alkaline battery cells while in a potentially explosive or hazardous location. Use only Duracell Procell Alkaline batteries MN1500.

- a. Ensure Tiger Select is switched Off.
- b. Remove the AA Battery Pack (A3) as in (b) and (c) on page 34;

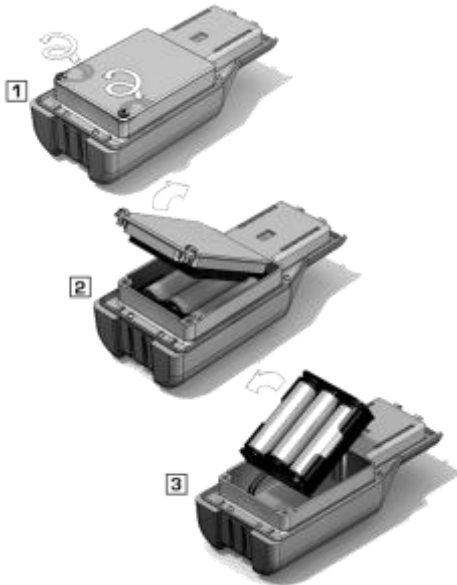

- c. Remove the screws retaining the battery cover and lift it off. This reveals a set of 3 x AA cells contained in a removable battery holder;
- d. Remove the battery holder;
- e. Replace the exhausted batteries; Use Duracell PROCELL Alkaline batteries MN1500
- f. Check all batteries have the correct polarity before replacing the battery holder;
- g. Assemble the battery holder into the AA Battery Pack (A3), refit the battery cover and fix in place using the securing screws. Replace the Instrument Boot (8) ensuring that it is a snug fit around the front of the Instrument Body (A1) and the lights are not obscured.

**CAUTION:**  
Fitting batteries or connecting the battery pack with the wrong polarity may result in damage to the instrument!

**CAUTION:**  
Non-rechargeable batteries must not be replaced in the field. Batteries should be loaded into the battery holder in a safe environment only. Only the assembled AA Battery Pack (A3) may be changed in the field.

**CAUTION:**  
Do not make any connections to the USB port of this instrument whilst in a hazardous area.

**Note:** When loading batteries check for correct battery polarity before connecting them.

**Note:** Dispose of used batteries in accordance with all local and national safety and environmental requirements.





## Diagnosics

---

Basic faults or diagnostics are presented as symbols. Should a fault occur most can be corrected by pressing **Enter** or **Esc** to clear the fault message. All fault conditions cause the Tiger Select to alarm.

### Pump failure



#### ***Pump blocked or pump failure***

The flow of gas through the instrument has fallen below 50cc/minute. Check the probe and filter for signs of blockage. Water or dirt in the probe, a bent probe, dirty filter on the inlet or blockage of the exhaust can all cause low flow. If the blockage can be removed, press **Esc** to clear the alarm. If the fault persists send the instrument to your distributor for service.

### Battery dead



#### ***Battery low or battery failure***

The Tiger Select will shut down when the battery level falls below 2%. Recharge the battery as instructed in the 'Batteries' section of this manual ensuring that all connections are sound and the indicator lights on the charger are in order. If the battery fails to charge, fit another battery pack if available. If using alkaline batteries, replace them. If the fault persists send the instrument and charger to your distributor for service.

### Lamp out



#### ***Lamp failure***

The PID lamp has failed to strike (illuminate); this may occur at switch on or during use. Try switching the Tiger Select off and on. If this fault persists then the lamp should be replaced. (See the 'Maintenance' section)

### Memory full



#### ***Memory cannot receive more data***

The data log memory is full. This will only happen if the Log Full box is set to 'alarm' on the Tiger PC configuration screen. Press the **Esc** key to continue, but the Tiger Select will no longer continue to log data. Select 'recycle' in Tiger PC and the Tiger Select will overwrite the oldest data and no alarm will be raised.

### System error



#### ***Total system failure***

The instrument's firmware is corrupted. In the unlikely event of this message appearing, contact Ion Science Ltd or your nearest authorised service centre.



## Maintenance

### Inlet Probe assembly

All component parts of the probe assembly can be replaced if they become damaged or contaminated with use.

### PTFE Filter Disc

The Filter Disc should be changed after every 100 hours of use. This frequency should be increased for dusty or moisture laden environments or whenever the filter appears 'dirty'.

Filter Disc changing should be conducted in a suitably clean environment, with clean hands and equipment to avoid contamination of the new Filter Disc.

To change the Filter Disc, unscrew the Filter Housing Cap, lift off the Filter Clamp and O-Ring and lift the Filter Disc from the Instrument Body. Carefully place a new Filter Disc into the Instrument Body. ***(Under no circumstances should a Filter Disc be used once it has been removed.)*** Replace the Filter Clamp, ensuring that the O-Ring is correctly seated. Replace the Filter Housing Cap. Do not over-tighten.



### Probe Seal

The Probe Seal should be inspected and replaced when required.



## Maintenance

### PID Sensor/Lamp Replacement and Cleaning

In normal use the lamp should be cleaned after every 100 hours of use (based on 30 ppm for 100 hours). Reduce this if Tiger Select is used in heavily gas contaminated environments. Please note that some esters, amines and halogenated compounds may accelerate window fouling; in these cases cleaning may be required after every 20 hours of use. Cleaning frequency will also depend upon alarm levels set and prevailing environmental conditions.

#### CAUTION!

**The Tiger Select is a sensitive detector. Internal components must be handled with clean hands and clean tools. The Tiger Select lamp is fragile. Please handle with great care. Never touch the window and do not drop.**

To remove the Mini PID sensor for cleaning or lamp replacement, first ensure that the Tiger Select is turned off and that you are in a clean environment such that the sensor parts will not be contaminated by dust, oil or grease. Remove the Sensor Cover (see image on right). The centre screw may be turned with a small coin or a suitable flat bladed screwdriver.

Ensure that the Sensor Seal, on the inside of the Sensor Cover is not disturbed.

Carefully lift the Mini PID sensor from the Instrument Body, ensuring that the two Inlet/Outlet Seals remain in place in the Instrument Body.

Using the Mini PID electrode stack removal tool (846216) provided, and locate its 'prongs' in the slots in the side of the Mini PID sensor body. Using the forefinger to restrain the sensor, (the internal parts are spring-loaded and careless disassembly may result in loss of the spring or lamp) squeeze the tool to release the lamp housing.

The lamp may now be removed.

To replace the lamp or install a new one, firstly, place the electrode stack onto a clean, flat surface. Carefully, twist the lamp into the electrode stack o'ring so that the lamp window now sits flush within the electrode stack. The mini PID may then be aligned over the electrode stack and lamp, and pushed down to secure the assembly; two clicks should be heard. When replacing the Sensor Cover ensure that the markers are aligned correctly and that the cover is a snug fit. Sealing of the Sensor Cover against the PID is important, the cover must be tightened to 70 cN.m +/- 10%.

The instrument MUST be re-calibrated after fitting a replacement or cleaned lamp.

#### CAUTION!

**Never refit a damaged lamp!**





## Maintenance

---

### Lamp Cleaning

The Tiger Select Mini PID relies on an ultraviolet light source ionising VOC gases as they pass across the lamp window. This process may result in a very fine layer of contamination appearing on the detector window that must be removed on a regular basis.

#### CAUTION!

**The Tiger Select is a sensitive detector. Internal components must be handled with clean hands and clean tools. The Tiger Select lamp is fragile. Handle with great care!**

First ensure that the Tiger Select is turned off and that you are in a clean environment such that the sensor parts will not be contaminated by dust, oil or grease.

Remove the lamp as detailed within the 'PID Sensor/Lamp Replacement and Cleaning' section of this manual.

Inspection of the lamp may reveal a layer of contamination on the detection window that presents itself as a 'blue hue.' To check for confirmation, hold the lamp in front of a light source and look across the window surface. Clean the window using the PID Lamp Cleaning Kit (A-31063) supplied.

To clean the lamp:

1. Open the vial of Aluminium Oxide polishing compound. With a clean cotton bud collect a small amount of compound;
2. Use this cotton bud to polish the PID lamp window. Use a circular action applying light pressure to clean the lamp window. Never touch the lamp window with fingers;
3. Continue polishing until an audible "squeaking" is made by the cotton bud with compound moving over the window surface (usually within fifteen seconds);
4. Remove the residual powder with short blast of air from the can of air duster;
5. The instrument MUST now be re-calibrated.



### Use of PID Lamp Cleaning Kit A-31063

*The container of cleaning compound contains Aluminium Oxide as a very fine powder (CAS Number 1344-28-1).*

*A full material safety data sheet MSDS is available on request from Ion Science Ltd. The key issues are listed below. Always replace the lid after using the cleaning compound.*

#### Hazard identification:

- May cause irritation of respiratory tract and eyes.

#### Handling:

- Do not breathe vapour/dust. Avoid contact with skin, eyes and clothing;
- Wear suitable protective clothing;
- Follow industrial hygiene practices: Wash face and hands thoroughly with soap and water after use and before eating, drinking, smoking or applying cosmetics;
- The Compound has a TVL(TWA) of 10 mg/m<sup>3</sup>.

#### Storage:

- Keep container closed to prevent water adsorption and contamination.



## Parts list

### PID sensor access and batteries



ITEM	DESCRIPTION	PART NUMBER	QTY
A1	Instrument body	A-8611274	1
A2	Rechargeable battery pack	A-861240	1
A3	AA battery pack	A-861241	1
A4	Charge cradle	A-861220	1
A5	Sensor cover	A-861259	1
A6	MiniPID 2 sensor	MP6SX60XU2	1
7	Sensor gasket	861203-9	1
8	Instrument boot	861205	1
9	Sensor seal	A-861214	1
10	Inlet / outlet seal	861215	2
11	Filter housing cap	861218	1
12	Filter clamp	861579	1
13	Filter disc	861616	1
14	Probe - Tiger	880207	1
15	O-ring	5/OV-2	1
16	Probe seal	880202	1
17	Tube holder probe	A-880209	1
n/a	Benzene pre-filter tubes (pack of 10)	861614	1



## Parts list

---

Tube holder assembly with part numbers

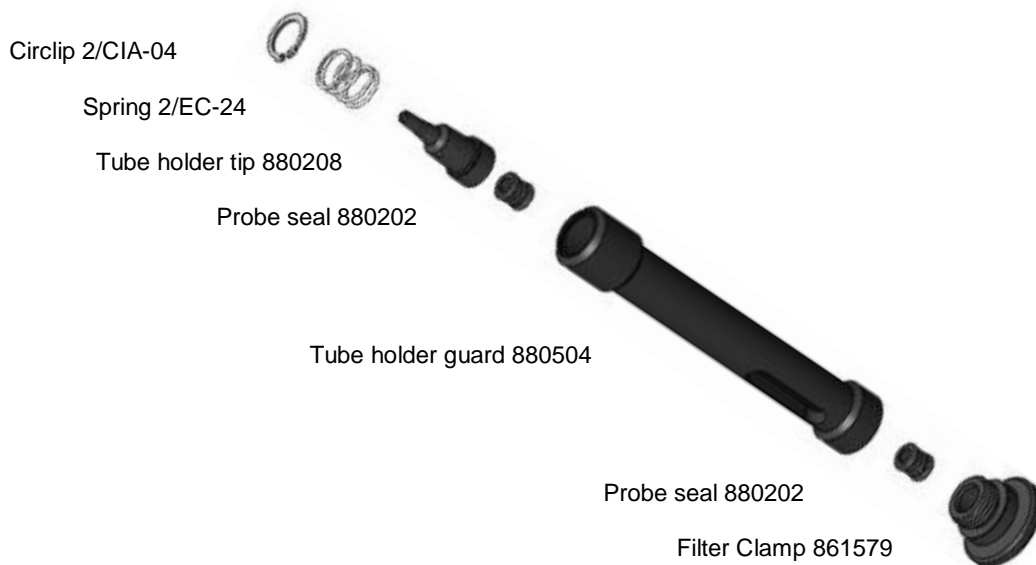

## Instrument warranty and service

---

### Warranty

Standard Warranty can be extended to up to 5 years on the Tiger Select when registering your instrument via our website: [www.ionscience.com/instrument-registration](http://www.ionscience.com/instrument-registration) To receive your Extended Warranty, you need to register within one month of purchase (Terms and Conditions apply).

To register your Tiger Select instrument, simply fill in the online form. You will need to enter your instrument serial number. The serial number is located on the front label of the instrument, towards the bottom end of the unit. Beneath the bar code, there will be a number beginning with T- followed by 6 digits. (E.g.T-123456).

You will then receive a confirmation email that your Extended Warranty Period has been activated and processed.

Full details, along with a copy of our Warranty Statement can be found by visiting:

[www.ionscience.com/instrument-registration](http://www.ionscience.com/instrument-registration)

### Service

At Ion Science Ltd we recommend that all of our gas detection instruments be returned for service and factory calibration once every 12 months.

Contact Ion Science Ltd or your local distributor for service options in your area.

Find your local distributor by visiting: [www.ionscience.com](http://www.ionscience.com)



## Contact details

---

### Head Office (UK)

Ion Science Ltd  
The Hive, Butts Lane,  
Fowlmere  
Cambridge  
SG8 7SL  
UK  
**Tel:** +44 (0)1763 208503  
**Fax:** +44 (0) 1763 208814  
**Email:** [info@ionscience.com](mailto:info@ionscience.com)  
**Web:** [www.ionscience.com](http://www.ionscience.com)

### US Corporate HQ

Ion Science Inc  
4153 Bluebonnet Drive, Stafford  
Texas  
77477  
USA  
**Tel:** +1 877 8647710

**Email :** [info@ionscienceusa.com](mailto:info@ionscienceusa.com)  
**Web:** [www.ionscience.com](http://www.ionscience.com)

### German Office

Ion Science Messtechnik  
GMBH  
Laubach 30  
Metmann-Neandertal  
40822  
GERMANY  
**Tel:** +49 2104 14480  
**Fax:** +49 2104 144825  
**Email:** [info@ism-d.de](mailto:info@ism-d.de)  
**Web:** [www.ism-d.de](http://www.ism-d.de)

### Italian Office

Ion Science Italia  
Via Emilia 51/c  
40011 Anzola Emilia  
Bologna  
ITALY  
**Tel:** +39 051 0561850  
**Fax:** +39 051 0561851  
**Email:** [info@ionscience.it](mailto:info@ionscience.it)  
**Web:** [www.ionscience.it](http://www.ionscience.it)



## Technical specification

<b>Response time:</b>	130 seconds at 20 °C (variable)
<b>Detectable</b>	0 ppm up to 20,000ppm (for specific gases)
<b>Range:</b>	0 to 200 ppm benzene in Tube mode
<b>Minimum</b>	<b>PPM model:</b>
<b>Resolution:</b>	Standard running mode 0.1 ppm TAC 0.01 ppm Tube 0.001 ppm
	<b>PPB model:</b>
	Standard running mode 0.001 ppm TAC 0.001 ppm Tube 0.001 ppm
<b>Accuracy*:</b>	+/- 10% displayed reading +/- one digit benzene
<b>Linearity*:</b>	+/- 5% displayed reading +/- one digit
<b>Battery:</b>	Lithium ion: 24 hours Alkaline (Duracell Procell MN1500): 8.5 hours
<b>Data log:</b>	120,000 (including date / time)
<b>Alarm visual:</b>	Flashing Red and Amber LED
<b>Alarm audible:</b>	95 dBA at 300 mm
<b>Flow Rate:</b>	≥ 220 ml/min in ambient conditions
<b>Temperature:</b>	Operating: -20 to 60 °C (-4 to 140 °F) Storage: -25 to 60 °C (-13 to 140 °F) Certified to: -15 to 45 °C (-5 to 140 °F)
<b>Dimensions:</b>	Instrument: 370.0mm / 14.56" (H) 91.4mm / 3.59" (W) 61mm / 2.40" (D)
<b>Weight:</b>	Instrument: 0.75 kg (1.6 lb)
<b>Materials:</b>	Instrument: Anti-static PC/ABS (Polycarbonate/ Acrylonitrile Butadiene Styrene) Rubber Boot: Anti-static TPE (Thermoplastic Polyolefin Elastomeric)





## Manual log

---

Version	Amendment	Date of issue	Instrument firmware	PC software
3.0	New manual version	03/11/2016	V0.8.07	V1.0.07

**Disclaimer:** Information in this [manual, document...] is subject to change without notice and does not represent a commitment on the part of Ion Science. No claims, promises or guarantees are made about the accuracy, completeness, or adequacy of the information contained herein.

Part number: 861489