

SenSmart 6000 DUAL CHANNEL SENSOR TRANSMITTER

(Built with our Proven ST-44 Transmitter)



“AL” Model



“PY” Model



Warning: Read & understand contents of this manual prior to operation. Failure to do so could result in serious injury or death.

(Page intentionally left blank.)

| | |
|---|-----------|
| Chapter 1 Safety Information | 1 |
| 1.1 Safety Information – Read Before Installation and Applying Power..... | 1 |
| 1.2 Contacting R.C. Systems Inc..... | 1 |
| Chapter 2 General Description | 2 |
| 2.1 Introduction | 2 |
| 2.2 Ratings and Certifications..... | 2 |
| 2.3 System Design Specifications..... | 2 |
| Chapter 3 Installation Instructions | 4 |
| 3.1 Sensor Location | 4 |
| 3.2 Mounting the Enclosure | 4 |
| 3.3 3-Wire 4-20 mA Mode Installation | 6 |
| 3.4 10-0388 Relay / RS-485 Modbus Option Installation | 7 |
| 3.5 Sensor Installation..... | 9 |
| Chapter 4 General Operating Instructions | 11 |
| 4.1 Introduction | 11 |
| 4.2 Routine Sensor Calibration..... | 11 |
| 4.3 Alarm Outputs..... | 13 |
| 4.3.1 Relay 1/2/3..... | 14 |
| 4.3.1.1 Alarm 1/2/3/FAULT | 14 |
| 4.3.1.2 Acknowledge..... | 14 |
| 4.3.1.3 Failsafe | 14 |
| 4.3.1.4 Override | 14 |
| 4.4 Channel Settings..... | 15 |
| 4.4.1 Channel 1/2..... | 15 |
| 4.4.1.1 Alarm 1/2/3..... | 15 |
| 4.4.1.1.1 Setpoint..... | 16 |
| 4.4.1.1.2 Latching..... | 16 |
| 4.4.1.1.3 Trip On | 16 |
| 4.4.1.1.4 On Delay(sec) | 16 |
| 4.4.1.1.5 Off Delay(min) | 16 |
| 4.4.1.1.6 DeadBand % | 16 |

| | | |
|------------|----------------------------|-----------|
| 4.4.1.1.7 | Color..... | 17 |
| 4.4.1.2 | Fault Alarm..... | 17 |
| 4.4.1.2.1 | Setpoint..... | 17 |
| 4.4.1.3 | Data From | 17 |
| 4.4.1.3.1 | EC Sensor..... | 17 |
| 4.4.1.3.2 | Bridge Sensor..... | 20 |
| 4.4.1.3.3 | AI 4-20mA..... | 23 |
| 4.4.1.3.4 | Modbus 16bit | 25 |
| 4.4.1.3.5 | Modbus 16 Signed | 27 |
| 4.4.1.3.6 | Modbus 32bit | 28 |
| 4.4.1.3.7 | Low Power IR..... | 30 |
| 4.4.1.4 | Temp. Comp..... | 31 |
| 4.4.1.5 | Configure..... | 32 |
| 4.4.1.5.1 | Measurement Name..... | 32 |
| 4.4.1.5.2 | E.Unit | 32 |
| 4.4.1.5.3 | Zero..... | 32 |
| 4.4.1.5.4 | Span | 32 |
| 4.4.1.5.5 | Decimal Points..... | 32 |
| 4.4.1.5.6 | Channel On? | 32 |
| 4.4.1.5.7 | Deadband (%) | 32 |
| 4.4.1.5.8 | InCal mA | 32 |
| 4.4.1.5.9 | Backup/Restore | 33 |
| 4.4.1.6 | Calibrate..... | 33 |
| 4.5 | Comm Settings | 34 |
| 4.5.1 | COM1/COM2 Settings | 35 |
| 4.5.1.1 | BaudRate..... | 35 |
| 4.5.1.2 | Parity..... | 35 |
| 4.5.1.3 | Timeout (ms)..... | 35 |
| 4.5.1.4 | Poll Dly (ms)..... | 35 |
| 4.5.1.5 | Byte Order..... | 36 |
| 4.5.1.6 | Enable LEDs..... | 36 |
| 4.5.1.7 | Slave ID..... | 36 |
| 4.5.2 | Modbus TCP | 36 |

| | | |
|------------|---------------------------|-----------|
| 4.5.2.1 | Slave Byte Order | 36 |
| 4.5.2.2 | master Timeout (ms) | 36 |
| 4.5.2.3 | master Poll Dly (ms)..... | 37 |
| 4.5.2.4 | Enable LEDs | 37 |
| 4.5.3 | Network Settings..... | 37 |
| 4.5.3.1 | DHCP Enabled..... | 37 |
| 4.5.3.2 | Hostname..... | 37 |
| 4.5.3.3 | IP Address..... | 37 |
| 4.5.3.4 | Netmask..... | 38 |
| 4.5.3.5 | Gateway | 38 |
| 4.5.4 | Troubleshooting | 38 |
| 4.5.4.1 | View fail count..... | 38 |
| 4.5.4.2 | Clear fail count | 38 |
| 4.6 | Security | 38 |
| 4.7 | System..... | 40 |
| 4.7.1 | Version..... | 41 |
| 4.7.2 | Configure | 41 |
| 4.7.2.1 | Unit Name..... | 41 |
| 4.7.2.2 | Date | 41 |
| 4.7.2.3 | Time | 41 |
| 4.7.2.4 | Warmup (m)..... | 42 |
| 4.7.2.5 | Cal PURGE (m)..... | 42 |
| 4.7.2.6 | Block Neg | 42 |
| 4.7.2.7 | Send SensrLife | 42 |
| 4.7.2.7.1 | 4-20mA output | 42 |
| 4.7.2.7.2 | Modbus Output | 43 |
| 4.7.2.8 | Alm REFRESH (m)..... | 43 |
| 4.7.3 | Digital Input..... | 43 |
| 4.7.4 | View Event Log | 44 |
| 4.7.5 | Clear Event Log..... | 44 |
| 4.8 | Technician | 45 |
| 4.8.1 | ADC Readings | 46 |
| 4.8.2 | Discrete I/O | 47 |

| | | |
|------------|--|-----------|
| 4.8.3 | Inputs | 47 |
| 4.8.4 | Sensor Life..... | 47 |
| 4.8.5 | Diagnostics | 48 |
| 4.8.5.1 | Relays..... | 49 |
| 4.8.5.2 | Analog Outputs..... | 49 |
| 4.8.5.3 | LED Test..... | 50 |
| 4.8.5.4 | Serial Ports | 50 |
| | Chapter 5 Modbus | 51 |
| 5.1 | Modbus TCP | 51 |
| 5.2 | Modbus Slave Writes..... | 51 |
| 5.3 | Modbus Slave Register Location | 51 |
| | Chapter 6 Special Features | 60 |
| 6.1 | Webpage | 60 |
| 6.1.1 | Status Screen..... | 61 |
| 6.1.2 | Event Log Screen | 62 |
| 6.1.3 | Configure | 63 |
| 6.1.3.1 | Relay Config..... | 63 |
| 6.1.3.2 | Channel Config | 64 |
| 6.1.3.3 | System Config..... | 65 |
| 6.1.3.4 | Comm Config..... | 65 |
| 6.1.3.5 | Config Transfer | 66 |
| 6.2 | Network connection | 66 |
| 6.2.1 | Direct connection with crossover cable or hub/switch | 66 |
| 6.2.2 | Connecting the SenSmart 6000 to an Existing LAN | 67 |
| 6.2.3 | Connecting the SenSmart 6000 to an Isolated Network | 68 |
| 6.2.4 | Static IP Configuration | 69 |
| 6.2.4.1 | SenSmart 6000 static ip configuration..... | 69 |
| 6.2.4.2 | Windows xp static ip configuration | 70 |
| 6.2.4.3 | Dyanmic ip configuration | 73 |
| 6.2.5 | Testing Connections | 74 |
| 6.3 | 10-0388 Relay/RS 485 Option Board | 75 |
| 6.3.1 | RS-485 Modbus Communications Ports | 75 |
| 6.3.2 | Programmable Relays..... | 76 |

| | | |
|------------|---|-----------|
| 6.3.3 | Fault Relay..... | 77 |
| 6.3.4 | Digital Input..... | 77 |
| 6.4 | 10-2080 Remote Sensor Option Board | 78 |
| 6.4.1 | Wiring the 10-2080 Remote Sensor Option Board..... | 79 |
| 6.4.2 | Remote Sensor Setup | 80 |
| 6.4.2.1 | Board Setup Menu..... | 81 |
| 6.4.2.2 | View Sensor Info Menu..... | 81 |
| 6.4.2.3 | Assign to Channel Menu | 82 |
| | Chapter 7 – Millenium Sensor Calibration | 83 |

Chapter 1 Safety Information

1.1 SAFETY INFORMATION – READ BEFORE INSTALLATION AND APPLYING POWER

The following symbols are used in this manual to alert the user of important instrument operating issues:



This symbol is intended to alert the user to the presence of important operating and maintenance (servicing) instructions.



This symbol is intended to alert the user to the presence of dangerous voltage within the instrument enclosure that may be sufficient magnitude to constitute a risk of electric shock.

WARNINGS:

- **Shock Hazard** - Disconnect or turn off power before servicing this instrument.
- **WARNING- EXPLOSION HAZARD-** DO NOT REPLACE FUSE UNLESS POWER HAS BEEN SWITCHED OFF OR THE AREA IS KNOWN TO BE NON-HAZARDOUS.
- **WARNING- EXPLOSION HAZARD-** DO NOT DISCONNECT EQUIPMENT UNLESS POWER HAS BEEN SWITCHED OFF OR THE AREA IS KNOWN TO BE NON-HAZARDOUS.
- Use a properly rated CERTIFIED AC power (mains) cable installed as per local or national codes
- A certified AC power (mains) disconnect or circuit breaker should be mounted near the controller and installed following applicable local and national codes. If a switch is used instead of a circuit breaker, a properly rate CERTIFIED fuse or current limiter is required to be installed as per local or national codes. Markings for positions of the switch or breaker should state (I) for on and (O) for off.
- Clean only with a damp cloth without solvents.
- Equipment not used as prescribed within this manual may impair overall safety.

1.2 CONTACTING R.C. SYSTEMS INC.

To contact R. C. Systems Inc., call, fax, email or write:
409-986-9800 FAX 409-986-9880 Email: info@rcsystemsco.com
8621 Hwy. 6 Hitchcock, TX 77563
Or visit us on the World Wide Web: www.rcsystemsco.com

Chapter 2 General Description

2.1 INTRODUCTION

The state-of-the art SenSmart 6000 sensor transmitter is an updated version of our proven SenSmart 3000 transmitter. This versatile unit has a bright color display and embedded web page promoting simple intuitive user interface. The web page is accessed through the standard Ethernet connection and allows the transmission of data over existing network infrastructure to computers, tablets, smart phones and RC Systems ST-72 64 channel controller.

Features include:

- QVGA color TFT display which displays engineering units and monitored data graphically as a bar graph and 30-minute trend.
- Display changes color to indicate alarm status
- Ethernet: embedded webpage for configuration and HMI, Modbus TCP master/slave
- Webpage offers offsite viewing capabilities.
- Remote sensor abilities
- Single/Dual modes standard
- Modbus TCP, Modbus RTU, EC, bridge and 4-20mA inputs
- Magnetic switches allow "one man" sensor calibration in hazardous areas without area declassification with a simple magnetic wand.

Optional features include:

- Three programmable relays and a dedicated fault relay.
- Two individually programmable RS-485 ports for Modbus master or slave.

2.2 RATINGS AND CERTIFICATIONS

NRTL CSA APPROVALS (File # 219995)

SenSmart 6000 with 10-0247 is Division 1 and 2 Group A, B, C, D Exia. Suitable for explosion proof installations

EXPLOSION PROOF HOUSING

Instrument enclosure suitable for Class 1, Division 1 and 2, Groups A, B, C and D

POLYCARBONATE ENCLOSURE

Instrument enclosure suitable for Class 1, Division 2, Groups A, B, C and D (Pending)

2.3 SYSTEM DESIGN SPECIFICATIONS

ANALOG OUTPUTS

SenSmart 6000 Bridge models have 3-wire 4-20mA current source output with nominal 24VDC power supply

10-0388 Relays / RS-485 Modbus® (Optional)

Relays are Form C 5AMP @ 30VDC and 240VAC RESISTIVE

RS-485 is 2-wire Modbus® RTU

DISPLAY

240X320 pixel LCD displays 30-minute trend, bar-graph and large engineering units, LED Backlight

ACCURACY

±1% of full scale

AMBIENT TEMPERATURE RANGE

-40 – 60 degrees C

TEMPERATURE DRIFT

Less than .1% per degree Celsius over ambient temperature range

POWER SUPPLY

10 - 30 VDC at 10 Watts max

Chapter 3 Installation Instructions

3.1 SENSOR LOCATION

Factors such as air movement, gas density in relation to air, emission sources and environmental variables affect correct sensor location. Air movement by fans, prevailing winds and convection should be carefully evaluated to determine if a leak is more likely to raise gas levels in certain areas within the facility. Vapor density of a gas determines if it will rise or fall in air when there are no significant currents. Lighter than air gases should have the monitors mounted 12 – 18 inches (30 – 45 centimeters) above the potential gas leak and heavier than air gases should be this distance below. Even though the SenSmart 6000 is designed for rugged service, sensors should be protected from environmental damage from water, snow, shock, vibration and dirt.

3.2 MOUNTING THE ENCLOSURE

The SenSmart 6000 standard enclosure is a cast aluminum explosion-proof (NEMA 7) enclosure as shown in Figure 3-1. Figure 3-2 shows dimensions with the dual local sensor head 'Y' adaptor (0010-1200) included. Figure 3-3 shows the dimensions, without the sensor head installed, of the SenSmart 6000's polycarbonate enclosure.

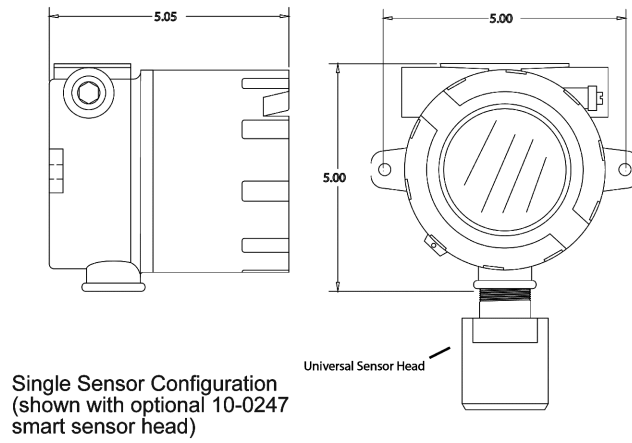

Figure 3-1 SenSmart 6000 Explosion-Proof Housing

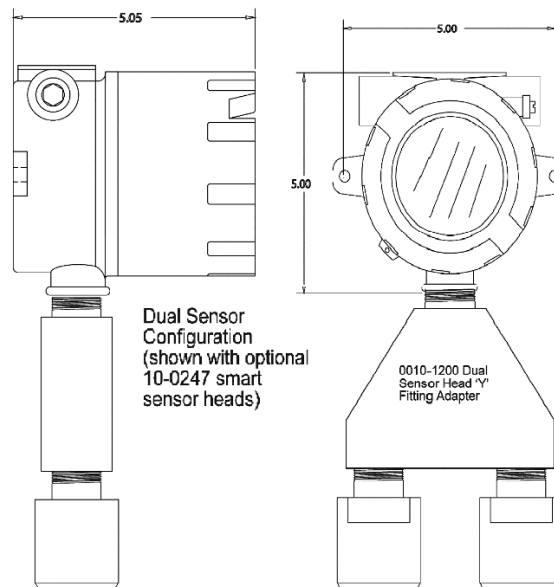

Figure 3-2 SenSmart 6000 Explosion-Proof Housing with Dual Sensor Head Adaptor

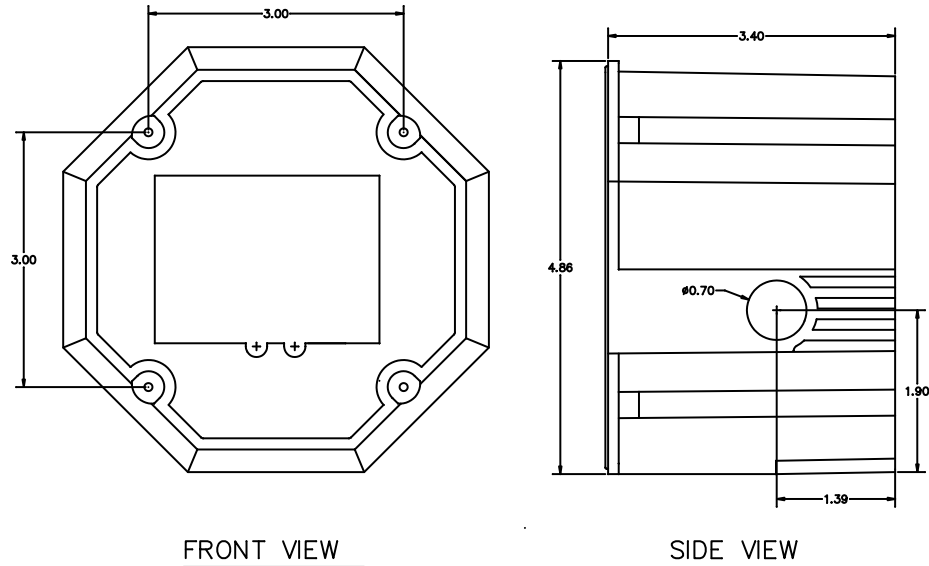

Figure 3-3 SenSmart 6000 Poly Enclosure without Sensor Head

Modular design simplifies the installation of the SenSmart 6000. A top Display Assembly is mounted with captive thumbscrews and is easily removed to access field-wiring terminals. An optional 10-0388 Alarm/RS-485 Modbus board mounts *piggyback* to the back of the Display Assembly. Wiring from simple bridge sensors terminates at the TB2 of the 10-0390 I/O PCB. The bottom 10-0390 I/O Power Supply board generates voltages needed for LCD, relays, RS-485 Modbus, Bridge and Electrochemical Smart Sensor Connections and Simple Bridge sensor.



WARNING: Qualified personnel should perform the installation according to applicable electrical codes, regulations and safety standards. Ensure correct cabling and sealing fitting practices are implemented. Do not aim the sensor pointing upward. Install the SenSmart 6000 to a wall or bracket using the predrilled mounting flanges with I.D. 0.25 on 5 inch centers (Figure 3-2). If conduit is rigid and able to support the weight of the SenSmart 6000, the mounting bolts may be omitted.



CAUTION: The sensor head should never be installed pointing upwards.

3.3 3-WIRE 4-20 MA MODE INSTALLATION

TB2 provides inputs for Channel 1 and Channel 2. By default it is set to provide a Simple Bridge input for Channel 1 and a 4-20mA input for Channel 2. However, a slight board modification will switch Channel 1 from a Simple Bridge input to a 4-20mA input. To switch Channel 1 to a 4-20mA input SB1 and SB2 must have their left pad and center pad connection cut and the center and right pad soldered together. This will provide 24V power to the first (leftmost) terminal of TB2 and a 4-20mA input at the terminal second from the left (Figure 3-4). J4 provides a connection for EC Smart Sensors for Channel 2 inputs. J5 provides a connection for Bridge or EC Smart Sensors for Channel 1 inputs. J3 provides an Ethernet connection for connecting the

SenSmart 6000 to a network. TB1 provides terminals for 24V power input and common. Along with 4-20mA outputs for both Channel 1 and Channel 2.

Instructions: Remove the cover on the SenSmart 6000. Loosen the two thumbscrews holding the display assembly in place and remove it. A 14-pin ribbon cable is attached with sufficient length to allow access to the I/O PCB mounted in the bottom of the enclosure (Figure 3-3). Power and signal connection are to TB1 where 24VDC, Signal and Common wires must be connected. A blocking diode protects the SenSmart 6000 if polarity of the power supply is reversed, but it will not operate. Reassemble the SenSmart 6000. Follow the procedures and recommendations in the receiver and power supply manuals to complete the installation. Be sure the SenSmart 6000 enclosure and conduit are properly grounded. Apply power, and the SenSmart 6000 should function.

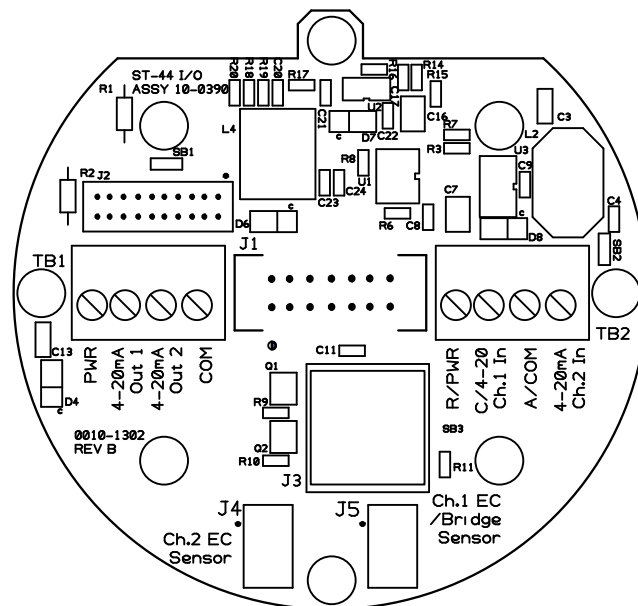

Figure 3-4 10-0390 SenSmart 6000 I/O Power Supply Board

3.4 10-0388 RELAY / RS-485 MODBUS OPTION INSTALLATION

The optional 10-0388 Relay/RS-485 Modbus Option Board supplies three programmable alarm relays, a FAULT relay and two RS-485 Modbus RTU master/slave ports (Figure 3-5). This board is "piggybacked" behind the 10-0387 SenSmart 6000 CPU/Display Board.



Caution: Alarm relays have dry contacts and power must be supplied from an external source. Contacts are rated for RESISTIVE loads! Inductive loads, such as contactor coils or motors, may cause contact arcing. This will shorten life and emit RFI into the sensor signals. Use appropriate arcing snubber and MOVs across inductive loads, and keep wiring away from signal wires. External wiring to TB2 should be shielded and protected from noise spikes to prevent false alarm resets or overrides.

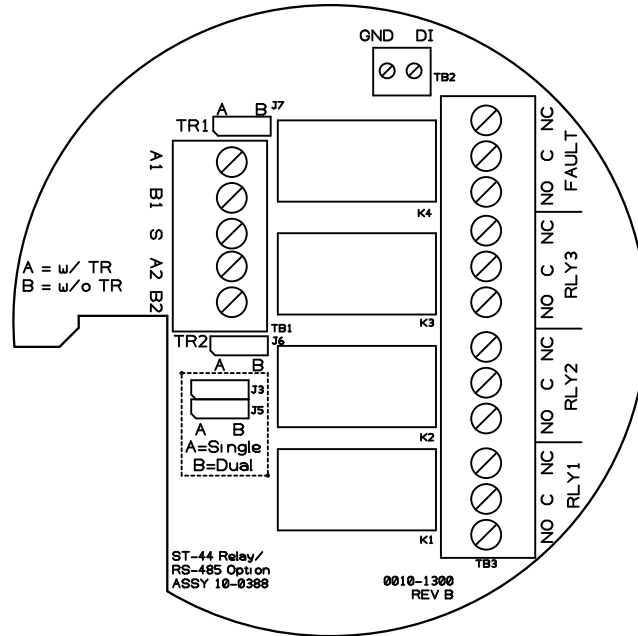

Figure 3-5 10-0388 Relay/RS-485 Option Board

Remove the cover of the SenSmart 6000 enclosure. Loosen the two thumbscrews holding the display assembly in place and remove it. A 14-pin ribbon cable is attached with sufficient length to access the back of the Display assembly where the Alarm/RS-485 Modbus board option is located. It is possible to use only the relays, only RS-485 or both. Relay terminals are labeled NO (Normally Open), NC (Normally Closed) or C (Common, or pole). These designators correspond to the shelf, or de-energized, state of the relays. The FAULT relay is always failsafe. Meaning, it is energized when there is not a fault condition, and therefore its action is reverse of the designators.

RS-485 Modbus networks should be wired as shown in Figure 3-6. Each SenSmart 6000 represents an RTU, and must have a unique Remote ID address. Remote ID addresses are assigned in the Data From Menus discussed in [Section 4.4.1.3](#). Cabling must be a daisy chain as opposed to a star pattern for reliable operation. The "end of line" unit should have J6 and J7 installed in the A position.

With J3 and J5 in the A position, TB1 functions as a Single communication port with A1 tied to A2 and B1 tied to B2. With J3 and J5 in the B position, TB1 functions as a Dual communication port with A1 and B1 being port 1 and A2 and B2 being port 2.

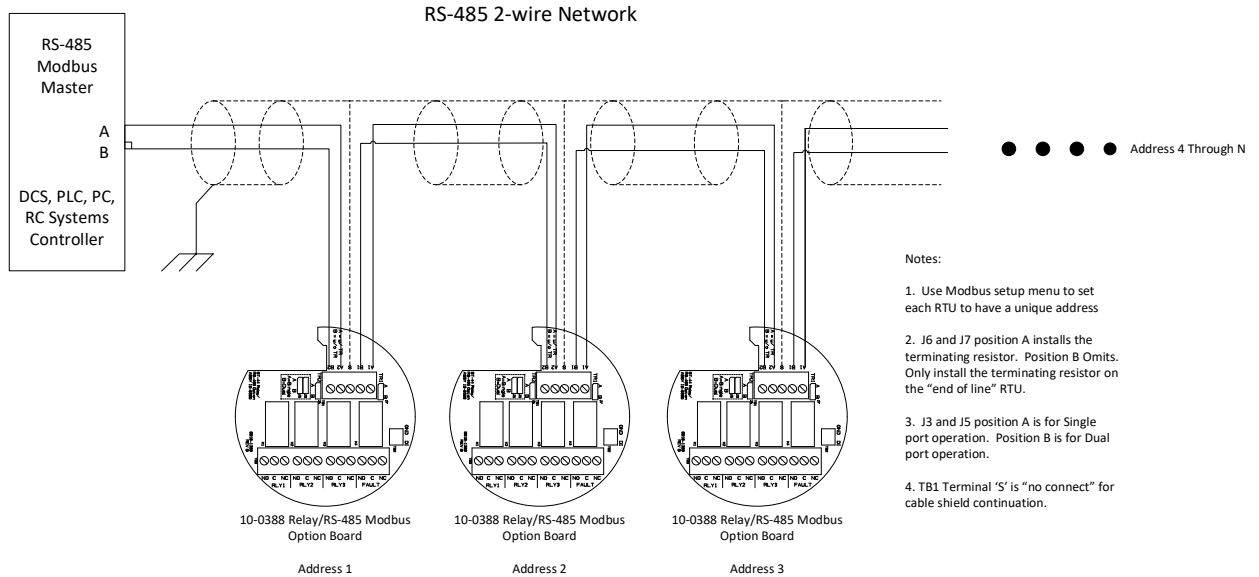

Figure 3-6 RS-485 Modbus Wiring

3.5 SENSOR INSTALLATION

Many manufacturers offer industry standard electrochemical (EC) and catalytic bead sensors for toxic/oxygen and LEL combustible gas detection. These are referred to as simple sensors in this manual. The SenSmart 6000 design accommodates users wishing to continue use of their existing catalytic bead Simple type of sensors, however, EC Simple sensors are not supported. The SenSmart 6000 Smart Sensor interface also uses proven EC technology for toxic/oxygen and catalytic bead for LEL combustibles, but has taken this technology a step further. A tiny memory IC is incorporated into the SenSmart 6000 factory supplied Smart Sensors allowing them to contain the entire database of SenSmart 6000 parameters onboard the replaceable Smart Sensor assembly.

This unique Smart Sensor Interface may be used to configure Smart Sensors and/or SenSmart 6000s from a PC rather than entering all variables via the magnetic key pad.

EC and catalytic bead smart sensors both plug into the 10-0247 Smart Sensor Head, which connects to the SenSmart 6000 with its 8-conductor Smart Sensor Interface cable (Figure 3-7).



Note: 10-0247 Smart Sensor Heads with EC/Oxygen sensors may connect to J4 or J5 on the 10-0309 I/O Board. Bridge Smart sensors can only be connected to J5.

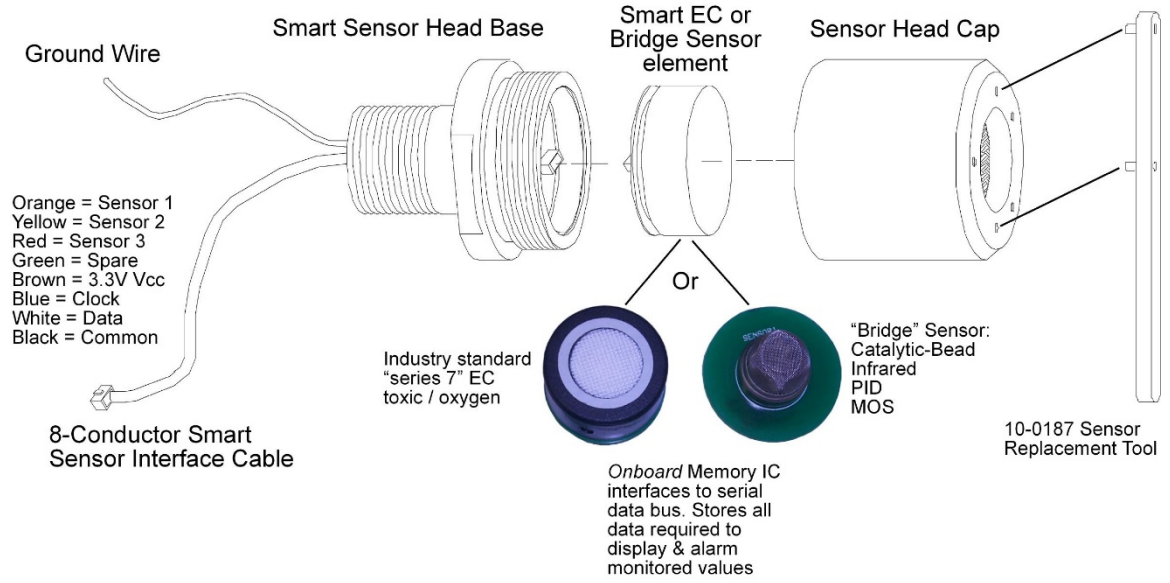

Figure 3-7 10-0247 Smart Sensor Head Assembly

Chapter 4 General Operating Instructions

4.1 INTRODUCTION

Swiping a magnetic wand past the Edit key, from any of the Data Display screens, displays the Main Menu. The Up and Down keys maneuver the selection marker up and down, and Edit selects the highlighted item to enter the sub menus. All items with a submenu are indicated by a right facing arrow at the end of the line. To edit menu item values swipe the Edit key, and use the Up/Down keys to edit the value. Once the desired value is entered, swipe the Edit key again to save the value. Swipe the Next key to reverse out of a submenu.



Important: Some values require a **Technician Sequence** to be entered to change their values. This is to prevent the operator from inadvertently changing the values. When prompted to “Enter technician sequence:” simply swipe the UP key four times to unlock the value for editing.

4.2 ROUTINE SENSOR CALIBRATION

Caution: For calibration of R.C. Systems Inc. Millenium sensors refer to Chapter 7 for calibration procedures. A Zero calibration of the sensor is the only calibration that is required. The transmitter is factory calibrated and does not require routine calibration when using the Millenium sensor.

Calibration is the most important function for ensuring correct operation of the SenSmart 6000. The CAL MODE is designed to make calibration quick, easy and error free. A successful Zero and Span calibration requires only four keystrokes. The 4-20mA output indicates Cal Mode by transmitting the InCal mA as set in [Section 4.4.1.5.8](#) (default of 3mA). It then transmits 4mA during the subsequent Cal Purge Delay as set in [Section 4.7.2.5](#) to prevent external alarms during calibration. Local SenSmart 6000 alarm relays (optional 10-0388 SenSmart 6000 Relay/RS-485 Board) are inhibited during Cal Mode. Cal Mode is exited automatically if no keystrokes are detected after five minutes.

Follow these SenSmart 6000 calibration guidelines:

1. Calibration accuracy is only as good as the calibration **gas** accuracy. R.C. Systems recommends calibration gases with National Institute of Standards and Technology (NIST) traceable accuracy to increase the validity of the calibration.
2. Do not use gas cylinders beyond their expiration date.
3. Calibrate a new sensor before it is put in use.
4. Allow the sensor to stabilize before starting calibration.
5. Calibrate on a regular schedule. R.C. Systems recommends once every 3 months, depending on use and sensor exposure to poisons and contaminants.
6. Calibrate only in a clean atmosphere, free of background gas.

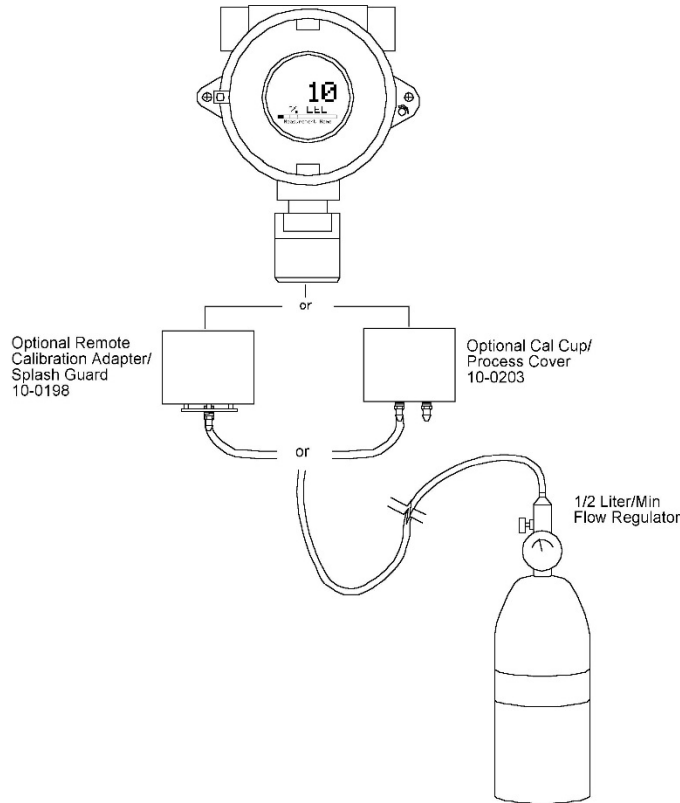

Figure 4-1 Calibration Gas Input

Use the following step-by-step procedure to perform Zero and Span calibrations (Figure 4-2 may be used for reference to the Menus.):



Note: The first three steps must be performed before the timer in the bottom right corner expires, 15 seconds, otherwise the SenSmart 6000 will exit back to the Data Display Screen.

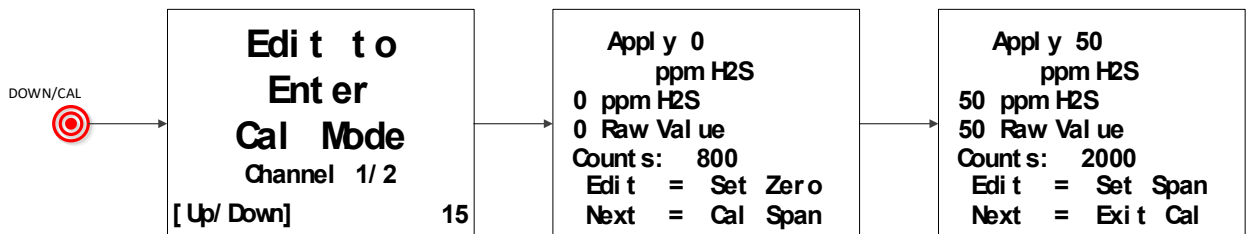

Figure 4-2 Cal Mode Flowchart and Menus

1. Enter Cal mode from any of the Data Display Screens by swiping the DOWN/CAL key.
2. Swipe the Up and/or Down key to select the Channel to be calibrated.



Note: Only channels with Local Cal enabled, per [Section 4.4.1.3](#), will be available for calibration.

3. Swipe the EDIT key to enter Cal Mode.
4. Apply a clean Zero Gas (Figure 4-1), using the Cal Cup, part number 10-0203, or be sure there is no background target gas in the monitored area. After the reading is stable (approximately one minute), swipe the EDIT key to Set the Zero Calibration. To skip the Zero calibration and go to the Span calibration swipe the NEXT key. When a message that the Zero calibration was completed successfully, proceed to the next step.
5. Apply the correct, as indicated, Span gas (Figure 4-1) at 0.5 liters/min. After the reading is stable (approximately one minute), swipe the EDIT key to Set the Span Calibration. To skip the Span Calibration swipe the NEXT key. When a message that the Span calibration was completed successfully, the SenSmart 6000 will exit back to the Data Display Screen.
6. Remove the Cal Gas. Once the Cal Purge Delay ([Section 4.7.2.5](#)) has expired, normal alarm and relay functionality will be restored.

Calibration history records are logged, and may be viewed in the Sensor Information ([Section 4.4.1.3](#)).

4.3 ALARM OUTPUTS

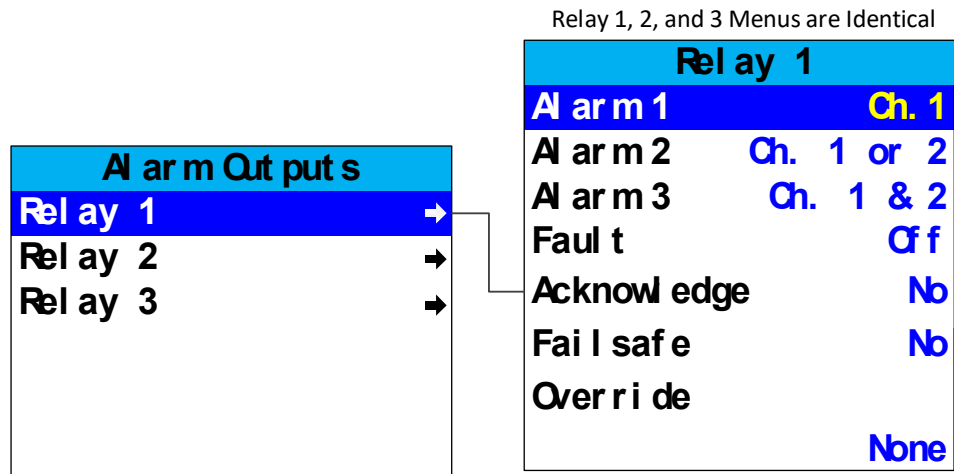

Figure 4-3 Alarm Outputs Menu Tree

The Alarm Outputs Menu is accessed via the Main Menu, and is used to configure the mapping of the three programmable relays to the alarm setpoints, and relay configuration items such as Acknowledge, Failsafe and Override.

The 10-0388 Relay/RS 485 Option Board has three programmable relays and a fourth relay which is dedicated to the Fault alarm.



Note: While these settings only affect relays if the 10-0388 SenSmart 6000 Relay/RS 485 Option Board is installed, the menu options are always available for configuration purposes, regardless as to whether the option board is installed or not.

4.3.1 RELAY 1/2/3

Relay 1, 2, and 3 Menus are Identical

| Relay 1 | |
|-------------|------------|
| Alarm 1 | Ch. 1 |
| Alarm 2 | Ch. 1 or 2 |
| Alarm 3 | Ch. 1 & 2 |
| Fault | Off |
| Acknowledge | No |
| Fail safe | No |
| Override | None |

Figure 4-4 Relay Menu

From this menu, you may select one of the three programmable relays for which you would like to change the settings or mapping.

4.3.1.1 ALARM 1/2/3/FAULT

The Alarm 1, Alarm 2, Alarm 3 and Fault menu items determine the mapping of the relay to each of these alarm setpoints. The selection for each of these four items must all be met simultaneously to activate the relay. Options for each of these items are: Off, Ch.1, Ch.2, Ch.1 & 2, Ch.1 or 2.



Example: If you are in the Relay 1 menu, and have the following settings Alarm 1 set to Ch.1, Alarm 2 set to Ch.1 & 2 and Alarm 3 set to Ch.1 or 2. Relay 1 will energize in the event that the Alarm 1 setpoint for Channel 1 is reached **AND** The Alarm 2 setpoint for BOTH Channel 1 and Channel 2 are reached **AND** the setpoint for Alarm 3 is reached for either Channel 1 or Channel 2.

4.3.1.2 ACKNOWLEDGE

Set to Yes means the UP/RESET key will set the relay to the normal state even if the alarm condition still exists. This is useful for silencing an audible device driven from the relay.

4.3.1.3 FAILSAFE

Set to Yes means the relay de-energizes during alarm and energizes with no alarm. This is useful for signaling an alarm on a loss of power. The dedicated Fault alarm is always Failsafe.

4.3.1.4 OVERRIDE

Override allows the user to have an OR type of condition for energizing/de-energizing a relay. The options are:

1. None
2. Ch1 Alarm 1

3. Ch1 Alarm 2
4. Ch1 Alarm 3
5. Ch1 Fault
6. Ch2 Alarm 1
7. Ch2 Alarm 2
8. Ch2 Alarm 3
9. Ch2 Fault
10. Ch1/2 Cal Zero
11. Ch1 Cal Span
12. Ch2 Cal Span
13. 1/2 Cal Zero/Span

An Override is necessary when you want the relay to trip when either of two different setpoints are reached. For Example, if you want Relay 1 to trip when channel 1 is in Alarm 1 or Fault, you can set the **Alarm 1** setting for Ch1 and set **Override** to Ch1 Fault.

4.4 CHANNEL SETTINGS

The Channel Settings Menu is accessed via the Main Menu.

4.4.1 CHANNEL 1/2

The Channel 1 and Channel 2 Menus are accessed via the Channel Settings Menu.

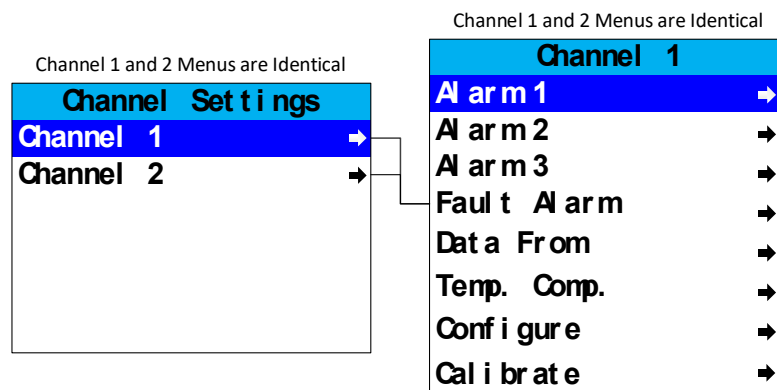

Figure 4-5 Channel 1/2 Menu Tree

4.4.1.1 ALARM 1/2/3

Alarm 1, 2 and 3 Menus may be accessed from the Channel 1 and Channel 2 Menus. Alarm 1 is always enabled and has **Setpoint, Latching, Trip On, On Delay, Off Delay** and **Dead Band** settings. Alarm 2 has the same setting options as Alarm 1, but also adds the **Color** setting. Alarm 3 is the same as Alarm 2, but may be **Enabled** or **Disabled**.

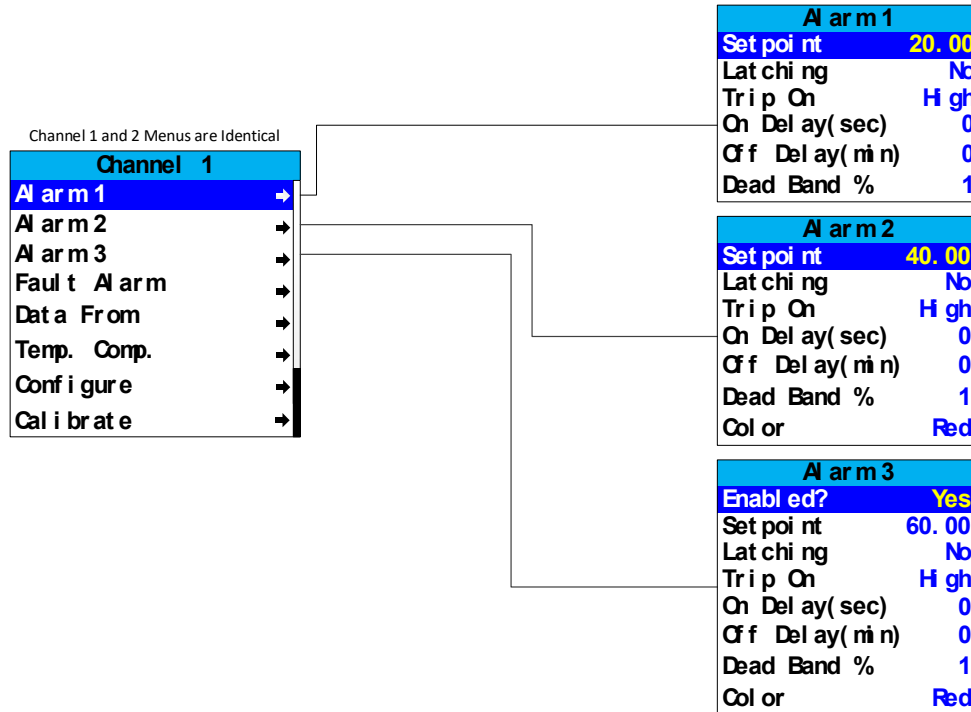

Figure 4-6 Alarm 1/2/3 Menu Tree

4.4.1.1.1 SETPOINT

Setpoint enters the engineering unit value where the alarm will trip. It may be negative and trip when monitored values fall out of range in this direction.

4.4.1.1.2 LATCHING

Setting **Latching** to YES causes the alarm to remain active even after the condition is gone, and to reset only when the UP/RESET key is swiped from a data display.

4.4.1.1.3 TRIP ON

Set **Trip On** to HIGH to have the alarm trip when the value goes above the setpoint. Set to LOW to trip when the value falls below the setpoint.

4.4.1.1.4 ON DELAY(SEC)

On Delay allows entering a maximum 10 second delay before this alarm becomes active. This is useful for preventing spurious alarms by brief spikes beyond the alarm setpoint.

4.4.1.1.5 OFF DELAY(MIN)

Off Delay allows entering a maximum 120 minute delay before clearing an alarm after the alarm condition is gone. This is useful for continuing an alarm function, such as operation of an exhaust fan, for a period of time after the alarm condition clears.

4.4.1.1.6 DEADBAND %

Deadband allows forcing low values to continue to read zero. This is useful when there are small amounts of background gases that cause fluctuating readouts above zero. The highest amount of Deadband allowed is 5%.



Note: Deadband affects **all** outputs as well as the local reading.

4.4.1.1.7 COLOR

Selecting **Color** changes the color associated with the particular alarm. Options are Red, Blue and Orange.



Note: Alarm 1 is always set to Yellow.

4.4.1.2 FAULT ALARM

The **Fault Alarm** is always enabled, and is accessed via the Channel 1 and Channel 2 menus.

4.4.1.2.1 SETPOINT

Fault Alarm has a default setting of negative 10 with Low Trip set for YES. This makes it function as a FAULT alarm and trip when the monitored value falls to less than negative 10. It is important to adjust this value when the transmitter's span value is set for another value other than 100. For example, a typical span setting for monitoring oxygen level is 25 therefore the fault level value should be adjusted to -2.5 which is equal to negative 10% of full scale.

4.4.1.3 DATA FROM



Important: The SenSmart 6000 will only search for an installed sensor of the type set up for that channel. E.g. If **Data From** is set to Bridge Sensor, and a sensor of type EC is installed, the SenSmart 6000 will not load the sensor and it will not be found until **Data From** is changed to EC Sensor.

4.4.1.3.1 EC SENSOR

| Data From | |
|-----------------|-------|
| EC Sensor | |
| Remote Sensor | No |
| Min Raw | 800 |
| Max Raw | 4000 |
| Filter (second) | 20 |
| Polarity | NEG |
| PGA Gain | → |
| Heater Enabled | No |
| Heat (degC) | 25.00 |
| Local Cal | Yes |

Figure 4-7 Data from EC Sensor Menu

4.4.1.3.1.1 Remote Sensor

Enable **Remote Sensor** when using the optional Remote Sensor Board 10-2080, see [Section 5.4](#).

When enabled, two additional menu items appear for Remote ID and Interface. Remote ID matches the Remote ID of the Remote Sensor Board and is set between 1 and 247. Interface indicates which of the two COM ports are being used for that channel.



Note: In order to use the 10-2080 Remote Sensor Board, the SenSmart 6000 must have a 10-0388 Relay/ RS-485 Option board installed.

4.4.1.3.1.2 *Min Raw*

Min Raw defines the minimum range of input counts that provide Measurement Range read-out values. This menu entry is determined by the A/D converter resolution of the channel's input. For example, if the input is 0 at 800 then Min Raw should be set to 800.

If the input device's resolution is unknown, the live counts variable on the Analog inputs menu displays actual raw A/D counts currently being read by this channel. This reading may be used to test the input device for what A/D counts are provided for zero. Forcing the input device to read zero should provide the A/D counts value needed to make this channel's display also read zero.

4.4.1.3.1.3 *Max Raw*

Max Raw defines the maximum range of input counts that provide Measurement Range read-out values. This menu entry is determined by the A/D converter resolution of the channel's input. For example, if the input is 100% at 4000 then Max Raw should be set to 4000.

If the input device's resolution is unknown, the live counts variable on the Analog inputs menu displays actual raw A/D counts currently being read by this channel. This reading may be used to test the input device for what A/D counts are provided for 100%. Forcing the input device to read 100% should provide the A/D counts value needed to make this channel's display also read 100%.

4.4.1.3.1.4 *Filter (second)*

The **Filter** setting sets the number of seconds over which samples are averaged. This may be set from 0 to 60 seconds. If a channel has a noisy input the time may be increased to filter out some of the noise by averaging it over a longer period of time. This causes the reading to react slower to a change in input.

4.4.1.3.1.5 *Polarity*

Polarity sets the polarity of the sensor POS for positive and NEG for negative.

4.4.1.3.1.6 *PGA Gain*

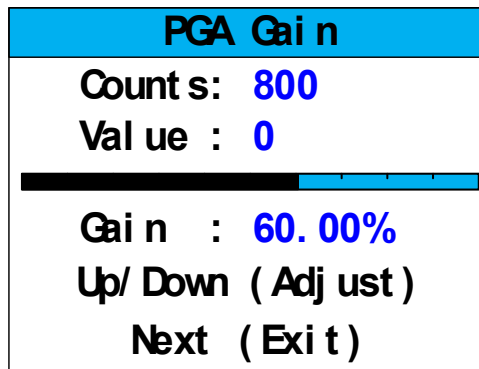

Figure 4-8 PGA Gain Menu

Depending upon the input type, SenSmart 6000 inputs range from a few micro amps to hundreds of micro amps. **PGA Gain** is the adjustment that matches the input signal range to the SenSmart 6000 input signal conditioning circuits. Altering the PGA Gain setting automatically resets previous calibration Offset and Gain values to Unit.

If it is determined the PGA Gain value is incorrect, apply the desired up-scale input and use the UP/DOWN keys to obtain the correct Value. Counts are the binary A/D value.



Caution: For standard installations, this is a factory adjustment. Do not use the PGA Gain menu for calibrating sensors. It should only be adjusted if a new measurement gas or input range is required.

4.4.1.3.1.7 *Heater Enabled*

Heater Enabled enables the locally mounted heater/ temperature controller circuit on the EC Sensor Amplifier Series 7 board 10-0415 and the Series 4 board 10-0381.



Note: This feature should only be used in low temperature environments.

4.4.1.3.1.8 *Heat (degC)*

The **Heat** setting indicates the minimum temperature at which the temperature controller circuit will energize the heater if enabled. It may be set from -25 to 25C.



Note: The Heater function should only be enabled in low temperature environments.

4.4.1.3.1.9 *Local cal*

Local Cal allows the sensor to be calibrated locally from the SenSmart 6000. To configure the Calibration Settings refer to [Section 4.4.1.6](#). For information on how to perform sensor calibration refer to [Section 4.2](#).

4.4.1.3.1.10 *View Sensor Info*

| Ch. 1/ 2 Sensor | |
|-----------------|----------------|
| Type: | ppm H2S |
| Zero: | 0 |
| Span: | 100 |
| SN: | XXXXXXXXXXXXXX |
| Born on: | 12/ 12/ 12 |
| Last cal : | 12/ 12/ 12 |

Figure 4-9 Sensor Information Screen

Sensor Info includes the sensor's Type, Zero and Span values, Serial Number, Born on Date and the Date when the last Calibration was performed.

4.4.1.3.2 BRIDGE SENSOR

| Data From | |
|-----------------|------|
| Bridge Sensor | |
| Remote Sensor | No |
| Min Raw | 800 |
| Max Raw | 4000 |
| Filter (second) | 20 |
| PGA Gain | → |
| Bridge Volts | → |
| Balance | → |
| Local cal | Yes |

Figure 4-10 Data from Bridge Sensor Menu

4.4.1.3.2.1 *Remote Sensor*

Enable **Remote Sensor** when using the optional Remote Sensor Board 10-2080, see [Section 5.4](#).

When enabled, two additional menu items appear for Remote ID and Interface. Remote ID matches the Remote ID of the Remote Sensor Board and is set between 1 and 247. Interface indicates which of the two COM ports are being used for that channel.



Note: In order to use the 10-2080 Remote Sensor Board, the SenSmart 6000 must have a 10-0388 Relay/ RS-485 Option board installed.

4.4.1.3.2.2 *Min Raw*

Min Raw defines the minimum range of input counts that provide Measurement Range read-out values. This menu entry is determined by the A/D converter resolution of the channel's input. For example, if the input is 0 at 800 then Min Raw should be set to 800.

If the input device's resolution is unknown, the live counts variable on the Analog inputs menu displays actual raw A/D counts currently being read by this channel. This reading may be used to test the input device for what A/D counts are provided for zero. Forcing the input device to read zero should provide the A/D counts value needed to make this channel's display also read zero.

4.4.1.3.2.3 *Max Raw*

Max Raw defines the maximum range of input counts that provide Measurement Range read-out values. This menu entry is determined by the A/D converter resolution of the channel's input. For example, if the input is 100% at 4000 then Max Raw should be set to 4000.

If the input device's resolution is unknown, the live counts variable on the Analog inputs menu displays actual raw A/D counts currently being read by this channel. This reading may be used to test the input device for what A/D counts are provided for 100%. Forcing the input device to read 100% should provide the A/D counts value needed to make this channel's display also read 100%.

4.4.1.3.2.4 *Filter (second)*

The **Filter** setting sets the number of seconds over which samples are averaged. This may be set from 0 to 60 seconds. If a channel has a noisy input the time may be increased to filter out some of the noise by averaging it over a longer period of time. This causes the reading to react slower to a change in input.

4.4.1.3.2.5 *PGA Gain*

Depending upon the input type, SenSmart 6000 inputs range from a few micro amps to hundreds of micro amps. **PGA Gain** is the adjustment that matches the input signal range to the SenSmart 6000 input signal conditioning circuits. Altering the PGA Gain setting automatically resets previous calibration Offset and Gain values to Unit.

If it is determined the PGA Gain value is incorrect, apply the desired up-scale input and use the UP/DOWN keys to obtain the correct Value. Counts are the binary A/D value.



Caution: For standard installations, this is a factory adjustment. Do not use the PGA Gain menu for calibrating sensors. It should only be adjusted if a new measurement gas or input range is required.

4.4.1.3.2.6 *Bridge Volts*

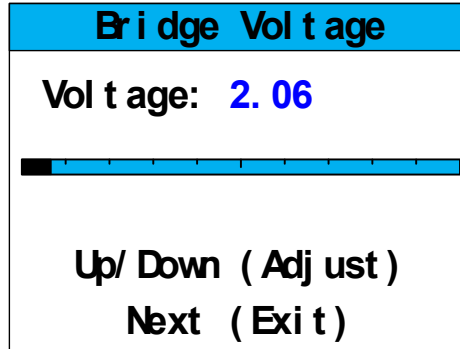

Figure 4-11 Bridge Voltage Adjust Menu

The **Bridge Voltage** is factory configured, and only requires field adjustment if the catalytic bead sensor is mounted remotely from the SenSmart 6000 or if a new sensor is installed. SenSmart 6000 bridge sensors may be from 2 to 6 volts excitation voltage at the sensor. This means, if the sensor is mounted a long distance away, the voltage at the SenSmart 6000 may have to be higher in order to compensate for losses in the field wiring. Be careful not to exceed correct sensor voltage at the sensor's A and R terminals.

4.4.1.3.2.7 *Balance*

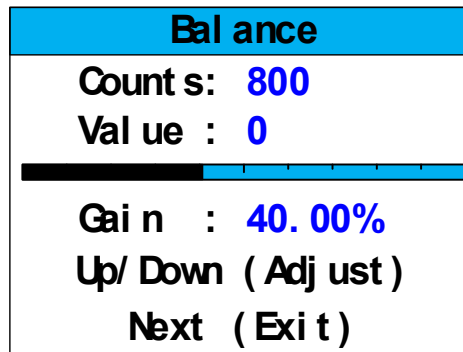

Figure 4-12 Bridge Balance Adjust Menu

The **Bridge Balance** is factory configured, and only requires field adjustment if the catalytic bead sensor is mounted remotely from the SenSmart 6000 or if a new sensor is installed. Balance allows adjusting the balance of the catalytic bead sensor, and must only be performed with ZERO gas on the sensor. Balance is similar to a very coarse ZERO calibration, and does not need to be precise, since subsequent calibrations will correct for small errors. ZERO gas applied to the sensor should provide a reading of -3 to +3 on the Value in the Balance Menu.

4.4.1.3.2.8 *Local Cal*

Local Cal allows the sensor to be calibrated locally from the SenSmart 6000. To configure the Calibration Settings refer to [Section 4.4.1.6](#). For information on how to perform sensor calibration refer to [Section 4.2](#).

4.4.1.3.2.9 View Sensor Info

| Ch. 1/ 2 Sensor | |
|-----------------|----------------|
| Type: | %LEL |
| Zero: | 0 |
| Span: | 100 |
| SN: | XXXXXXXXXXXXXX |
| Born on: | 12/ 12/ 12 |
| Last cal : | 12/ 12/ 12 |

Figure 4-13 Sensor Information Screen

Sensor Info includes the sensor's Type, Zero and Span values, Serial Number, Born on Date and the Date when the last Calibration was performed.

4.4.1.3.3 AI 4-20MA

| Data From | |
|-----------------|-----------|
| | AI 4-20mA |
| Min Raw | 800 |
| Max Raw | 4000 |
| Filter (second) | 5 |
| Local Cal | Yes |
| Marker Menu | → |

Figure 4-14 Data from Analog Input 4-20mA Menu

4.4.1.3.3.1 Min Raw

Min Raw defines the minimum range of input counts that provide Measurement Range read-out values. This menu entry is determined by the A/D converter resolution of the channel's input. For example, if the input is 0 at 800 then Min Raw should be set to 800.

If the input device's resolution is unknown, the live counts variable on the Analog inputs menu displays actual raw A/D counts currently being read by this channel. This reading may be used to test the input device for what A/D counts are provided for zero. Forcing the input device to read zero should provide the A/D counts value needed to make this channel's display also read zero.

4.4.1.3.3.2 Max Raw

Max Raw defines the maximum range of input counts that provide Measurement Range read-out values. This menu entry is determined by the A/D converter resolution of the channel's input. For example, if the input is 100% at 4000 then Max Raw should be set to 4000.

If the input device's resolution is unknown, the live counts variable on the Analog inputs menu displays actual raw A/D counts currently being read by this channel. This reading may be used to test the input device for what A/D counts are provided for 100%. Forcing the input device to

read 100% should provide the A/D counts value needed to make this channel's display also read 100%.

4.4.1.3.3.3 *Filter (second)*

The **Filter** setting sets the number of seconds over which samples are averaged. This may be set from 0 to 60 seconds. If a channel has a noisy input the time may be increased to filter out some of the noise by averaging it over a longer period of time. This causes the reading to react slower to a change in input.

4.4.1.3.3.4 *Local Cal*

When enabled, this allows the sensor to be calibrated locally from the SenSmart 6000. To configure the Calibration settings refer to [Section 4.4.1.6](#). For information on how to perform sensor calibration refer to [Section 4.2](#).

4.4.1.3.3.5 *Marker Menu*

| Marker Menu | |
|----------------|--------|
| Marker Enabled | No |
| Marker % | -15.63 |
| Mark as | IN CAL |
| Sensor Life | NO |

Figure 4-15 Marker Menu

Some monitors indicate special modes of operation such as Calibration or Maintenance by transmitting a special <4mA "Marker" value. The SenSmart 6000 offers a 4-20mA **Marker Menu** for detecting inputs between -20% and 0% that represent such events. Once detected, the SenSmart 6000 transmits a constant mA output equal to the Marker value.



Caution: Since FAULT alarms are also tripped in the < 4mA region it is important to understand that the Marker events override the FAULT alarm.

Selecting Yes in the *Marker Enabled* field activates the Marker. *Marker %* allows entering a value from -20% to 0% with up to three decimal points. *Mark as* allows entry of the up to six digit ASCII message the readout will display when the marker is detected.

Enabling the **Sensor Life** option will allow the SenSmart 6000 to receive sensor life data from the input source after calibration. Ensure the **Mark %** value is equivalent to the **In Cal** mA value for the input source so that it is recognizable as having been calibrated so the sensor life can be read.

4.4.1.3.4 MODBUS 16BIT

| Data From | |
|--------------|-------|
| Modbus 16bit | |
| Min Raw | 800 |
| Max Raw | 4000 |
| Remote ID | 1 |
| Alias | 31001 |
| Interface | COM1 |
| Marker Menu | ➔ |

Figure 4-16 Data from Modbus 16-bit Menu

For additional information on Modbus slave configuration refer to [Chapter 5](#).

4.4.1.3.4.1 *Min Raw*

Min Raw defines the minimum range of input counts that provide Measurement Range read-out values. This menu entry is determined by the A/D converter resolution of the channel's input. For example, if the input is 0 at 800 then Min Raw should be set to 800.

If the input device's resolution is unknown, the live counts variable on the Analog inputs menu displays actual raw A/D counts currently being read by this channel. This reading may be used to test the input device for what A/D counts are provided for zero. Forcing the input device to read zero should provide the A/D counts value needed to make this channel's display also read zero.

4.4.1.3.4.2 *Max Raw*

Max Raw defines the maximum range of input counts that provide Measurement Range read-out values. This menu entry is determined by the A/D converter resolution of the channel's input. For example, if the input is 100% at 4000 then Max Raw should be set to 4000.

If the input device's resolution is unknown, the live counts variable on the Analog inputs menu displays actual raw A/D counts currently being read by this channel. This reading may be used to test the input device for what A/D counts are provided for 100%. Forcing the input device to read 100% should provide the A/D counts value needed to make this channel's display also read 100%.

4.4.1.3.4.3 *Remote ID*

Each device on a Modbus network must have a unique Remote ID. When Data From is set to Modbus, **Remote ID** is where the slave's unique ID number is entered. Remote ID numbers up to 247 are valid.

4.4.1.3.4.4 *Alias*

The **Alias** register numbers define the location of the variable representing the input value of the Modbus data received through the Communications ports. This number must be obtained from the manufacturer of the Modbus RTU device.

4.4.1.3.4.5 *Interface*

The **Interface** assigns what communication port the Modbus slave is connected to and the channel will get its data from. The communication port that is assigned here must be configured as a Modbus Master.

4.4.1.3.4.6 *Marker Menu*

| Marker Menu | |
|-----------------------|---------------|
| Marker Enabled | No |
| Marker % | -15.63 |
| Mark as | IN CAL |
| Sensor Life | NO |

Figure 4-17 Marker Menu

Some monitors indicate special modes of operation such as Calibration or Maintenance by transmitting a special <4mA "Marker" value. The SenSmart 6000 offers a 4-20mA **Marker Menu** for detecting inputs between -20% and 0% that represent such events. Once detected, the SenSmart 6000 transmits a constant mA output equal to the Marker value.



Caution: Since FAULT alarms are also tripped in the < 4mA region it is important to understand that the Marker events override the FAULT alarm.

Selecting Yes in the *Marker Enabled* field activates the Marker. *Marker %* allows entering a value from -20% to 0% with up to three decimal points. *Mark as* allows entry of the up to six digit ASCII message the readout will display when the marker is detected.

Enabling the **Sensor Life** option will allow the SenSmart 6000 to receive sensor life data from the input source after calibration. Ensure the **Mark %** value is equivalent to the **In Cal** mA value for the input source so that it is recognizable as having been calibrated so the sensor life can be read.

4.4.1.3.5 MODBUS 16 SIGNED

| Data From | |
|------------------|-------|
| Modbus 16 Signed | |
| Min Raw | 800 |
| Max Raw | 4000 |
| Remote ID | 1 |
| Alias | 31001 |
| Interface | COM1 |
| Marker Menu | → |

Figure 4-18 Data from Modbus 16-bit Signed Menu

For additional information on Modbus slave configuration refer to [Chapter 5](#).

4.4.1.3.5.1 *Min Raw*

Min Raw defines the minimum range of input counts that provide Measurement Range read-out values. This menu entry is determined by the A/D converter resolution of the channel's input. For example, if the input is 0 at 800 then Min Raw should be set to 800.

If the input device's resolution is unknown, the live counts variable on the Analog inputs menu displays actual raw A/D counts currently being read by this channel. This reading may be used to test the input device for what A/D counts are provided for zero. Forcing the input device to read zero should provide the A/D counts value needed to make this channel's display also read zero.

4.4.1.3.5.2 *Max Raw*

Max Raw defines the maximum range of input counts that provide Measurement Range read-out values. This menu entry is determined by the A/D converter resolution of the channel's input. For example, if the input is 100% at 4000 then Max Raw should be set to 4000.

If the input device's resolution is unknown, the live counts variable on the Analog inputs menu displays actual raw A/D counts currently being read by this channel. This reading may be used to test the input device for what A/D counts are provided for 100%. Forcing the input device to read 100% should provide the A/D counts value needed to make this channel's display also read 100%.

4.4.1.3.5.3 *Remote ID*

Each device on a Modbus network must have a unique Remote ID. When Data From is set to Modbus, **Remote ID** is where the slave's unique ID number is entered. Remote ID numbers up to 247 are valid.

4.4.1.3.5.4 *Alias*

The **Alias** register numbers define the location of the variable representing the input value of the Modbus data received through the Communications ports. This number must be obtained from the manufacturer of the Modbus RTU device.

4.4.1.3.5.5 *Interface*

The **Interface** assigns what communication port the Modbus slave is connected to and the channel will get its data from. The communication port that is assigned here must be configured as a Modbus Master.

4.4.1.3.5.6 *Marker Menu*

| Marker Menu | |
|----------------|--------|
| Marker Enabled | No |
| Marker % | -15.63 |
| Mark as | IN CAL |
| Sensor Life | NO |

Figure 4-19 Marker Menu

Some monitors indicate special modes of operation such as Calibration or Maintenance by transmitting a special <4mA "Marker" value. The SenSmart 6000 offers a 4-20mA **Marker Menu** for detecting inputs between -20% and 0% that represent such events. Once detected, the SenSmart 6000 transmits a constant mA output equal to the Marker value.



Caution: Since FAULT alarms are also tripped in the < 4mA region it is important to understand that the Marker events override the FAULT alarm.

Selecting Yes in the *Marker Enabled* field activates the Marker. *Marker %* allows entering a value from -20% to 0% with up to three decimal points. *Mark as* allows entry of the up to six digit ASCII message the readout will display when the marker is detected.

Enabling the **Sensor Life** option will allow the SenSmart 6000 to receive sensor life data from the input source after calibration. Ensure the **Mark %** value is equivalent to the **In Cal** mA value for the input source so that it is recognizable as having been calibrated so the sensor life can be read.

4.4.1.3.6 MODBUS 32BIT

| Data From | |
|--------------|-------|
| Modbus 32bit | |
| Remote ID | 1 |
| Alias | 31001 |
| Interface | COM1 |
| Byte Order | BADC |
| Marker Menu | ➔ |

Figure 4-20 Data from Modbus 32-bit Menu

For additional information on Modbus slave configuration refer to [Chapter 5](#).

4.4.1.3.6.1 *Remote ID*

Each device on a Modbus network must have a unique Remote ID. When Data From is set to Modbus, **Remote ID** is where the slave's unique ID number is entered. Remote ID numbers up to 247 are valid.

4.4.1.3.6.2 *Alias*

The **Alias** register numbers define the location of the variable representing the input value of the Modbus data received through the Communications ports. This number must be obtained from the manufacturer of the Modbus RTU device.

4.4.1.3.6.3 *Interface*

The **Interface** assigns what communication port the Modbus slave is connected to and the channel will get its data from. The communication port that is assigned here must be configured as a Modbus Master.

4.4.1.3.6.4 *Byte Order*

Byte Order determines WORD and BYTE alignment of data at the remote Modbus transmitter when sending its 4 byte IEEE Floating Point values. With the selection bar on this entry, swipe the Edit key to toggle between the four possible modes. The default setting is BADC.

4.4.1.3.6.5 *Marker Menu*

| Marker Menu | |
|----------------|--------|
| Marker Enabled | No |
| Marker % | -15.63 |
| Mark as | IN CAL |
| Sensor Life | NO |

Figure 4-21 Marker Menu

Some monitors indicate special modes of operation such as Calibration or Maintenance by transmitting a special <4mA "Marker" value. The SenSmart 6000 offers a 4-20mA **Marker Menu** for detecting inputs between -20% and 0% that represent such events. Once detected, the SenSmart 6000 transmits a constant mA output equal to the Marker value.



Caution: Since FAULT alarms are also tripped in the < 4mA region it is important to understand that the Marker events override the FAULT alarm.

Selecting Yes in the *Marker Enabled* field activates the Marker. *Marker %* allows entering a value from -20% to 0% with up to three decimal points. *Mark as* allows entry of the up to six digit ASCII message the readout will display when the marker is detected.

Enabling the **Sensor Life** option will allow the SenSmart 6000 to receive sensor life data from the input source after calibration. Ensure the **Mark %** value is equivalent to the **In Cal** mA value for the input source so that it is recognizable as having been calibrated so the sensor life can be read.

4.4.1.3.7 LOW POWER IR

| Data From | |
|-----------------|------|
| Low Power I R | |
| Remote Sensor | No |
| Min Raw | 800 |
| Max Raw | 4000 |
| Filter (second) | 20 |

Figure 4-22 Data from Bridge Sensor Menu

4.4.1.3.7.1 Remote Sensor

Enable **Remote Sensor** when using the optional Remote Sensor Board 10-2080, see [Section 5.4](#).

When enabled, two additional menu items appear for Remote ID and Interface. Remote ID matches the Remote ID of the Remote Sensor Board and is set between 1 and 247. Interface indicates which of the two COM ports are being used for that channel.

Note: In order to use the 10-2080 Remote Sensor Board, the SenSmart 6000 must have a 10-0388 Relay/ RS-485 Option board installed.

4.4.1.3.7.2 Min Raw

Min Raw defines the minimum range of input counts that provide Measurement Range read-out values. This menu entry is determined by the A/D converter resolution of the channel's input. For example, if the input is 0 at 800 then Min Raw should be set to 800.

If the input device's resolution is unknown, the live counts variable on the Analog inputs menu displays actual raw A/D counts currently being read by this channel. This reading may be used to test the input device for what A/D counts are provided for zero. Forcing the input device to read zero should provide the A/D counts value needed to make this channel's display also read zero.

4.4.1.3.7.3 Max Raw

Max Raw defines the maximum range of input counts that provide Measurement Range read-out values. This menu entry is determined by the A/D converter resolution of the channel's input. For example, if the input is 100% at 4000 then Max Raw should be set to 4000.

If the input device's resolution is unknown, the live counts variable on the Analog inputs menu displays actual raw A/D counts currently being read by this channel. This reading may be used to test the input device for what A/D counts are provided for 100%. Forcing the input device to read 100% should provide the A/D counts value needed to make this channel's display also read 100%.

4.4.1.3.7.4 *Filter (second)*

The **Filter** setting sets the number of seconds over which samples are averaged. This may be set from 0 to 60 seconds. If a channel has a noisy input the time may be increased to filter out some of the noise by averaging it over a longer period of time. This causes the reading to react slower to a change in input.

4.4.1.4 *TEMP. COMP.*

| Temp. Comp. | | |
|-------------|------|--------|
| Temp | Gain | Offset |
| -40 | 1.00 | +0.00 |
| -30 | 1.00 | +0.00 |
| -20 | 1.00 | +0.00 |
| -10 | 1.00 | +0.00 |
| 0 | 1.00 | +0.00 |
| 10 | 1.00 | +0.00 |
| 20 | 1.00 | +0.00 |
| 30 | 1.00 | +0.00 |
| 40 | 1.00 | +0.00 |
| 50 | 1.00 | +0.00 |
| 60 | 1.00 | +0.00 |

Figure 4-23 Temperature Compensation Menu

Temperature Compensation allows the user to adjust the gain and offset that is applied to sensors to compensate for temperature drift. Factory supplied sensors are preprogrammed with these values which are automatically uploaded to the SenSmart 6000 from the smart sensor. The default values are 1.000 for gain and 0.000 for offset. With these default values entered, there is no extra gain or offset applied to the sensor. This menu is not accessible unless a smart sensor, which is equipped with the temperature sensor, is installed. From this menu, you can adjust the gain and offset applied to the sensor at 10C increments from -40 to 60C. The gain is applied to the span value, and the offset is adjusted to make the sensor read zero at different temperatures.

4.4.1.5 CONFIGURE

| Configure | |
|-----------------|--------|
| Measurement | Name |
| E Unit | PCTLEL |
| Zero | 0.00 |
| Span | 100.00 |
| Decimal Points | 0 |
| Channel On? | Yes |
| Deadband (%) | 1.00 |
| InCal mA | 3.00 |
| Backup/ Restore | → |

Figure 4-24 Channel Configuration Menu

4.4.1.5.1 MEASUREMENT NAME

Measurement Name may be edited to contain virtually any 16 character ASCII field. It is typically used to describe the monitored point by user tag number or other familiar terminology.

4.4.1.5.2 E.UNIT

Engineering Units (EUNIT) may have up to a 10 character ASCII field. Many common gases have preconfigured EUNITs based upon the sensor type, and each may be edited in this menu.

4.4.1.5.3 ZERO

Zero defines the reading to be displayed when 4mA (0%) is the SenSmart 6000 output.

4.4.1.5.4 SPAN

Span defines the reading to be displayed when 20mA (100%) is the SenSmart 6000 output. The highest reading allowed is 9999 and include a polarity sign and a decimal point.

4.4.1.5.5 DECIMAL POINTS

Decimal Points sets the resolution of the displayed reading and may be set to zero, one or two decimal points.

4.4.1.5.6 CHANNEL ON?

Channel ON determines whether or not the channel is active and being used.

4.4.1.5.7 DEADBAND (%)

Deadband allows forcing low values to continue to read zero. This is useful when there are small amounts of background gases that cause fluctuating readouts above zero. The highest amount of Deadband allowed is 5%. **Note:** Deadband affects **all** outputs as well as the local reading.

4.4.1.5.8 INCAL MA

InCal mA determines the output when the channel is in Calibration mode. It may be set from 0 to 20mA. This signal may be used by the controller to determine that the unit is in calibration.

4.4.1.5.9 BACKUP/RESTORE

| Backup/ Restore | |
|--------------------|---|
| Copy To Ch. 2 | ➔ |
| Restore Defaults | ➔ |
| Save Backup | ➔ |
| Restore Backup | ➔ |
| Upload From Sensor | ➔ |
| Sensor factory def | ➔ |

Figure 4-25 Configuration Backup/Restore Menu

The **Backup/Restore Menu** allows you to perform many operations dealing with the configuration of the SenSmart 6000. Selecting *Copy To Ch.1/Ch.2* will copy the current channel's configuration to the other channel. *Restore Defaults* sets all configuration data back to factory defaults. *Save Backup* saves a copy of the configuration to non-volatile memory for restoration at a later time. *Restore Backup* will restore the configuration to the last saved Backup. *Upload From Sensor* will upload the sensor configuration data to the SenSmart 6000. *Sensor factory def* restores the configuration to the original factory defaults stored within the sensor's read only memory.

4.4.1.6 CALIBRATE

| Calibrate | |
|----------------|-------|
| Offset | 0.00 |
| Gain | 1.00 |
| Cal Zero | 0.00 |
| Cal Span | 50.00 |
| Set Unity Gain | ➔ |

Figure 4-26 Channel Calibration Menu

The **Calibrate Menu** shows the settings for calibration. It will display any Offset or Gain currently applied, and allows you to enter the values for the zero and span gases that will be used during calibration. You may also reset the gain back to unity by selecting *Set Unity Gain*.

4.5 COMM SETTINGS

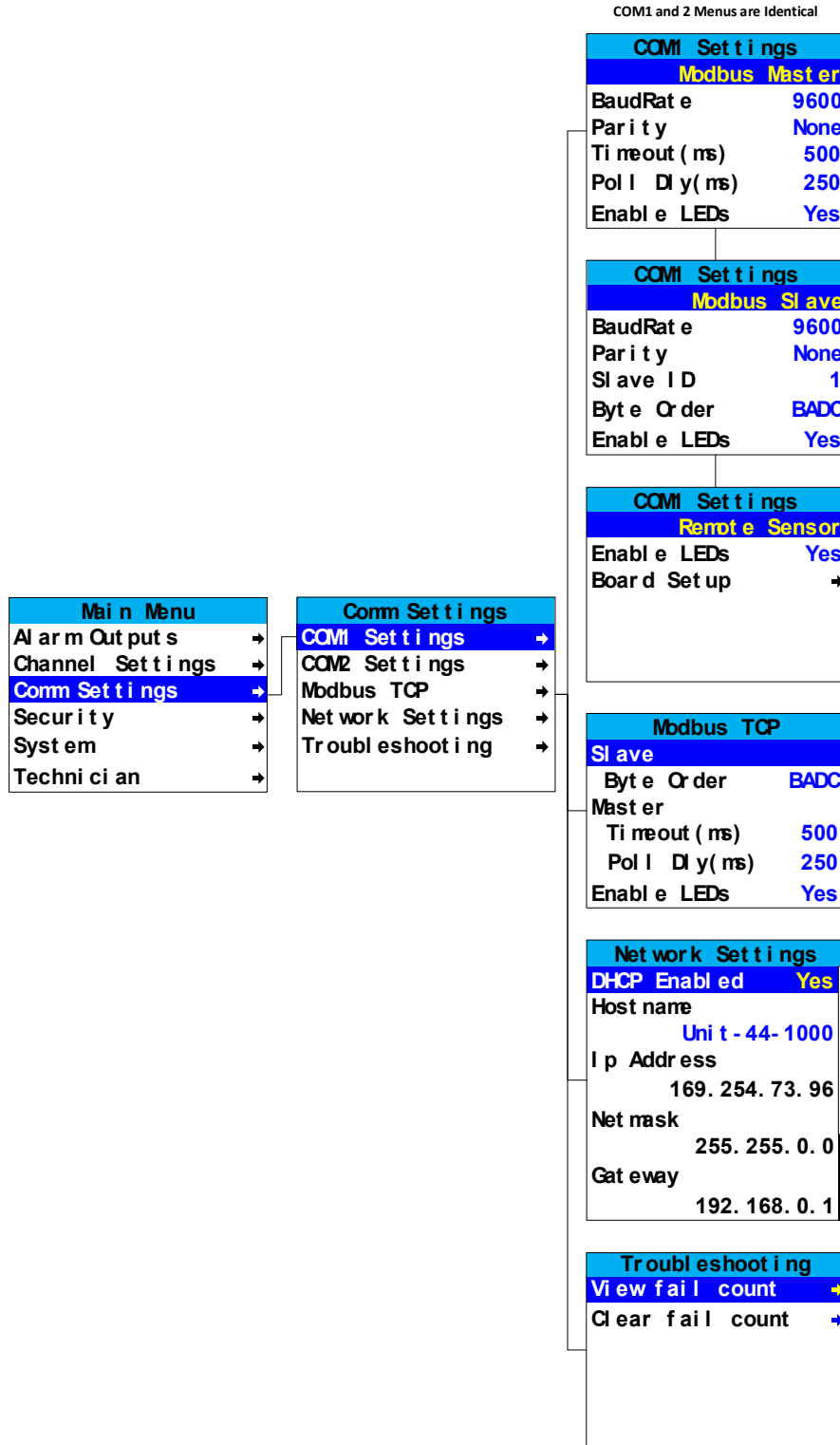

Figure 4-27 Comm Settings Menu Tree

Comm Settings Menu is accessed through the Main Menu. This menu is used to configure the two possible communication ports on the optional 10-0388 Relay/RS-485 Modbus Option Board.

4.5.1 COM1/COM2 SETTINGS

COM1 and COM2 Menus are Identical

| COM1 Settings | | COM1 Settings | | COM1 Settings | |
|---------------|------|---------------|------|---------------|-----|
| Modbus Master | | Modbus Slave | | Remote Sensor | |
| BaudRate | 9600 | BaudRate | 9600 | Enable LEDs | Yes |
| Parity | None | Parity | None | Board Setup | |
| Timeout (ms) | 500 | Slave ID | 1 | | |
| Poll Dly (ms) | 250 | Byte Order | BADC | | |
| Enable LEDs | Yes | Enable LEDs | Yes | | |

Figure 4-28 COM1 and COM2 Settings Menu

The function parameter allows the communication ports to be set to **Modbus Master**, **Modbus Slave**, **Remote Sensor** or **Disabled**.

Modbus Master Mode allows the communication port to poll any device using the Modbus RTU protocol.

Modbus Slave Mode allows the communication port to be polled by any Modbus Master device using the Modbus RTU protocol.

Remote Sensor allows communication with the 10-2080 Remote Sensor Option Board. For more information on how to configure COM1 and COM2 for Remote Sensor operation, refer to [Section 6.4](#).

Select **Disabled** to turn the port off if not needed.

4.5.1.1 BAUDRATE

Baudrate allows users to set the data rate of the communication port. The options include 9600, 19200, 38400, 57600 and 115200.

4.5.1.2 PARITY

A **Parity** bit is a bit that is added to ensure that the number of bits with the value "1" in a set of bits is even or odd. Parity bits are used as the simplest form of error detecting within code. The default is **None**.

4.5.1.3 TIMEOUT (MS)

The **Timeout** menu item affects the SenSmart 6000's *Master* Modbus ports. **Timeout** is the length of time, in milliseconds, the controller waits before a Modbus request fails. Three consecutive failed requests must occur before a communication error is indicated. This item is useful for optimizing throughput to the SenSmart 6000 from other slave RTUs.

4.5.1.4 POLL DLY (MS)

Poll Dly is the time in milliseconds the unit will delay between Modbus master requests.

4.5.1.5 BYTE ORDER

Byte Order determines WORD and BYTE alignment of data at the remote Modbus transmitter when sending its 4 byte IEEE Floating Point values. Selecting this value cycles through four options ABCD, CDAB, BADC (default) and DCBA.

4.5.1.6 ENABLE LEDs

Enable LEDs enables the RX and TX LEDs to flash green on valid transmit and receive transmissions. For ports configured as master, the RX LED will flash red if there is a Comm Error or if an exception is received. Slave ports will cause the RX LED to flash red under the same conditions, but can also cause the TX LED to flash red if an invalid function code is received or if the wrong register is given.



Caution: When using the LEDs to assist with troubleshooting it is important to note that LEDs may be enabled via Comm Port settings and Modbus TCP settings. So it is important to disable the LEDs for the ports which are not being tested.

4.5.1.7 SLAVE ID

Slave ID is set to uniquely identify an SenSmart 6000 in Modbus Slave mode. May be set to any value 1-247.

4.5.2 MODBUS TCP

| Modbus TCP | |
|-----------------|------|
| Slave | |
| Byte Order | BADC |
| Master | |
| Timeout (ms) | 500 |
| Poll Delay (ms) | 250 |
| Enable LEDs | Yes |

Figure 4-29 Modbus TCP Menu

4.5.2.1 SLAVE BYTE ORDER

If Modbus Slave is selected, **Slave Byte Order** determines WORD and BYTE alignment of data at the remote Modbus transmitter when sending its 4 byte IEEE Floating Point values. With the select bar on this entry, swiping the EDIT key toggles between the 4 possible modes. Min/Max Raw values are not used in this mode. Default is set to BADC.

4.5.2.2 MASTER TIMEOUT (MS)

Master Timeout is the time in milliseconds before the unit gives up on a Modbus request and moves on to the next channel. After three consecutive timeouts, the channel enters the COM Error state.

4.5.2.3 MASTER POLL DLY (MS)

Master Poll Dly is the time in milliseconds the unit will delay between Modbus Master requests.

4.5.2.4 ENABLE LEDs

Enable LEDs enables the RX and TX LEDs to flash green on valid transmit and receive transmissions. For ports configured as master, the RX LED will flash red if there is a Comm Error or if an exception is received. Slave ports will cause the RX LED to flash red under the same conditions, but can also cause the TX LED to flash red if an invalid function code is received or if the wrong register is given.



Caution: When using the LEDs to assist with troubleshooting it is important to note that LEDs may be enabled via Comm Port settings and Modbus TCP settings. So it is important to disable the LEDs for the ports which are not being tested.

4.5.3 NETWORK SETTINGS

| Network Settings | |
|------------------|------------------|
| DHCP Enabled | Yes |
| Host name | Unit - 44- 1000 |
| Ip Address | 169. 254. 73. 96 |
| Net mask | 255. 255. 0. 0 |
| Gateway | 192. 168. 0. 1 |

Figure 4-30 Network Settings Menu

See [Section 6.2](#) for integrating a SenSmart 6000 into a network.

4.5.3.1 DHCP ENABLED

DHCP Enabled allows the IP address to be set automatically by an external DHCP server. When this parameter is enabled, the unit can be accessed by its hostname or IP address. However, the IP address will be dependent on the DHCP server, and could potentially change.

4.5.3.2 HOSTNAME

Hostname identifies the SenSmart 6000 on a network as an alternative to the IP address.

4.5.3.3 IP ADDRESS

IP Address identifies the SenSmart 6000 on a network. This is automatically set when DHCP is enabled.

4.5.3.4 NETMASK

Specify if your network requires. **Netmask** specifies the subnet addressing scheme. This is automatically set when DHCP is enabled.

4.5.3.5 GATEWAY

Gateway is the IP address of the device that may connect this subnet to other networks. This is automatically set when DHCP is enabled.

4.5.4 TROUBLESHOOTING

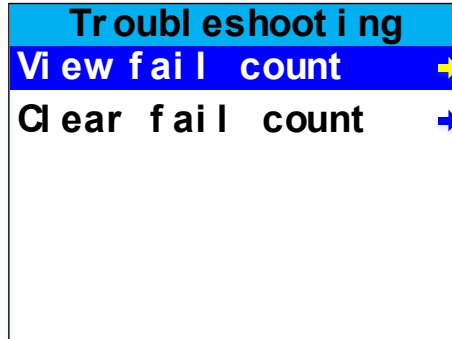

Figure 4-31 Troubleshooting Menu

The Troubleshooting Menu may be used to observe communication issues during serial communication.

4.5.4.1 VIEW FAIL COUNT

View the number of failed communication attempts when using serial communications.

4.5.4.2 CLEAR FAIL COUNT

Clear the fail count to reset the value to zero.

4.6 SECURITY

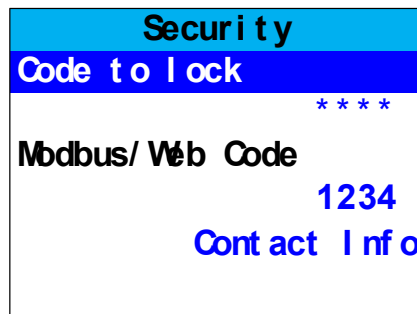

Figure 4-32 Security Menu

The **Security Menu** offers the ability to lock the SenSmart 6000 using a four digit Code. Once enabled, the only actions that may be taken are to view the menus, view the data displays and perform calibrations. No fields may be edited without entering the Code to unlock in the Security Menu.

To enable the Security Mode, enter a four digit Code.



Note: This is a one-time use code, which will be used to unlock the unit at a later time. Re-enter the Code to confirm and the SenSmart 6000 will lock.

To disable the Security Mode, enter the four digit Code entered previously in the Security Menu.

The Modbus/Web Code is used on the embedded webpage to provide security by preventing inadvertent manipulation of the configuration from the webpage (See [Section 6.1](#)).

The Contact Info field is a 16 character ASCII field available for displaying a phone number or name of personnel who know the Code. Lost codes may be recovered by entering the locked security menu and entering the code 8621.

4.7 SYSTEM

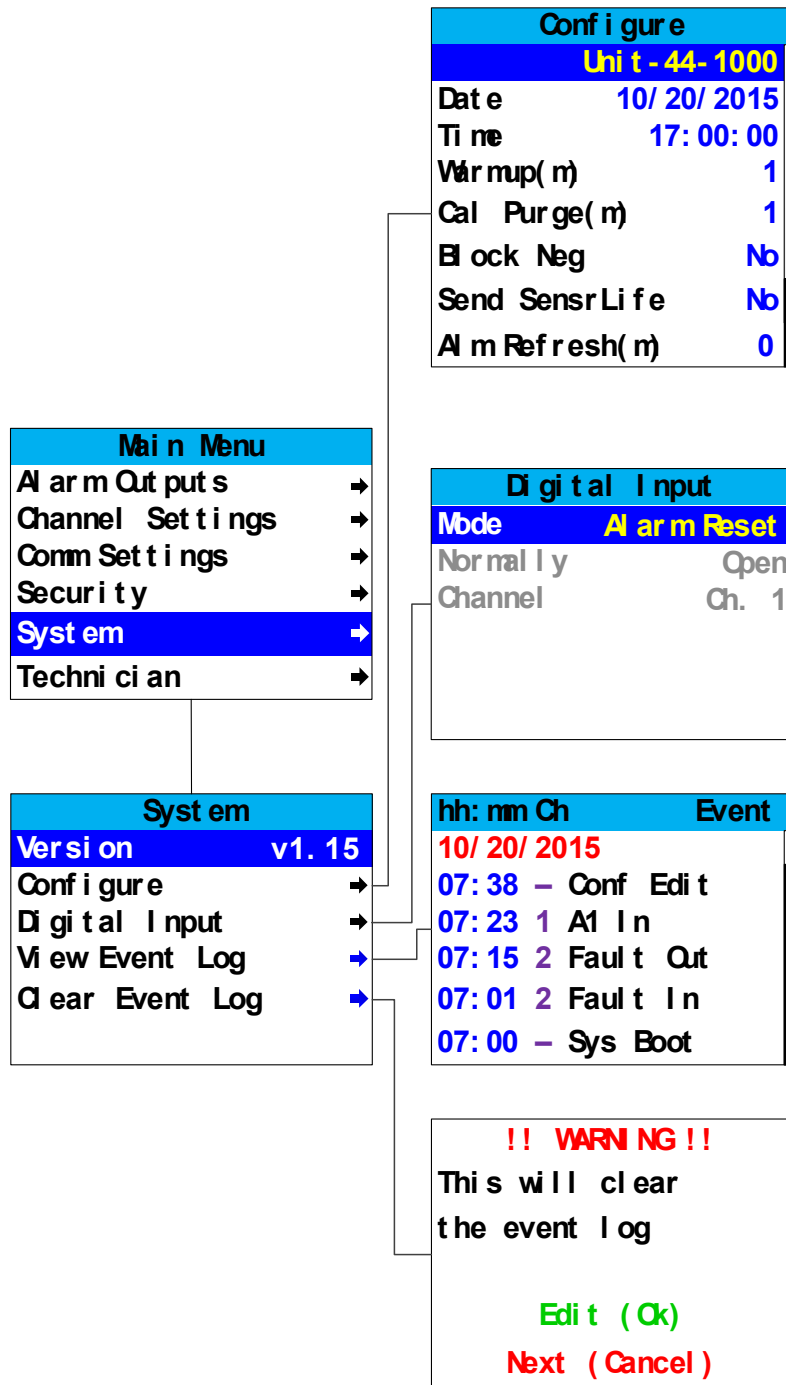

Figure 4-33 System Menu Tree

The **System Menu** is accessed through the Main Menu. System Menu items are items which effect the entire SenSmart 6000, and are not specific to either channel. Submenus are accessed by highlighting the desired item and swiping the Edit key.

4.7.1 VERSION

| System | |
|-----------------|-------|
| Version | v1.15 |
| Configure | → |
| Digital Input | → |
| View Event Log | → |
| Clear Event Log | → |

Figure 4-34 System Menu

The **Version** line in the System Menu displays the version of firmware that is programmed in the SenSmart 6000.

4.7.2 CONFIGURE

| Configure | |
|-----------------|------------|
| Unit - 44-1000 | |
| Date | 10/20/2013 |
| Time | 17:00:00 |
| Warmup(m) | 1 |
| Cal Purge(m) | 1 |
| Block Neg | No |
| Send Sensr Life | No |
| Alm Refresh(m) | 0 |

Figure 4-35 Configure System Menu

Configure Menu items are edited by highlighting the desired item and swiping Edit. Swipe UP and DOWN keys to change the value highlighted by the cursor and NEXT to move the cursor. Swipe EDIT again to save the value.

4.7.2.1 UNIT NAME

Unit Name is used to assign the transmitter a name for use in the backup configuration file name. The unit name is limited to 16 characters.

4.7.2.2 DATE

Date is used for Data and Event Logging. This is a factory setting, but may need to be adjusted for the end user's location.

4.7.2.3 TIME

Time (24 hour clock) is used for Data and Event Logging. This is a factory setting, but may need to be adjusted for the end user's location.

4.7.2.4 WARMUP (M)

Warmup is available to prevent unwanted alarm trips during sensor warmup. This time can be adjusted up to five minutes for sensors that take a long time to warm up.

4.7.2.5 CAL PURGE (M)

Cal Purge is available to prevent unwanted alarm trips during calibration purge time. This time can be adjusted up to five minutes for sensors that take a long time to drift back down after calibration.

4.7.2.6 BLOCK NEG

Block Neg prevents negative channel values from being displayed. It applies to both channels.

4.7.2.7 SEND SENSLIFE



Important: In order for the Sensor Life to be read by the receiver, the **Cal Marker** setting must correspond to the **In Cal** setting of the transmitter. Otherwise, the receiver will not check for the sensor life data from the transmitter after calibration is completed.



Note: For Oxygen sensors, the Cal Marker setting is set at 83% of full scale on a 0-25% zero to span range. This allows sensor life information to be transmitted with the upscale values associated with Oxygen sensors.

4.7.2.7.1 4-20MA OUTPUT

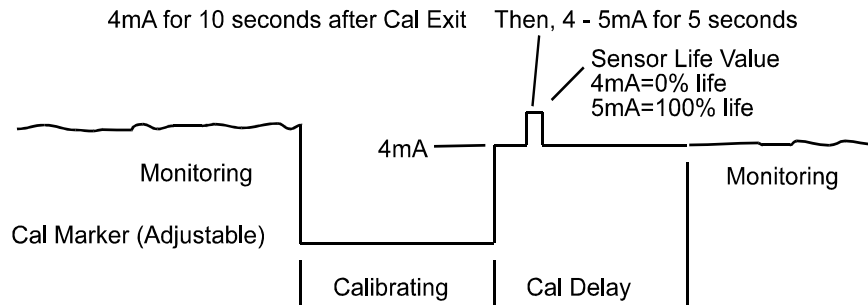

Figure 4-36 Send SensrLife Timing Diagram

Set for Yes, **Send SensrLife** causes the SenSmart 6000 to transmit a sensor life value after successful calibrations during the Cal Purge Delay. Normal operation is the SenSmart 6000 transmits 4mA during the Cal Purge Delay, but with Send SensrLife set to Yes it will transmit 4mA for the first 10 seconds then for 5 seconds it will transmits a value between 4mA and 5mA, with 4mA equal to 0% sensor life and 5mA equal to 100% sensor life. The output then returns to 4mA for the remainder of the Cal Purge Delay. For example, if after a calibration sensor life is 75%, the SenSmart 6000 transmits 4.75mA during the 5 second interval.



Note: Send SensrLife should always be set for No unless the 4-20 mA receiver is capable of interpreting the sensor life signal. The R.C. Systems ST-72 and ST-71 are both capable of this function.

4.7.2.7.2 MODBUS OUTPUT

Unlike the 4-20mA output for Sensor Life, timing is not precise. When the master detects the transmitter has exited the **Cal Marker** state it will read the sensor life Modbus register to obtain the sensor life information.

4.7.2.8 ALM REFRESH (M)

Alarm Refresh allows reactivation of Acknowledged alarms after the time period expires. This feature is used primarily to restart audible alarm devices after having been silenced by an acknowledge function (via serial port or swiping the Up/Reset button). An entry of 0 minutes effectively disables the Alarm Refresh function. A maximum of 60 minutes is allowed.

4.7.3 DIGITAL INPUT

| Digital Input | |
|---------------|-------------|
| Mode | Alarm Reset |
| Normally | Open |
| Channel | Ch. 1 |

Figure 4-37 Digital Input System Menu

If a digital input is installed on the 10-0388 Relay/RS-485 Option Board, the Digital Input Menu can be set to one of three available configuration options:

1. *Alarm Reset* – when selected any active alarms, acknowledge enabled, will be acknowledged and reset when an input is received.
2. *A3 Override* – when selected, Alarm 3 will be activated on the selected channels when a signal is received. The *Normally* menu option refers to the type of connection to the digital input. If the input is normally a short it should be set to Normally Closed, otherwise it should be set to open (This is useful in a similar manner to the Failsafe mode mentioned in [Section 4.3.1.3.](#))
3. *Flt Override* – when selected, the Fault Alarm will be activated on the selected channels when a signal is received. The *Normally* menu option refers to the type of connection to the digital input. If the input is normally a short it should be set to Normally Closed, otherwise it should be set to open (This is useful in a similar manner to the Failsafe mode mentioned in [Section 4.3.1.3.](#))

4.7.4 VIEW EVENT LOG

| hh: mm Ch | Event |
|---------------------|-------------------|
| 10/ 20/ 2013 | |
| 07: 38 - | Conf Edi t |
| 07: 23 1 | Al I n |
| 07: 15 2 | Faul t Out |
| 07: 01 2 | Faul t I n |
| 07: 00 - | Sys Boot |

Figure 4-38 View Event Log System Menu

View Event Log displays the Event Log for the unit, which displays the last 100 events. Swipe up and down to scroll through the log. Entries have a date and time stamp followed by the channel number (or dash for system entries) and the type of event logged.

Logged events include:

1. Alarms/Fault In and Out
2. Alarm and Remote Alarm Resets
3. Alarm Refresh
4. Event Log Cleared
5. Configuration Changed
6. Calibration in and out
7. System and Cold Boots
8. Communication and Configuration Errors
9. Corrupt Sensor
10. Sensor Error
11. Configuration Edits

4.7.5 CLEAR EVENT LOG

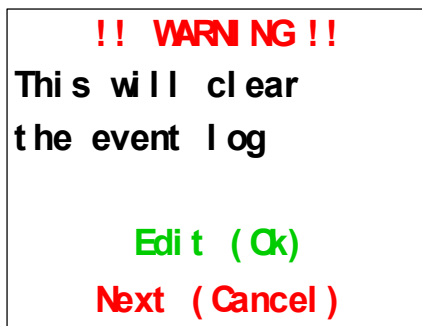

Figure 4-39 Clear Event Log System Menu

Clear Event Log clears the event log, swipe the Edit key to confirm.

4.8 TECHNICIAN

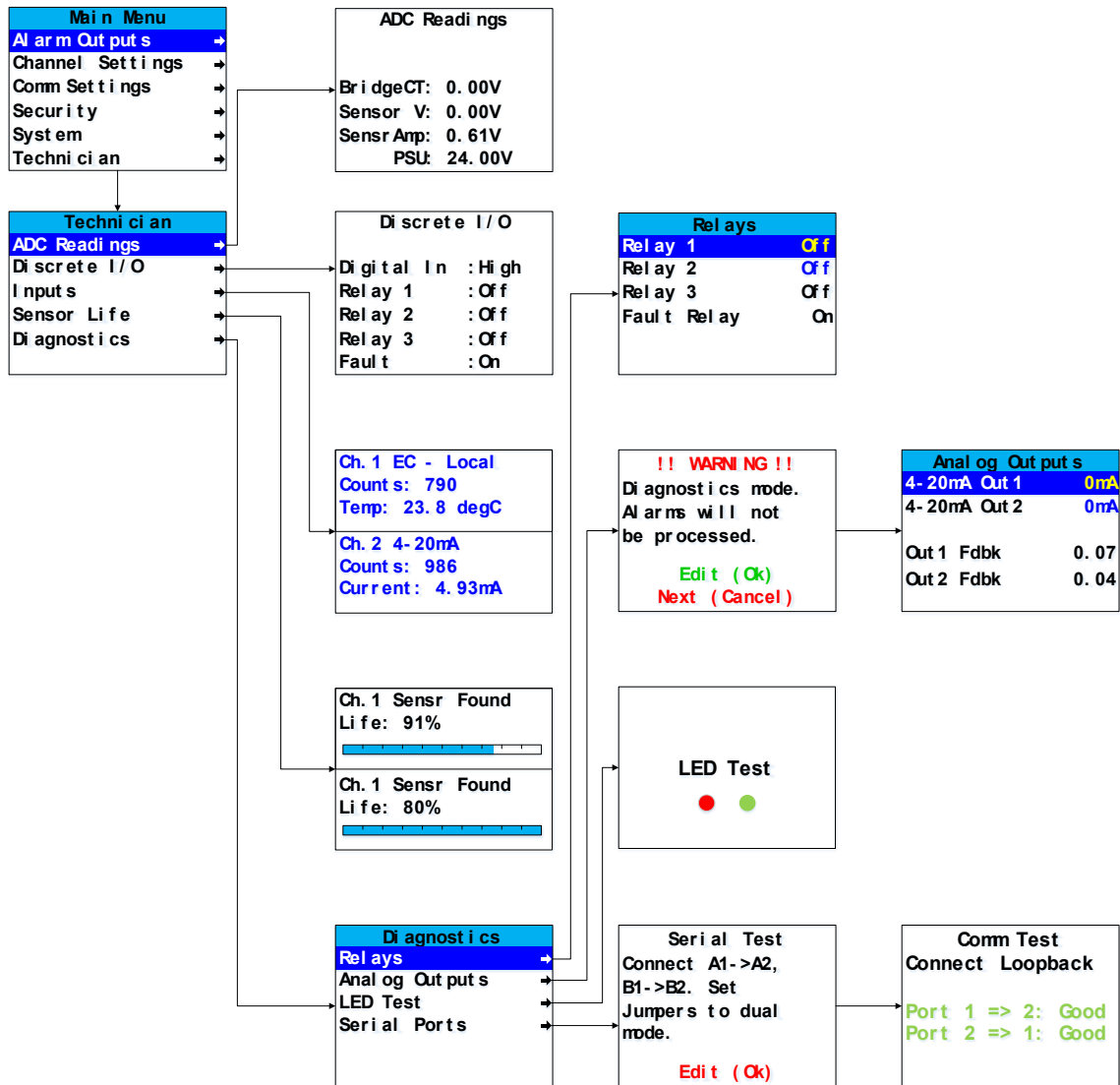

Figure 4-40 Diagnostics Menu Tree

The Technician Menu, shown in Figure 4-40, provides access to a variety of useful troubleshooting screens to view ADC Readings, Discrete I/O, Current Inputs, Sensor Life and access to the Diagnostics Mode.

4.8.1 ADC READINGS

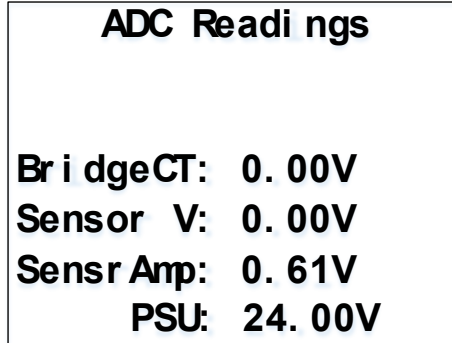

Figure 4-41 ADC Readings Menu

The **ADC Readings** displays Channel 1/2 4-20mA output and feedback current, sensor voltage for bridge inputs and sensor amplifier and power supply voltage as shown in Figure 4-42. These values may be useful to technicians when trying to determine whether or not a sensor is working properly.

The Fdbk1 and Fdbk2 can be useful in determining if there are issues with the output. A circuit is installed on each of the two outputs which measures the actual current flow out of the output terminals. If this number reads zero when an output is stimulated, it could indicate that there is a cut wire or some other failure in connection with the wiring to the controller.

4.8.2 DISCRETE I/O

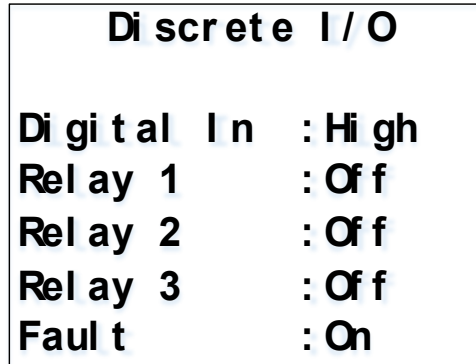

Figure 4-42 Discrete I/O Menu

4.8.3 INPUTS

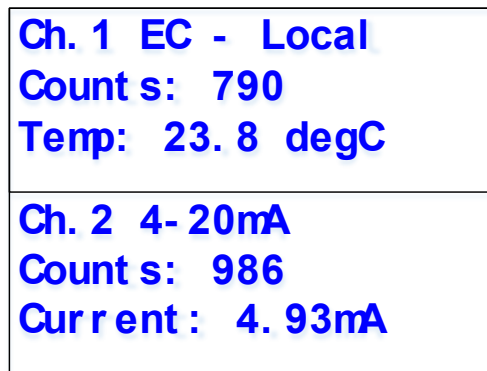

Figure 4-43 Inputs Menu

The **Inputs Menu** displays both channel's raw counts and input data.

4.8.4 SENSOR LIFE

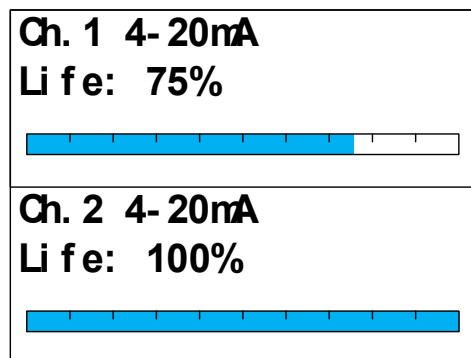

Figure 4-44 View Sensor Life System Menu

View Sensor Life provides an indication of the Sensor Life remaining. This percentage is calculated by comparing the amount of gain needed to be applied at the most recent calibration when compared to the amount of gain needed to be applied at the initial calibration.

4.8.5 DIAGNOSTICS

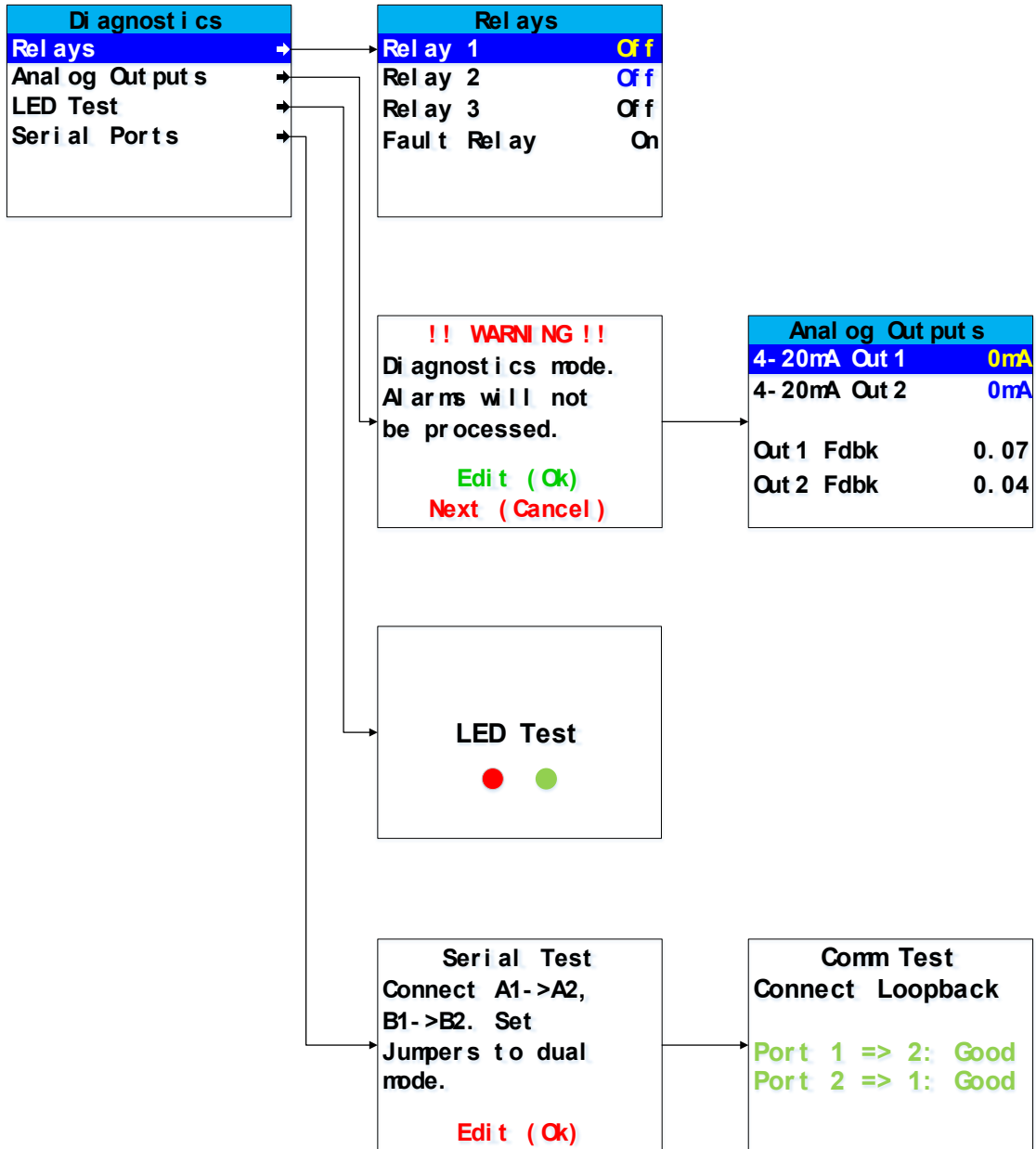

Figure 4-45 Diagnostics Mode Menu Tree

A System Diagnostic Mode shown in Figure 4-40 may be entered during normal operation from the Technician Menu. The entry menu offers useful routines for testing front panel LEDs, relays, serial ports, ADC readings and analog I/O. It is exited manually by swiping the Next key with a magnet, and automatically if no keys are swiped for five minutes.



Caution: It is very important to understand that **CHANNEL DATA IS NOT PROCESSED DURING THE SYSTEM DIAGNOSTICS MODE**. It is possible to miss important input values while utilizing this mode, and appropriate safeguards should be in place. However, the System Diagnostics Mode can prove invaluable when testing I/O since relays and analog outputs may be stimulated without driving inputs to precise levels.

4.8.5.1 RELAYS

| Rel ays | |
|---------------|------|
| Rel ay 1 | Of f |
| Rel ay 2 | Of f |
| Rel ay 3 | Of f |
| Faul t Rel ay | On |

Figure 4-46 Relay Diagnostic Menu

The **Relays Menu** allows manual actuation of the Relays (optional 10-0388 SenSmart 6000 Relay/RS-485 Option Board) while in the System Diagnostics Mode. Highlight the relay to be actuated and swipe Edit. Confirm relay actuation, and swipe Edit again to de-energize the relay.

4.8.5.2 ANALOG OUTPUTS

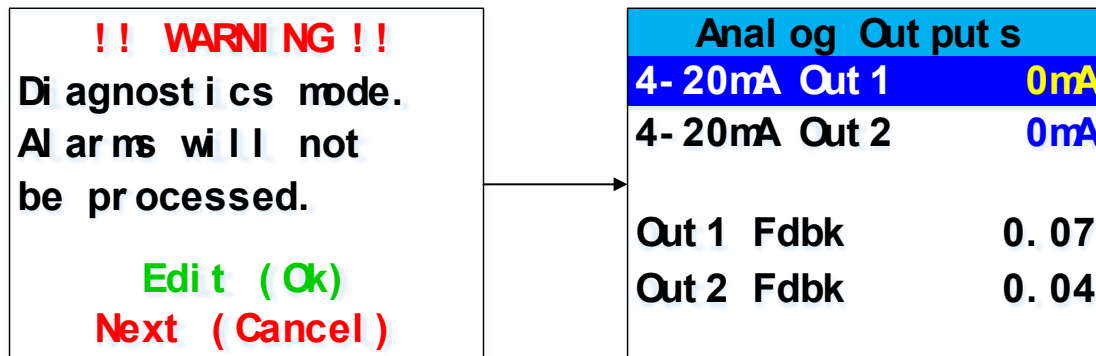

Figure 4-47 Analog Outputs Diagnostics Menu

Analog Outputs manually stimulates the 4-20mA outputs by selecting the channel and swiping EDIT. Each swipe increments the output by 4mA from 0-20mA. The Out1 Fdbk and Out2 Fdbk can be useful in determining if there are issues with the output. A circuit is installed on each of the two outputs which measures the actual current flow out of the output terminals. If this number reads zero when an output is stimulated, it could indicate that there is a cut wire or some other failure in connection with the wiring to the controller.

4.8.5.3 LED TEST

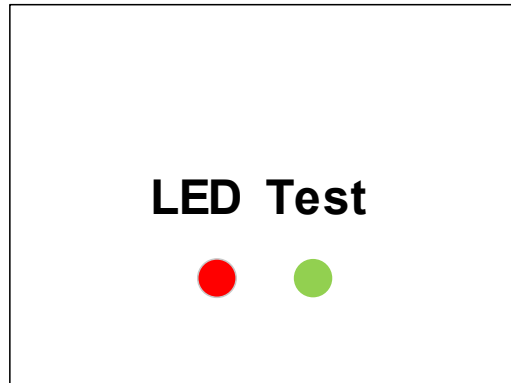

Figure 4-48 LED Test Diagnostics Menu

LED Test causes the two LEDs on the front panel to blink alternating red and green.

4.8.5.4 SERIAL PORTS

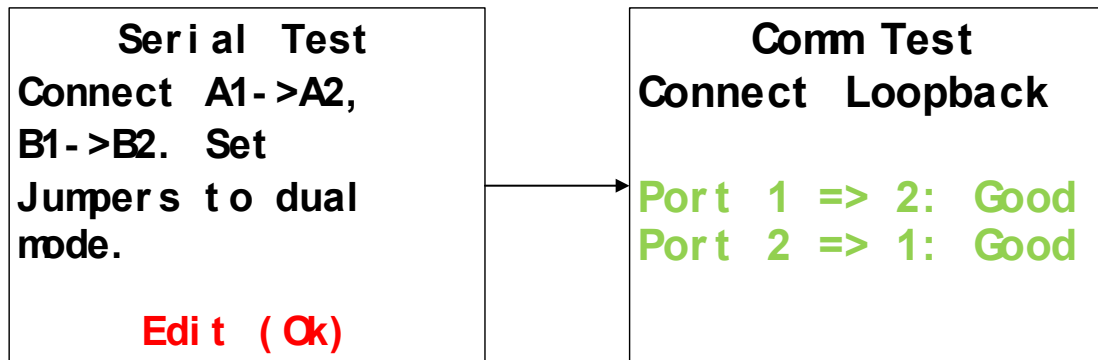

Figure 4-49 Serial Ports Diagnostics Menu

Serial Ports is used to test the two communication ports on the optional 10-0388 Relay/RS-485 Modbus Option Board. To test the Serial Ports connect A1 to A2 and B1 to B2, and set jumpers J3 and J5 to dual port mode, position B. The screen will then display a Good or Bad status report as shown in Figure 4-41.

Chapter 5 Modbus

The SenSmart 6000 may be equipped with two optional (10-0388 Relay/RS-485 Modbus Option Board) RS-485 ports which can be independently configured as Modbus master or slave. Chapter 5 defines register locations of data available via the SenSmart 6000 slave port.

5.1 MODBUS TCP

In addition to the RS-485 ports, the SenSmart 6000 supports both master and slave Modbus TCP. Modbus TCP is always enabled through the Ethernet port. The unit can be polled by its IP Address. When Modbus TCP slave is used, the Slave ID field of the message is ignored. Channels can be configured to poll using the SenSmart 6000's Modbus TCP master interface. Devices are polled by IP Address.

5.2 MODBUS SLAVE WRITES

The Modbus slave ports allow function code 5(write coil), as well as function code 6, and 16 (write holding registers). These function codes can be used to write configuration parameters to the SenSmart 6000. By default, all Modbus writes are disabled except the unlock parameter 40099. The Modbus lock code can be written to register 40099 to enable writes to other registers. The unit will be unlocked for 10 minutes after the last write occurs. After the 10 minute timeout, the unit will automatically save any parameters that have been written to. All written parameters can be saved manually by writing a value of 1 to coil 95 or register 40095.

Writing parameters that span multiple register (such as 32bit floating points) requires function code 16. All registers must be written at once.

5.3 MODBUS SLAVE REGISTER LOCATION

The following table describes the SenSmart 6000's Modbus slave database. Any portion of this data may be read by a Modbus master device such as a PC, PLC or DCS. Since the Modbus port is RS-485, multiple SenSmart 6000s may be multi-dropped onto the same cable.

| Input Registers | | | | | |
|------------------------|-------|------|-------|------|--|
| Variable Name | Alias | Read | Write | Size | Notes |
| Ch 1 Analog Output Raw | 31001 | 4 | N/A | 1 | 12 bit value; 800 = 4mA; 4000 = 20mA |
| Ch 2 Analog Output Raw | 31002 | 4 | N/A | 1 | 12 bit value; 800 = 4mA; 4000 = 20mA |
| Ch 1 A2D Raw Counts | 31003 | 4 | N/A | 1 | 12 bit value from A/D converter |
| Ch 2 A2D Raw Counts | 31004 | 4 | N/A | 1 | 12 bit value from A/D converter |
| Ch 1 Sensor Life | 31009 | 4 | N/A | 1 | 16 bit signed integer ranging from -1 to 100 where -1 indicates Cal Required |
| Ch 2 Sensor Life | 31010 | 4 | N/A | 1 | 16 bit signed integer ranging from -1 to 100 where -1 indicates Cal Required |
| Ch 1 Sensor Temp | 31011 | 4 | N/A | 1 | 16 bit integer from 1 to 4095 scaled for -55°C to +125°C |

| | | | | | |
|--|-------|---|-----|---|---|
| Ch 2 Sensor Temp | 31012 | 4 | N/A | 1 | 16 bit integer from 1 to 4095 scaled for -55°C to +125°C |
| Ch 1 4-20mA Out FP | 31210 | 4 | N/A | 2 | 32 bit floating point |
| Ch 2 4-20mA Out FP | 31212 | 4 | N/A | 2 | 32 bit floating point |
| Ch 1 Output Feedback FP | 31214 | 4 | N/A | 2 | 32 bit floating point |
| Ch 2 Output Feedback FP | 31216 | 4 | N/A | 2 | 32 bit floating point |
| 12V Input FP | 31218 | 4 | N/A | 2 | 32 bit floating point |
| Sensor Volts FP | 31220 | 4 | N/A | 2 | 32 bit floating point |
| Bridge Amp FP | 31222 | 4 | N/A | 2 | 32 bit floating point |
| Bridge Out FP | 31224 | 4 | N/A | 2 | 32 bit floating point |
| Product ID | 32001 | 4 | N/A | 1 | Factory use only |
| Version | 32002 | 4 | N/A | 1 | Factory use only |
| Custom Feature | 32003 | 4 | N/A | 1 | Factory use only |
| Customer ID | 32004 | 4 | N/A | 1 | Factory use only |
| Lock Status | 32005 | 4 | N/A | 1 | Factory use only |
| Boot Year | 32006 | 4 | N/A | 1 | Last power-up time & date |
| Boot Month | 32007 | 4 | N/A | 1 | Last power-up time & date |
| Boot Day | 32008 | 4 | N/A | 1 | Last power-up time & date |
| Boot Hour | 32009 | 4 | N/A | 1 | Last power-up time & date |
| Boot Minute | 32010 | 4 | N/A | 1 | Last power-up time & date |
| Boot Second | 32011 | 4 | N/A | 1 | Last power-up time & date |
| SR 1 State | 32020 | 4 | N/A | 1 | True if relay #1 active |
| SR 2 State | 32021 | 4 | N/A | 1 | True if relay #2 active |
| SR 3 State | 32022 | 4 | N/A | 1 | True if relay #3 active |
| FR State | 32023 | 4 | N/A | 1 | True if fault relay active |
| Warmup | 32025 | 4 | N/A | 1 | True if unit in warm-up |
| SR 1 Flashing | 32026 | 4 | N/A | 1 | True if relay #1 flashing |
| SR 2 Flashing | 32027 | 4 | N/A | 1 | True if relay #2 flashing |
| SR 3 Flashing | 32028 | 4 | N/A | 1 | True if relay #3 flashing |
| FR Flashing | 32029 | 4 | N/A | 1 | True if fault relay flashing |
| DI State | 32030 | 4 | N/A | 1 | Digital input status |
| Ch 1 Fixed Point | 33001 | 4 | N/A | 1 | 16bit representation of float w/ +-5% over/under range. * see formula |
| CH 2 Fixed Point | 33002 | 4 | N/A | 1 | 16bit representation of float w/ +-5% over/under range. * see formula |
| <p>*</p> $\text{DisplayValue} := \frac{\text{ModbusRegisterValue} \cdot (\text{SpanValue} - \text{ZeroValue}) \cdot 1.1}{32767} + \text{ZeroValue} - (\text{SpanValue} - \text{ZeroValue}) \cdot 0.05$ | | | | | |

| | | | | | |
|--------------------------|-------|---|-----|---|---|
| Ch 1 Floating Point | 33010 | 4 | N/A | 2 | 32 bit IEEE 754 float |
| Ch 1 Value String | 33012 | 4 | N/A | 3 | 6 character string ;zero terminated |
| Ch 1 Temperature Float | 33015 | 4 | N/A | 2 | Sensor temperature |
| Ch 1 A1 Status | 33017 | 4 | N/A | 1 | True if alarm 1 active |
| Ch 1 A1 Flashing | 33018 | 4 | N/A | 1 | True if alarm 1 indicator flashing |
| Ch 1 A2 Status | 33019 | 4 | N/A | 1 | True if alarm 2 active |
| Ch 1 A2 Flashing | 33020 | 4 | N/A | 1 | True if alarm 2 indicator flashing |
| Ch 1 A3 Status | 33021 | 4 | N/A | 1 | True if alarm 3 active |
| Ch 1 A3 Flashing | 33022 | 4 | N/A | 1 | True if alarm 3 indicator flashing |
| Ch 1 Fault Status | 33023 | 4 | N/A | 1 | True if fault active |
| Ch 1 Comm Error | 33024 | 4 | N/A | 1 | True if comm error |
| Ch 1 Config Error | 33025 | 4 | N/A | 1 | True if config error |
| Ch 1 I/O Error | 33026 | 4 | N/A | 1 | True if input/output error |
| Ch 1 Cal Flag | 33027 | 4 | N/A | 1 | True if calibration in progress |
| Ch 1 Marker Flag | 33028 | 4 | N/A | 1 | True if marker active |
| Ch 1 Linearize | 33029 | 4 | N/A | 1 | True if linearization table active |
| Ch 1 Err Flashing | 33030 | 4 | N/A | 1 | True if channel error |
| Ch 1 Uncompensated Value | 33032 | 4 | N/A | 2 | Floating point EUnit value without temperature compensation applied |
| Ch 1 Smart Sensor Error | 33034 | 4 | N/A | 6 | No Error = 0, Over range = 1, Cal Required = 3, Gas Type Mismatch = 5, Missing Sensor = 8, Corrupt Sensor = 9 |
| Ch 2 Floating Point | 33040 | 4 | N/A | 2 | 32 bit IEEE 754 float |
| Ch 2 Value String | 33042 | 4 | N/A | 3 | 6 character string ;zero terminated |
| Ch 2 Temp Float | 33045 | 4 | N/A | 2 | Sensor temperature |
| Ch 2 A1 Status | 33047 | 4 | N/A | 1 | True if alarm 1 active |
| Ch 2 A1 Flashing | 33048 | 4 | N/A | 1 | True if alarm 1 indicator flashing |
| Ch 2 A2 Status | 33049 | 4 | N/A | 1 | True if alarm 2 active |
| Ch 2 A2 Flashing | 33050 | 4 | N/A | 1 | True if alarm 2 indicator flashing |
| Ch 2 A3 Status | 33051 | 4 | N/A | 1 | True if alarm 3 active |
| Ch 2 A3 Flashing | 33052 | 4 | N/A | 1 | True if alarm 3 indicator flashing |
| Ch 2 Fault Status | 33053 | 4 | N/A | 1 | True if fault active |
| Ch 2 Comm Error | 33054 | 4 | N/A | 1 | True if comm error |
| Ch 2 Config Error | 33055 | 4 | N/A | 1 | True if config error |
| Ch 2 I/O Error | 33056 | 4 | N/A | 1 | True if input/output error |
| Ch 2 Cal Flag | 33057 | 4 | N/A | 1 | True if calibration in progress |
| Ch 2 Marker Flag | 33058 | 4 | N/A | 1 | True if marker active |
| Ch 2 Linearize | 33059 | 4 | N/A | 1 | True if linearization table active |
| Ch 2 Err Flashing | 33060 | 4 | N/A | 1 | True if channel error |

| | | | | | |
|--------------------------|-------|-----|------|----|---|
| Ch 2 Uncompensated Value | 33062 | 4 | N/A | 2 | Floating point EUnit value without temperature compensation applied |
| Ch 2 Smart Sensor Error | 33064 | 4 | N/A | 6 | No Error = 0, Over range = 1, Cal Required = 3, Gas Type Mismatch = 5, Missing Sensor = 8, Corrupt Sensor = 9 |
| Alarm Reset | 40001 | N/A | 3 | 9 | Write to acknowledge alarm |
| System Name | 40010 | 4 | N/A | 8 | 16 character ASCII text |
| Holding Registers | | | | | |
| Date Year | 40020 | 3 | 6,16 | 1 | Current time & date |
| Date Month | 40021 | 3 | 6,16 | 1 | Current time & date |
| Date Day | 40022 | 3 | 6,16 | 1 | Current time & date |
| Date Hour | 40023 | 3 | 6,16 | 1 | Current time & date |
| Date Minute | 40024 | 3 | 6,16 | 1 | Current time & date |
| Date Second | 40025 | 3 | 6,16 | 1 | Current time & date |
| Refresh Time | 40026 | 3 | 6,16 | 1 | Alarm refresh (minutes) |
| Warmup Time | 40027 | 3 | 6,16 | 1 | Warm up delay (minutes) |
| Cal Purge Time | 40028 | 3 | 6,16 | 1 | Cal purge delay (minutes) |
| Block Negative Flag | 40029 | 3 | 6,16 | 1 | True if prohibit display of neg values |
| Comm 1 Function | 40030 | 3 | 6,16 | 1 | MODBUS serial port #1 |
| Comm 1 Baud Rate | 40031 | 3 | 6,16 | 1 | MODBUS serial port #1 |
| Comm 1 Parity | 40032 | 3 | 6,16 | 1 | MODBUS serial port #1 |
| Comm 1 Slave ID | 40033 | 3 | 6,16 | 1 | MODBUS serial port #1 |
| Comm 1 Timeout | 40034 | 3 | 6,16 | 1 | MODBUS serial port #1 |
| Comm 1 Poll Delay | 40035 | 3 | 6,16 | 1 | MODBUS serial port #1 |
| Comm 1 Byte Order | 40036 | 3 | 6,16 | 2 | MODBUS serial port #1 |
| Comm 1 LED Enable | 40038 | 3 | 6,16 | 2 | MODBUS serial port #1 |
| Comm 2 Function | 40040 | 3 | 6,16 | 2 | MODBUS serial port #2 |
| Comm 2 Baud Rate | 40041 | 3 | 6,16 | 1 | MODBUS serial port #2 |
| Comm 2 Parity | 40042 | 3 | 6,16 | 1 | MODBUS serial port #2 |
| Comm 2 Slave ID | 40043 | 3 | 6,16 | 1 | MODBUS serial port #2 |
| Comm 2 Timeout | 40044 | 3 | 6,16 | 1 | MODBUS serial port #2 |
| Comm 2 Poll Delay | 40045 | 3 | 6,16 | 1 | MODBUS serial port #2 |
| Comm 2 Byte Order | 40046 | 3 | 6,16 | 1 | MODBUS serial port #2 |
| Comm 2 LED Enable | 40048 | 3 | 6,16 | 2 | MODBUS serial port #2 |
| DHCP Enabled | 40050 | 3 | 6,16 | 2 | Ethernet port; DHCP or fixed address |
| Host Name | 40051 | 3 | 6,16 | 15 | Ethernet port: 16 ASCII characters |
| IP Address | 40066 | 3 | 6,16 | 4 | Ethernet port: xxx.xxx.xxx.xxx |
| Net Mask | 40070 | 3 | 6,16 | 4 | Ethernet port: xxx.xxx.xxx.xxx |
| Gateway IP | 40074 | 3 | 6,16 | 6 | Ethernet port: xxx.xxx.xxx.xxx |

| | | | | | |
|-----------------------|-------|---|------|----|--|
| Modbus TCP Byte Order | 40080 | 3 | 6,16 | 1 | MODBUS/TCP function |
| Modbus TCP Timeout | 40081 | 3 | 6,16 | 1 | MODBUS/TCP timeout (mSec) |
| Modbus TCP Poll Delay | 40082 | 3 | 6,16 | 1 | MODBUS/TCP poll delay (mSec) |
| LED Enable | 40083 | 3 | 6,16 | 12 | 0 = Disable, 1 = Enable |
| Save Config | 40095 | 3 | 6,16 | 12 | Write command to save local config |
| Config Changed | 40096 | 3 | 6,16 | 3 | True if config changed since last read |
| Security Unlock | 40099 | 3 | 6,16 | 2 | Unused |
| Relay 1 A1 Votes | 40101 | 3 | 6,16 | 1 | Alarm relay #1 configuration |
| Relay 1 A2 Votes | 40102 | 3 | 6,16 | 1 | Alarm relay #1 configuration |
| Relay 1 A3 Votes | 40103 | 3 | 6,16 | 1 | Alarm relay #1 configuration |
| Relay 1 Fault Votes | 40104 | 3 | 6,16 | 1 | Alarm relay #1 configuration |
| Relay 1 Override | 40105 | 3 | 6,16 | 2 | Alarm relay #1 configuration |
| Relay 1 Ack | 40107 | 3 | 6,16 | 1 | Alarm relay #1 configuration |
| Relay 1 Failsafe | 40108 | 3 | 6,16 | 3 | Alarm relay #1 configuration |
| Relay 2 A1 Votes | 40111 | 3 | 6,16 | 1 | Alarm relay #2 configuration |
| Relay 2 A2 Votes | 40112 | 3 | 6,16 | 1 | Alarm relay #2 configuration |
| Relay 2 A3 Votes | 40113 | 3 | 6,16 | 1 | Alarm relay #2 configuration |
| Relay 2 Fault Votes | 40114 | 3 | 6,16 | 1 | Alarm relay #2 configuration |
| Relay 2 Override | 40115 | 3 | 6,16 | 2 | Alarm relay #2 configuration |
| Relay 2 Ack | 40117 | 3 | 6,16 | 1 | Alarm relay #2 configuration |
| Relay 2 Failsafe | 40118 | 3 | 6,16 | 3 | Alarm relay #2 configuration |
| Relay 3 A1 Votes | 40121 | 3 | 6,16 | 1 | Alarm relay #3 configuration |
| Relay 3 A2 Votes | 40122 | 3 | 6,16 | 1 | Alarm relay #3 configuration |
| Relay 3 A3 Votes | 40123 | 3 | 6,16 | 1 | Alarm relay #3 configuration |
| Relay 3 Fault Votes | 40124 | 3 | 6,16 | 1 | Alarm relay #3 configuration |
| Relay 3 Override | 40125 | 3 | 6,16 | 2 | Alarm relay #3 configuration |
| Relay 3 Ack | 40127 | 3 | 6,16 | 1 | Alarm relay #3 configuration |
| Relay 3 Failsafe | 40128 | 3 | 6,16 | 3 | Alarm relay #3 configuration |
| Digital Input Mode | 40150 | 3 | 6,16 | 1 | Alarm ack or flow switch input |
| Digital Input Type | 40151 | 3 | 6,16 | 1 | Alarm ack or flow switch input |
| Digital Input Mode | 40152 | 3 | 6,16 | 1 | Alarm ACK or flow switch input |
| Send Sensor Life | 40153 | 3 | 6,16 | 1 | True if transmit sensor life value |
| Contact Info String | 40160 | 3 | 6,16 | 8 | 16 ASCII characters (2 per register) |
| Ch 1 Measurement Name | 40401 | 3 | 16 | 8 | 16 ASCII characters (2 per register) |
| Ch 2 Measurement Name | 40409 | 3 | 16 | 8 | 16 ASCII characters (2 per register) |
| Ch 1 EUNITS | 40423 | 3 | 16 | 5 | 10 ASCII characters (2 per register) |
| Ch 2 EUNITS | 40428 | 3 | 16 | 5 | 10 ASCII characters (2 per register) |
| Ch 1 Preamp gain | 40433 | 3 | 6,16 | 1 | Contact factory |

| | | | | | |
|-------------------------|-------|---|------|---|------------------------------------|
| Ch 2 Preamp gain | 40434 | 3 | 6,16 | 1 | Contact factory |
| Ch 1 Cal Zero | 42001 | 3 | 6,16 | 2 | Modbus 32 bit IEEE 754 Floating Pt |
| Ch 1 Cal Span | 42003 | 3 | 6,16 | 2 | Modbus 32 bit IEEE 754 Floating Pt |
| Ch 1 Zero Value | 42005 | 3 | 6,16 | 2 | Modbus 32 bit IEEE 754 Floating Pt |
| Ch 1 Span Value | 42007 | 3 | 6,16 | 2 | Modbus 32 bit IEEE 754 Floating Pt |
| Ch 1 Fault Value | 42009 | 3 | 6,16 | 2 | Modbus 32 bit IEEE 754 Floating Pt |
| Ch 1 Alarm 1 Setpoint | 42011 | 3 | 6,16 | 2 | Modbus 32 bit IEEE 754 Floating Pt |
| Ch 1 Alarm 2 Setpoint | 42013 | 3 | 6,16 | 2 | Modbus 32 bit IEEE 754 Floating Pt |
| Ch 1 Alarm 3 Setpoint | 42015 | 3 | 6,16 | 2 | Modbus 32 bit IEEE 754 Floating Pt |
| Ch 1 Manual Gain | 42017 | 3 | 6,16 | 2 | Modbus 32 bit IEEE 754 Floating Pt |
| Ch 1 Manual Offset | 42019 | 3 | 6,16 | 2 | Modbus 32 bit IEEE 754 Floating Pt |
| Ch 2 Cal Zero Value | 42021 | 3 | 6,16 | 2 | Modbus 32 bit IEEE 754 Floating Pt |
| Ch 2 Cal Span Value | 42023 | 3 | 6,16 | 2 | Modbus 32 bit IEEE 754 Floating Pt |
| Ch 2 Zero Value | 42025 | 3 | 6,16 | 2 | Modbus 32 bit IEEE 754 Floating Pt |
| Ch 2 Span Value | 42027 | 3 | 6,16 | 2 | Modbus 32 bit IEEE 754 Floating Pt |
| Ch 2 Fault Value | 42029 | 3 | 6,16 | 2 | Modbus 32 bit IEEE 754 Floating Pt |
| Ch 2 Alarm 1 Setpoint | 42031 | 3 | 6,16 | 2 | Modbus 32 bit IEEE 754 Floating Pt |
| Ch 2 Alarm 2 Setpoint | 42033 | 3 | 6,16 | 2 | Modbus 32 bit IEEE 754 Floating Pt |
| Ch 2 Alarm 3 Setpoint | 42035 | 3 | 6,16 | 2 | Modbus 32 bit IEEE 754 Floating Pt |
| Ch 2 Manual Gain | 42037 | 3 | 6,16 | 2 | Modbus 32 bit IEEE 754 Floating Pt |
| Ch 2 Manual Offset | 42039 | 3 | 6,16 | 2 | Modbus 32 bit IEEE 754 Floating Pt |
| Ch 1 Alarm 1 Latch | 43001 | 3 | 6,16 | 1 | False = NO; True = YES |
| Ch 1 Alarm 1 Trip | 43002 | 3 | 6,16 | 1 | False = HIGH ;True = LOW |
| Ch 1 Alarm 1 On Delay | 43003 | 3 | 6,16 | 1 | Activation delay in seconds |
| Ch 1 Alarm 1 Off Delay | 43004 | 3 | 6,16 | 1 | Deactivation delay in minutes |
| Ch 1 Alarm 1 Hysteresis | 43005 | 3 | 6,16 | 6 | Percent of scale |
| Ch 1 Alarm 2 Latch | 43011 | 3 | 6,16 | 1 | False = NO; True = YES |
| Ch 1 Alarm 2 Trip | 43012 | 3 | 6,16 | 1 | False = HIGH ;True = LOW |
| Ch 1 Alarm 2 On Delay | 43013 | 3 | 6,16 | 1 | Activation delay in seconds |
| Ch 1 Alarm 2 Off Delay | 43014 | 3 | 6,16 | 1 | Deactivation delay in minutes |
| Ch 1 Alarm 2 Hysteresis | 43015 | 3 | 6,16 | 1 | Percent of scale |
| Ch 1 Alarm 2 Color | 43016 | 3 | 6,16 | 1 | 0 = Red, 1 = Blue, 2 = Orange |
| Ch 1 Alarm 3 Latch | 43021 | 3 | 6,16 | 1 | False = NO; True = YES |
| Ch 1 Alarm 3 Trip | 43022 | 3 | 6,16 | 1 | False = HIGH ;True = LOW |
| Ch 1 Alarm 3 On Delay | 43023 | 3 | 6,16 | 1 | Activation delay in seconds |
| Ch 1 Alarm 3 Off Delay | 43024 | 3 | 6,16 | 1 | Deactivation delay in minutes |
| Ch 1 Alarm 3 Hysteresis | 43025 | 3 | 6,16 | 1 | Percent of scale |
| Ch 1 Alarm 3 Color | 43026 | 3 | 6,16 | 1 | 0 = Red, 1 = Blue, 2 = Orange |

| | | | | | |
|-----------------------|-------|---|------|---|------------------------------------|
| Ch 1 Alarm 3 Enabled | 43027 | 3 | 6,16 | 1 | False = NO; True = YES |
| Ch 1 Data From | 43031 | 3 | 6,16 | 1 | Selection |
| Ch 1 Min Raw | 43032 | 3 | 6,16 | 1 | Binary (800) |
| Ch 1 Max Raw | 43033 | 3 | 6,16 | 1 | Binary (4000) |
| Ch 1 Remote ID | 43034 | 3 | 6,16 | 1 | Binary |
| Ch 1 Interface | 43035 | 3 | 6,16 | 1 | Binary |
| Ch 1 Byte Order | 43036 | 3 | 6,16 | 1 | Byte order |
| Ch 1 Alias | 43037 | 3 | 16 | 2 | Binary; 32 bit; 2x |
| Ch 1 IP Address | 43039 | 3 | 6,16 | 2 | Binary; 4x unsigned bytes |
| Ch 1 Port | 43041 | 3 | 16 | 2 | Binary; 32 bit; 2x |
| Ch 1 Remote Sensor | 43043 | 3 | 6,16 | 1 | Binary |
| Ch 1 DP | 43079 | 3 | 6,16 | 1 | Number of decimal points |
| Ch 1 Enable | 43080 | 3 | 6,16 | 1 | False = NO; True = YES |
| Ch 1 Deadband | 43081 | 3 | 16 | 2 | Modbus 32 bit IEEE 754 Floating Pt |
| Ch 1 Marker Enable | 43083 | 3 | 6,16 | 1 | False = NO; True = YES |
| Ch 1 Marker Percent | 43084 | 3 | 16 | 2 | Modbus 32 bit IEEE 754 Floating Pt |
| Ch 1 Marker Info | 43086 | 3 | 6,16 | 3 | 6 ASCII characters |
| Ch 1 Marker Life | 43089 | 3 | 6,16 | 1 | Binary |
| Ch 1 Filter Count | 43090 | 3 | 6,16 | 1 | Binary ;0 to 60 |
| Ch 1 Radio Reg | 43091 | 3 | 6,16 | 1 | Binary |
| Ch 1 Coefficient | 43092 | 3 | 6,16 | 1 | Binary |
| Ch 1 Bridge Voltage | 43093 | 3 | 16 | 2 | Modbus 32 bit IEEE 754 Floating Pt |
| Ch 1 Balance | 43095 | 3 | 6,16 | 1 | Binary |
| Ch 1 Heater Enable | 43096 | 3 | 6,16 | 1 | False = NO; True = YES |
| Ch 1 Heater Setpoint | 43097 | 3 | 16 | 2 | Modbus 32 bit IEEE 754 Floating Pt |
| Ch 1 Temp Comp -40 | 43099 | 3 | 16 | 2 | 32 bit FP Gain ;32 bit FP Offset |
| Ch 1 Temp Comp -30 | 43103 | 3 | 16 | 2 | 32 bit FP Gain ;32 bit FP Offset |
| Ch 1 Temp Comp -20 | 43107 | 3 | 16 | 2 | 32 bit FP Gain ;32 bit FP Offset |
| Ch 1 Temp Comp -10 | 43111 | 3 | 16 | 2 | 32 bit FP Gain ;32 bit FP Offset |
| Ch 1 Temp Comp 0 | 43115 | 3 | 16 | 2 | 32 bit FP Gain ;32 bit FP Offset |
| Ch 1 Temp Comp +10 | 43119 | 3 | 16 | 2 | 32 bit FP Gain ;32 bit FP Offset |
| Ch 1 Temp Comp +20 | 43123 | 3 | 16 | 2 | 32 bit FP Gain ;32 bit FP Offset |
| Ch 1 Temp Comp +30 | 43127 | 3 | 16 | 2 | 32 bit FP Gain ;32 bit FP Offset |
| Ch 1 Temp Comp +40 | 43131 | 3 | 16 | 2 | 32 bit FP Gain ;32 bit FP Offset |
| Ch 1 Temp Comp +50 | 43135 | 3 | 16 | 2 | 32 bit FP Gain ;32 bit FP Offset |
| Ch 1 Temp Comp +60 | 43139 | 3 | 16 | 2 | 32 bit FP Gain ;32 bit FP Offset |
| Ch 1 Sensor Type CRC | 43143 | 3 | 6,16 | 1 | CRC of sensor type text |
| Ch 1 Send Sensor Life | 43144 | 3 | 6,16 | 1 | False = NO; True = YES |

| | | | | | |
|-------------------------|-------|---|------|---|------------------------------------|
| Ch 1 Cal mA Setting | 43145 | 3 | 16 | 2 | Modbus 32 bit IEEE 754 Floating Pt |
| Ch 1 Local Cal | 43147 | 3 | 6,16 | 1 | False = NO; True = YES |
| Ch 1 AI Range | 43148 | 3 | 6,16 | 1 | 0 = 0 - 20mA, 1 = 4-20mA |
| Ch 1 Initial Gain | 43149 | 3 | 6,16 | 2 | 8-bit Representation of Gain |
| Ch 2 Alarm 1 Latch | 43201 | 3 | 6,16 | 1 | False = NO; True = YES |
| Ch 2 Alarm 1 Trip | 43202 | 3 | 6,16 | 1 | False = HIGH ;True = LOW |
| Ch 2 Alarm 1 On Delay | 43203 | 3 | 6,16 | 1 | Activation delay in seconds |
| Ch 2 Alarm 1 Off Delay | 43204 | 3 | 6,16 | 1 | Deactivation delay in minutes |
| Ch 2 Alarm 1 Hysteresis | 43205 | 3 | 6,16 | 6 | Percent of scale |
| Ch 2 Alarm 2 Latch | 43211 | 3 | 6,16 | 1 | False = NO; True = YES |
| Ch 2 Alarm 2 Trip | 43212 | 3 | 6,16 | 1 | False = HIGH ;True = LOW |
| Ch 2 Alarm 2 On Delay | 43213 | 3 | 6,16 | 1 | Activation delay in seconds |
| Ch 2 Alarm 2 Off Delay | 43214 | 3 | 6,16 | 1 | Deactivation delay in minutes |
| Ch 2 Alarm 2 Hysteresis | 43215 | 3 | 6,16 | 1 | Percent of scale |
| Ch 2 Alarm 2 Color | 43216 | 3 | 6,16 | 1 | 0 = Red, 1 = Blue, 2 = Orange |
| Ch 2 Alarm 3 Latch | 43221 | 3 | 6,16 | 1 | False = NO; True = YES |
| Ch 2 Alarm 3 Trip | 43222 | 3 | 6,16 | 1 | False = HIGH ;True = LOW |
| Ch 2 Alarm 3 On Delay | 43223 | 3 | 6,16 | 1 | Activation delay in seconds |
| Ch 2 Alarm 3 Off Delay | 43224 | 3 | 6,16 | 1 | Deactivation delay in minutes |
| Ch 2 Alarm 3 Hysteresis | 43225 | 3 | 6,16 | 1 | Percent of scale |
| Ch 2 Alarm 3 Color | 43226 | 3 | 6,16 | 1 | 0 = Red, 1 = Blue, 2 = Orange |
| Ch 2 Alarm 3 Enabled | 43227 | 3 | 6,16 | 1 | False = NO; True = YES |
| Ch 2 Data From | 43231 | 3 | 6,16 | 1 | Selection |
| Ch 2 Min Raw | 43232 | 3 | 6,16 | 1 | Binary (800) |
| Ch 2 Max Raw | 43233 | 3 | 6,16 | 1 | Binary (4000) |
| Ch 2 Remote ID | 43234 | 3 | 6,16 | 1 | Binary |
| Ch 2 Interface | 43235 | 3 | 6,16 | 1 | Binary |
| Ch 2 Byte Order | 43236 | 3 | 6,16 | 1 | Byte order |
| Ch 2 Alias | 43237 | 3 | 16 | 2 | Binary; 32 bit; 2x |
| Ch 2 IP Address | 43239 | 3 | 6,16 | 2 | Binary; 4x unsigned bytes |
| Ch 2 Port | 43241 | 3 | 16 | 2 | Binary; 32 bit; 2x |
| Ch 2 Remote Sensor | 43243 | 3 | 6,16 | 1 | Binary |
| Ch 2 DP | 43279 | 3 | 6,16 | 1 | Number of decimal points |
| Ch 2 Enable | 43280 | 3 | 6,16 | 1 | False = NO; True = YES |
| Ch 2 Deadband | 43281 | 3 | 16 | 2 | Modbus 32 bit IEEE 754 Floating Pt |
| Ch 2 Marker Enable | 43283 | 3 | 6,16 | 1 | False = NO; True = YES |
| Ch 2 Marker Percent | 43284 | 3 | 16 | 2 | Modbus 32 bit IEEE 754 Floating Pt |
| Ch 2 Marker Info | 43286 | 3 | 6,16 | 3 | 6 ASCII characters |

| | | | | | |
|-----------------------|-------|---|------|---|------------------------------------|
| Ch 2 Marker Life | 43289 | 3 | 6,16 | 1 | Binary |
| Ch 2 Filter Count | 43290 | 3 | 6,16 | 1 | Binary ;0 to 60 |
| Ch 2 Radio Reg | 43291 | 3 | 6,16 | 1 | Binary |
| Ch 2 Coefficient | 43292 | 3 | 6,16 | 1 | Binary |
| Ch 2 Bridge Voltage | 43293 | 3 | 16 | 2 | Modbus 32 bit IEEE 754 Floating Pt |
| Ch 2 Balance | 43295 | 3 | 6,16 | 1 | Binary |
| Ch 2 Heater Enable | 43296 | 3 | 6,16 | 1 | False = NO; True = YES |
| Ch 2 Heater Setpoint | 43297 | 3 | 16 | 2 | Modbus 32 bit IEEE 754 Floating Pt |
| Ch 2 Temp Comp -40 | 43299 | 3 | 16 | 2 | 32 bit FP Gain ;32 bit FP Offset |
| Ch 2 Temp Comp -30 | 43303 | 3 | 16 | 2 | 32 bit FP Gain ;32 bit FP Offset |
| Ch 2 Temp Comp -20 | 43307 | 3 | 16 | 2 | 32 bit FP Gain ;32 bit FP Offset |
| Ch 2 Temp Comp -10 | 43311 | 3 | 16 | 2 | 32 bit FP Gain ;32 bit FP Offset |
| Ch 2 Temp Comp 0 | 43315 | 3 | 16 | 2 | 32 bit FP Gain ;32 bit FP Offset |
| Ch 2 Temp Comp +10 | 43319 | 3 | 16 | 2 | 32 bit FP Gain ;32 bit FP Offset |
| Ch 2 Temp Comp +20 | 43323 | 3 | 16 | 2 | 32 bit FP Gain ;32 bit FP Offset |
| Ch 2 Temp Comp +30 | 43327 | 3 | 16 | 2 | 32 bit FP Gain ;32 bit FP Offset |
| Ch 2 Temp Comp +40 | 43331 | 3 | 16 | 2 | 32 bit FP Gain ;32 bit FP Offset |
| Ch 2 Temp Comp +50 | 43335 | 3 | 16 | 2 | 32 bit FP Gain ;32 bit FP Offset |
| Ch 2 Temp Comp +60 | 43339 | 3 | 16 | 2 | 32 bit FP Gain ;32 bit FP Offset |
| Ch 2 Sensor Type CRC | 43343 | 3 | 6,16 | 1 | CRC of sensor type text |
| Ch 2 Send Sensor Life | 43344 | 3 | 6,16 | 1 | False = NO; True = YES |
| Ch 2 Cal mA Setting | 43345 | 3 | 16 | 2 | Modbus 32 bit IEEE 754 Floating Pt |
| Ch 2 Local Cal | 43347 | 3 | 6,16 | 1 | False = NO; True = YES |
| Ch 2 AI Range | 43348 | 3 | 6,16 | 1 | 0 = 0 - 20mA, 1 = 4-20mA |
| Ch 2 Initial Gain | 43349 | 3 | 6,16 | 2 | 8-bit Representation of Gain |
| Ch 1 Value | 45001 | 3 | 6,16 | 1 | 800 = "0"; 4000 = Full Scale |
| Ch 2 Value | 45002 | 3 | 6,16 | 1 | 800 = "0"; 4000 = Full Scale |
| Ch 1 Value | 45003 | 3 | 16 | 2 | MODBUS 32 bit floating point |
| Ch 2 Value | 45005 | 3 | 16 | 2 | MODBUS 32 bit floating point |
| Ch 1 Alarm 1 Status | 45007 | 3 | 6,16 | 1 | "1" = Fault |
| Ch 1 Alarm 2 Status | 45008 | 3 | 6,16 | 1 | "1" = Fault |
| Ch 1 Alarm 3 Status | 45009 | 3 | 6,16 | 1 | "1" = Fault |
| Ch 1 Fault Status | 45010 | 3 | 6,16 | 1 | "1" = Fault |
| Ch 2 Alarm 1 Status | 45011 | 3 | 6,16 | 1 | "1" = Fault |
| Ch 2 Alarm 2 Status | 45012 | 3 | 6,16 | 1 | "1" = Fault |
| Ch 2 Alarm 3 Status | 45013 | 3 | 6,16 | 1 | "1" = Fault |
| Ch 2 Fault Status | 45014 | 3 | 6,16 | 1 | "1" = Fault |
| Ch 1 Sensor Life | 45015 | 3 | 6,16 | 1 | 0-100 binary |

| | | | | | |
|------------------|-------|---|------|---|------------------------------|
| Ch 2 Sensor Life | 45016 | 3 | 6,16 | 1 | 0-100 binary |
| Ch 1 Sensor Temp | 45017 | 3 | 6,16 | 1 | Binary 0 - 4095 |
| Ch2 Sensor Temp | 45018 | 3 | 6,16 | 1 | Binary 0 - 4095 |
| Ch 1 Sensor Temp | 45019 | 3 | 16 | 2 | MODBUS 32 bit floating point |
| Ch 2 Sensor Temp | 45021 | 3 | 16 | 2 | MODBUS 32 bit floating point |

Chapter 6 Special Features

6.1 WEBPAGE

All SenSmart 6000 transmitters come standard with an embedded webpage. The webpage gives remote access to view and configure parameters inside the transmitter. The required login allows the user to change configuration parameters directly from the computer.

Webserver Login Information:

User name: admin

Password: transmitter2

The webpage requires a modern web browser. Supported browsers include Internet Explorer 8*, Google Chrome, or Mozilla Firefox 2+. Viewing pages in an outdated browser will result in improperly drawn pages.

In order to view the webpage first the user must know the IP address or, if DHCP enabled, the transmitter's hostname. This information can be viewed from the Network Settings Menu (see [Section 4.5.3](#)). The user will be able to see channel data, event logs and configuration. If a parameter needs to be changed the user must login before the transmitter will accept the change. This login password can be changed in the Security menu under Modbus/Web Code (see [Section 4.6](#)). The default Modbus/Web Code is **1234**.

* Internet Explorer does not allow access to hostnames that contain a '_' character.

6.1.1 STATUS SCREEN

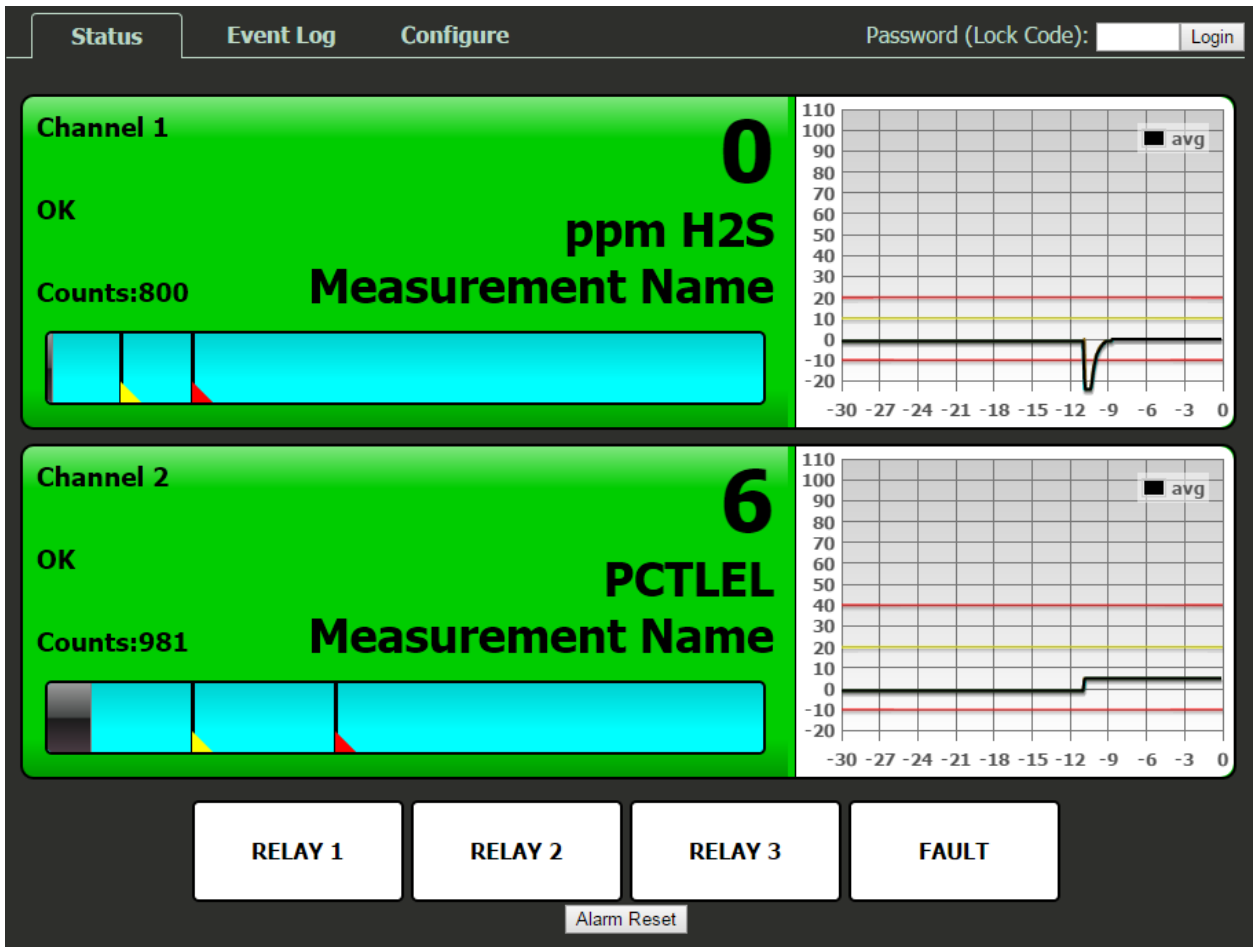

Figure 6-1 Status Screen

The **Status Screen** shown above (Figure 6-1) displays the active channels simultaneously depending on the transmitter's configuration. This screen, similar to the Dual Channel screen, displays the measurement name and reading, and uses colored cells that flash with new alarms to indicate alarm conditions. Once the alarms have been acknowledged by an operator, the cell will remain the appropriate color but will stop flashing, showing the alarm has been acknowledged.

The four alarm relay states are shown at the bottom of the screen. A red box indicates an energized (de-energized in fail safe) relay.

A thirty minute trend graph is viewable on the right hand side of the screen. Vertical tic marks are each 10% of full scale. Colored lines indicate alarm levels. Since each data point must be collected for several seconds before it may be displayed it is likely input values will fluctuate during this interval. In this case a light blue indicates a minimum value and a brown line indicates a maximum value.

The Status Screen is updated automatically every 15 seconds.

6.1.2 EVENT LOG SCREEN

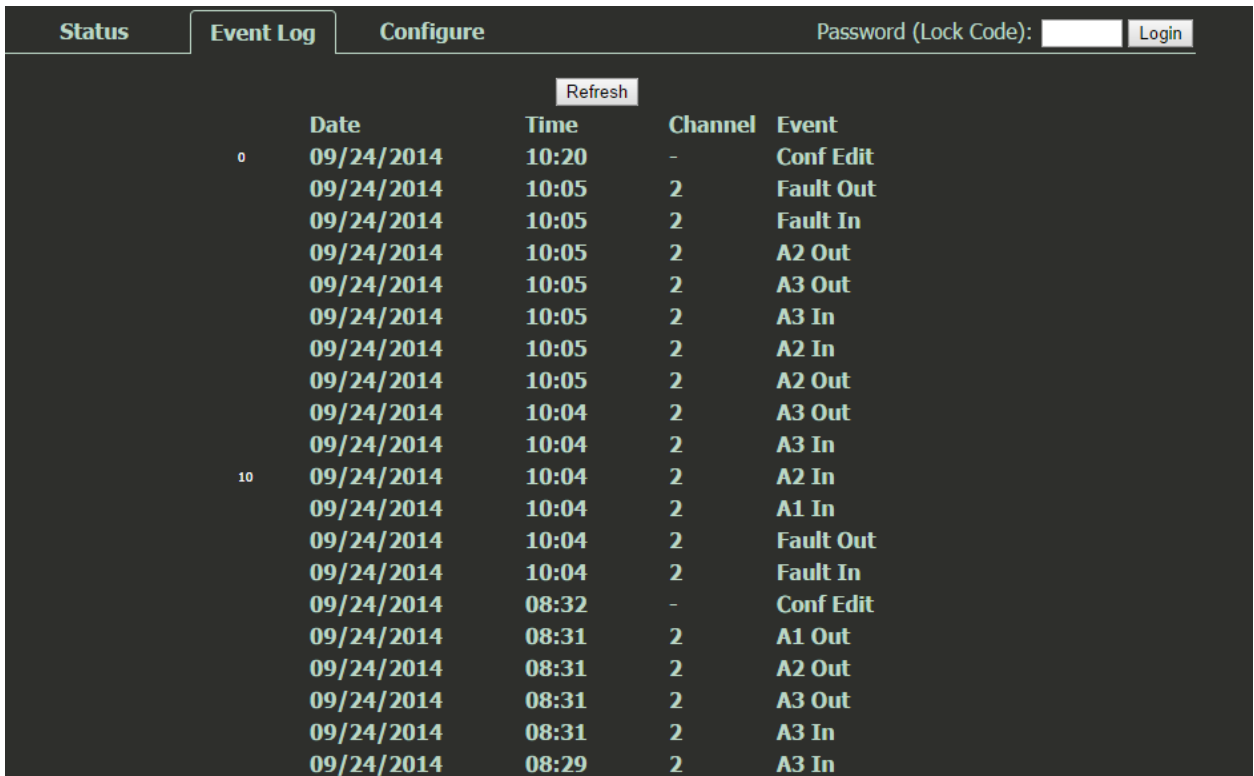

| | | Date | Time | Channel | Event |
|----|--|------------|-------|---------|-----------|
| 0 | | 09/24/2014 | 10:20 | - | Conf Edit |
| | | 09/24/2014 | 10:05 | 2 | Fault Out |
| | | 09/24/2014 | 10:05 | 2 | Fault In |
| | | 09/24/2014 | 10:05 | 2 | A2 Out |
| | | 09/24/2014 | 10:05 | 2 | A3 Out |
| | | 09/24/2014 | 10:05 | 2 | A3 In |
| | | 09/24/2014 | 10:05 | 2 | A2 In |
| | | 09/24/2014 | 10:05 | 2 | A2 Out |
| | | 09/24/2014 | 10:04 | 2 | A3 Out |
| | | 09/24/2014 | 10:04 | 2 | A3 In |
| 10 | | 09/24/2014 | 10:04 | 2 | A2 In |
| | | 09/24/2014 | 10:04 | 2 | A1 In |
| | | 09/24/2014 | 10:04 | 2 | Fault Out |
| | | 09/24/2014 | 10:04 | 2 | Fault In |
| | | 09/24/2014 | 08:32 | - | Conf Edit |
| | | 09/24/2014 | 08:31 | 2 | A1 Out |
| | | 09/24/2014 | 08:31 | 2 | A2 Out |
| | | 09/24/2014 | 08:31 | 2 | A3 Out |
| | | 09/24/2014 | 08:31 | 2 | A3 In |
| | | 09/24/2014 | 08:29 | 2 | A3 In |

Figure 6-2 Event Log Screen

The **Event Log Screen** displays the last 100 events logged in the SenSmart 6000. The events are logged in a first in first out format, in non-volatile memory.

Logged events include:

1. Alarms/Fault In and Out
2. Alarm and Remote Alarm Resets
3. Alarm Refresh
4. Event Log Cleared
5. Configuration Changed
6. Calibration in and out
7. System and Cold Boots
8. Communication and Configuration Errors
9. Corrupt Sensor
10. Sensor Error
11. Configuration Edits

The events are time and date stamped and if channel specific the number of the channel is shown in the third column in Figure 6-2 above.

6.1.3 CONFIGURE

The configuration pages allow viewing and editing of most system parameters. The exceptions are communication and security settings which must be set from the unit's magnetic switch interface. All changes made to the parameters will not be saved until the user has entered the correct login password.

6.1.3.1 RELAY CONFIG

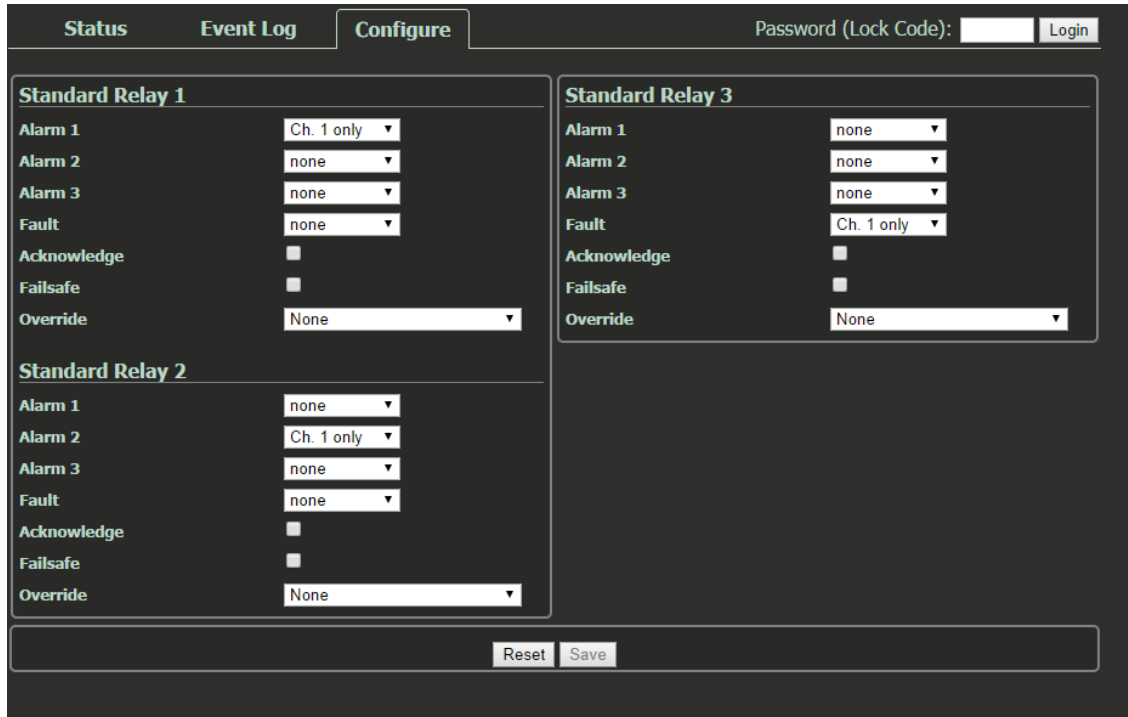

The screenshot shows the 'Configure' tab of the user interface. At the top right, there is a 'Password (Lock Code):' field and a 'Login' button. The main area is divided into three sections for 'Standard Relay 1', 'Standard Relay 2', and 'Standard Relay 3'. Each section contains the following settings:

- Standard Relay 1:** Alarm 1 (Ch. 1 only), Alarm 2 (none), Alarm 3 (none), Fault (none), Acknowledge (checkbox), Failsafe (checkbox), Override (None).
- Standard Relay 2:** Alarm 1 (none), Alarm 2 (Ch. 1 only), Alarm 3 (none), Fault (none), Acknowledge (checkbox), Failsafe (checkbox), Override (None).
- Standard Relay 3:** Alarm 1 (none), Alarm 2 (none), Alarm 3 (none), Fault (Ch. 1 only), Acknowledge (checkbox), Failsafe (checkbox), Override (None).

At the bottom of the configuration area, there are 'Reset' and 'Save' buttons.

Figure 6-3 Relay Config Screen

The **Relay Config Screen** is shown in Figure 6-3. For information on how to configure the relays, refer to [Section 4.3](#).

6.1.3.2 CHANNEL CONFIG

Status
Event Log
Configure
Loading...
Password (Lock Code):

1 ▾
Ch. Down
Ch. Up

Alarm 1

Setpoint

Latching

Trip On

On Delay (seconds)

Off Delay (minutes)

Deadband (%)

Alarm 2

Setpoint

Latching

Trip On

On Delay (seconds)

Off Delay (minutes)

Deadband (%)

Color

Alarm 3

Enabled

Setpoint

Latching

Trip On

On Delay (seconds)

Off Delay (minutes)

Deadband (%)

Color

Temperature Compensation

| Gain | Offset | |
|------------------------------------|------------------------------------|-------|
| <input type="text" value="1.100"/> | <input type="text" value="0.000"/> | -40°C |
| <input type="text" value="1.100"/> | <input type="text" value="0.000"/> | -30°C |
| <input type="text" value="1.100"/> | <input type="text" value="0.000"/> | -20°C |
| <input type="text" value="1.080"/> | <input type="text" value="0.000"/> | -10°C |
| <input type="text" value="1.050"/> | <input type="text" value="0.000"/> | -00°C |
| <input type="text" value="1.030"/> | <input type="text" value="0.000"/> | 10°C |
| <input type="text" value="1.000"/> | <input type="text" value="0.000"/> | 20°C |
| <input type="text" value="0.990"/> | <input type="text" value="0.200"/> | 30°C |
| <input type="text" value="0.970"/> | <input type="text" value="0.300"/> | 40°C |
| <input type="text" value="0.960"/> | <input type="text" value="1.000"/> | 50°C |
| <input type="text" value="0.980"/> | <input type="text" value="1.000"/> | 60°C |

Configure

Channel Enabled

Tag

Engineering Units

Zero

Span

Decimal Places

Deadband (%)

In Cal Output (mA)

Data From

Source

Remote

Min Raw

Max Raw

Filter Count (seconds)

Heater Enable

Heater Setpoint

Fault

Fault Setpoint

Ch. Down
Ch. Up

Figure 6-4 Channel Config Screen

The **Channel Config Screen** is shown in Figure 6-4. For information on how to configure channels refers to [Section 4.4](#).

6.1.3.3 SYSTEM CONFIG

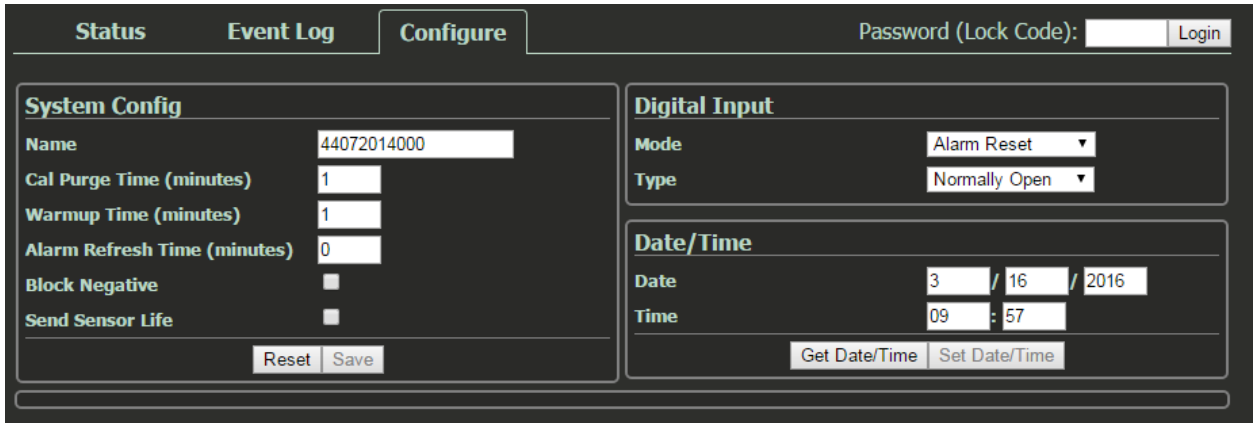

The screenshot shows the 'Configure' tab selected. At the top right, there is a 'Password (Lock Code):' field and a 'Login' button. The main content area is divided into three sections:

- System Config:**
 - Name: 44072014000
 - Cal Purge Time (minutes): 1
 - Warmup Time (minutes): 1
 - Alarm Refresh Time (minutes): 0
 - Block Negative:
 - Send Sensor Life:
- Digital Input:**
 - Mode: Alarm Reset
 - Type: Normally Open
- Date/Time:**
 - Date: 3 / 16 / 2016
 - Time: 09 : 57

Buttons for 'Reset' and 'Save' are located at the bottom of the System Config section. 'Get Date/Time' and 'Set Date/Time' buttons are at the bottom of the Date/Time section.

Figure 6-5 System Config Screen

The **System Config Screen** is shown in Figure 6-5. For information on how to configure the system, refer to [Section 4.7](#).

6.1.3.4 COMM CONFIG

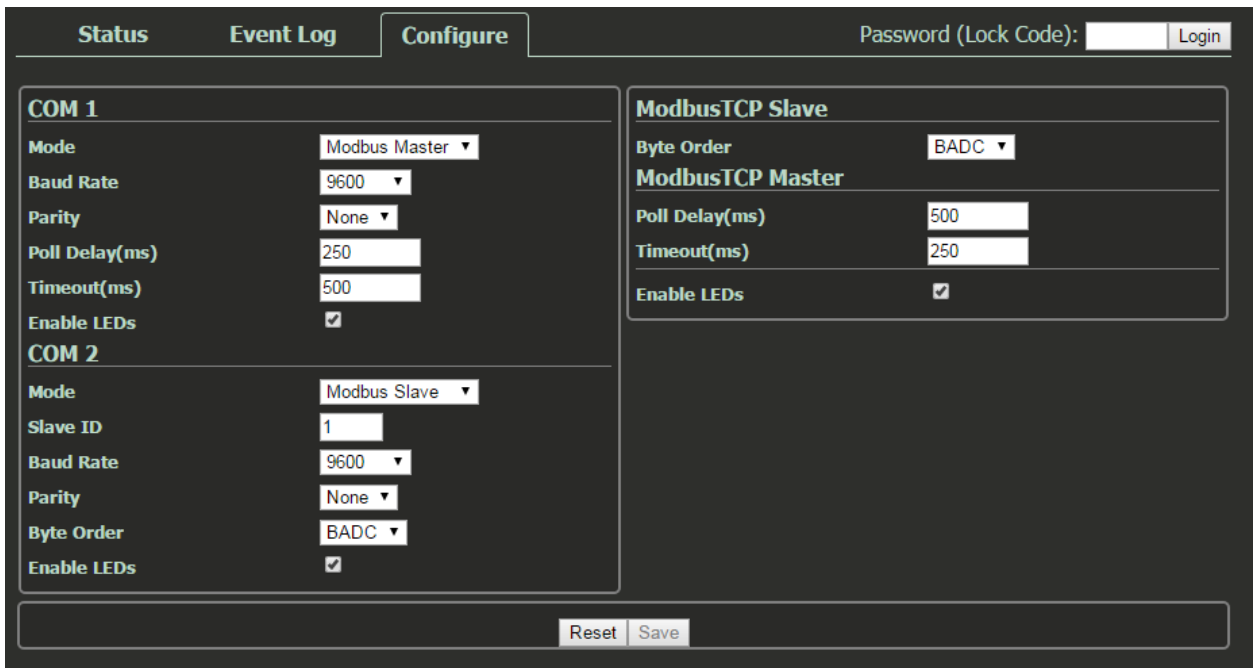

The screenshot shows the 'Configure' tab selected. At the top right, there is a 'Password (Lock Code):' field and a 'Login' button. The main content area is divided into four sections:

- COM 1:**
 - Mode: Modbus Master
 - Baud Rate: 9600
 - Parity: None
 - Poll Delay(ms): 250
 - Timeout(ms): 500
 - Enable LEDs:
- COM 2:**
 - Mode: Modbus Slave
 - Slave ID: 1
 - Baud Rate: 9600
 - Parity: None
 - Byte Order: BADC
 - Enable LEDs:
- ModbusTCP Slave:**
 - Byte Order: BADC
- ModbusTCP Master:**
 - Poll Delay(ms): 500
 - Timeout(ms): 250
 - Enable LEDs:

'Reset' and 'Save' buttons are located at the bottom center of the screen.

Figure 6-6 Comm Config Screen

The **Comm. Config Screen** allows configuration of Comm Ports 1 and 2 and Modbus TCP. For more information on how to configure these options refer to [Section 4.5](#).

6.1.3.5 CONFIG TRANSFER

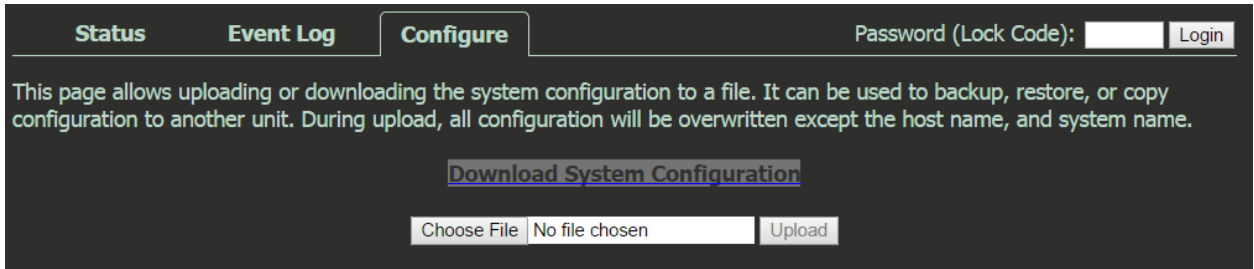

Figure 6-7 Config Transfer Screen

The **Config Transfer Screen**, Figure 6-6, allows the transferring of system configuration to or from the unit via the webpage. When the download link is clicked, the unit saves the current configuration into a file and transfers it to the user. It should be save as a .cfg file. When uploading configuration, select a .cfg file and press upload. Note that the maximum length of a filename for an uploaded file is 28 characters. After a successful upload, the unit will restart and the webpage will attempt to refresh after 30 seconds.

6.2 NETWORK CONNECTION

6.2.1 DIRECT CONNECTION WITH CROSSOVER CABLE OR HUB/SWITCH

If a network is not available, or if it is desired to keep the SenSmart 6000 and PC(s) completely separated from other computer, a simple network can be created.

The simplest network can be created by connecting the SenSmart 6000 to a PC directly using an Ethernet crossover cable. Many modern computers have automatic detection/switching on the port. In most cases a normal patch cable can directly connect the SenSmart 6000 to a PC.

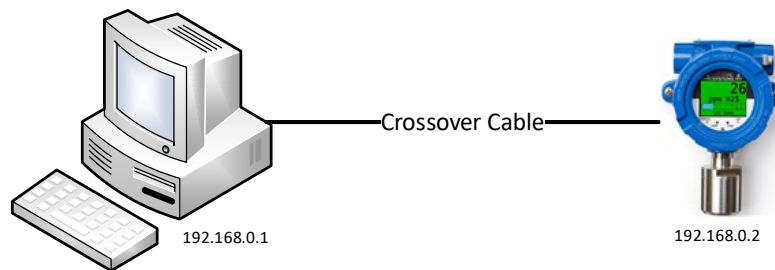

Figure 6-8 Direct Connection with Crossover Cable

If a crossover cable is not available, or if multiple computers need access to the SenSmart 6000, a switch can be connected to the SenSmart 6000 and one or more computer using standard patch cables.

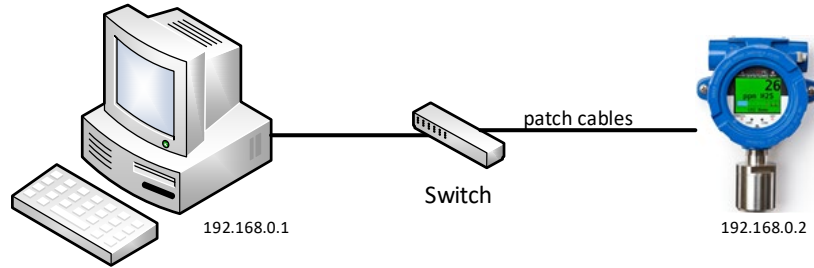

Figure 6-9 Direct Connection with Switch and Patch Cables

These simple networks will not likely have access to a DHCP server. In this case, if the SenSmart 6000 is configured for DHCP, it will automatically select an IP address on the subnet 169.254.x.x. This subnet uses a netmask of 255.255.0.0 and is compatible with the default IP address chosen by Microsoft Windows. Simply connect the PC with a patch cable. Then view the SenSmart 6000 'Communication Settings'-'Network Settings' Menu. The IP address field will show a value which can be entered into the web browser to view the webpage.

The recommended option for a permanent network is to set up a static IP on the SenSmart 6000 and any other devices (or computers) on the network (See [Section 6.2.4](#)).

6.2.2 CONNECTING THE SENSMART 6000 TO AN EXISTING LAN

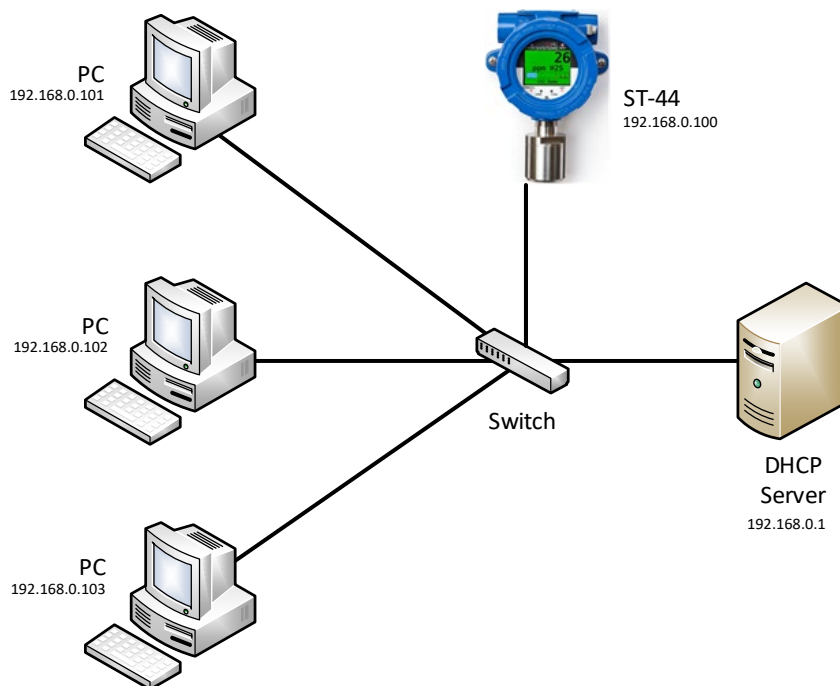

Figure 6-10 Connecting the SenSmart 6000 to an Existing LAN

A typical network will have a DHCP server, a switch (sometimes combined) and several devices connected to that switch. An SenSmart 6000 can normally be added to such a network simply by connecting the Ethernet port to the switch using an Ethernet patch cable. The SenSmart

6000's default settings will allow it to obtain an IP address from the DHCP server. Once this happens, the SenSmart 6000 can be accessed from computers and other devices on the network. Computers access the SenSmart 6000 by hostname, or by IP address.

If more than one SenSmart 6000 is on the network, and if they need to communicate with each other, it is recommended to use a static IP configuration (see [Section 6.2.4](#)). This is because there is a possibility that a dynamic address will be changed by the DHCP server. If the IP address is changed, communication will fail. Static configuration is necessary when using ModbusTCP master or slave mode over TCP/IP.

If accessing the SenSmart 6000 from a computer or other device that can resolve its hostname, dynamic configuration is fine.

6.2.3 CONNECTING THE SENSMART 6000 TO AN ISOLATED NETWORK

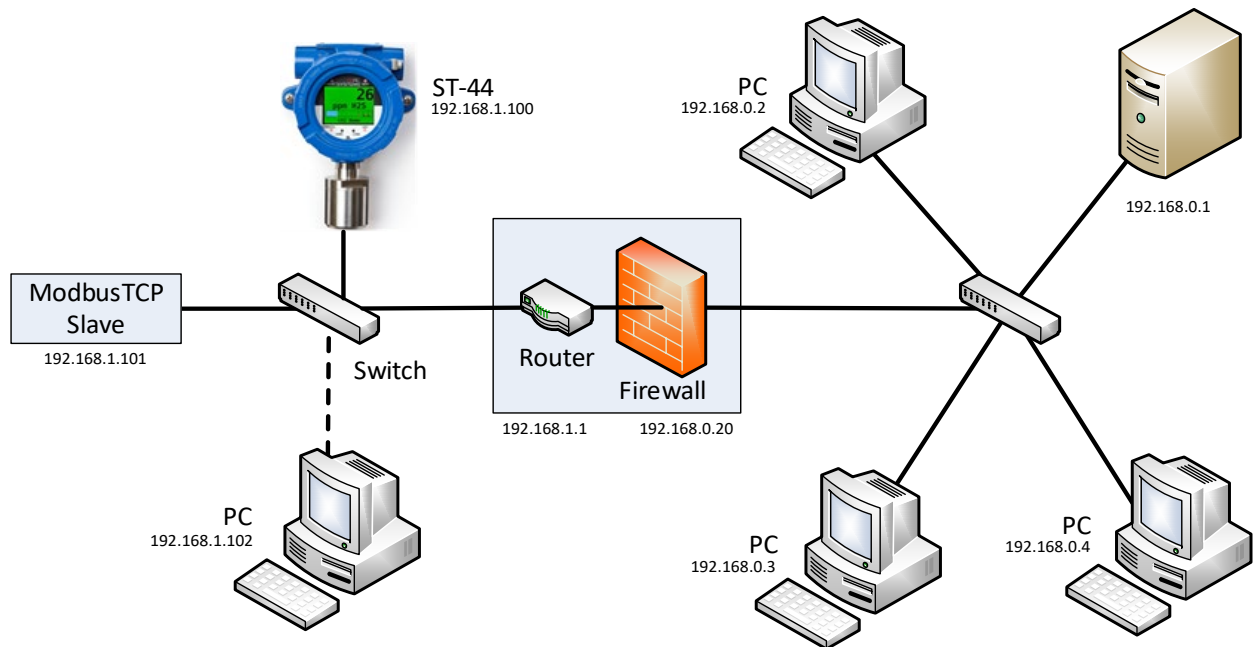

Figure 6-11 Connecting the SenSmart 6000 to an Isolated Network

Another possible network configuration for the SenSmart 6000 involves connecting the transmitter, with ModbusTCP slave devices, and possibly computers on a network. This network can then be isolated from a larger company network using a router/firewall. The isolated network will not see any traffic from the company network unless port forwarding rules are set up in the router. This configuration offers greater security and improved network performance when the company network has a large amount of traffic.

When creating an isolated network, make sure to use a different private IP address range than the outside network. For example, if the main network uses 192.168.0.0 – 192.168.0.255 with a netmask of 255.255.255.0, the isolated network could use 1.9.168.1.0 – 192.168.1.255 with the same netmask.

Port forwarding rules can usually be configured to only allow certain computers outside the firewall access to the SenSmart 6000. The method for creating forwarding rules is heavily dependent on the router/firewall being used. See router documentation. The IP address or MAC address of the source (outside computer), Incoming port, destination (SenSmart 6000) IP address, destination port, and protocol will need to be set. The source IP address should be set to allow a range or single IP address. Some firewalls can restrict access by MAC address. This can be used instead of or in addition to the source IP address. The protocols for forwarding rules should be TCP/IP. The destination ports should be 80 for access to the web server, and 502 for access to ModbusTCP.

In most cases, a router and firewall will separate the network from the internet. It is not recommended to forward ports from the internet to an SenSmart 6000. In cases where offsite access is needed, a VPN, or tunnel, connection could be used to get inside the network.

6.2.4 STATIC IP CONFIGURATION

If you are setting up a Static IPs on a larger company network, make sure to consult your IT administrator to obtain an IP address. The IT administrator can also provide the correct netmask, and gateway. In this case, do not choose your own addresses or you could cause an address conflict with other devices on the network.

6.2.4.1 SENSMART 6000 STATIC IP CONFIGURATION

On the SenSmart 6000, in the Network Settings Menu, disable DHCP. The IP address should be set to 192.168.0.x where 'x' is any number from 0 to 255. A typical address would be 192.168.0.76. The netmask should be set to 255.255.255.0. The gateway can be left as 0.0.0.0 unless the SenSmart 6000 will be accessing ModbusTCP devices outside a router/firewall. If the SenSmart 6000 needs to poll outside, devices, the gateway IP should be set. This is typically the IP address of a router.

| Network Settings | |
|------------------|-----------------|
| DHCP Enabled | Yes |
| Host name | Unit - 44- 1000 |
| Ip Address | 192. 168. 0. 76 |
| Net mask | 255. 255. 0. 0 |
| Gateway | 0. 0. 0. 0 |

Figure 6-12 Network Settings Menu



After making changes to the Network Settings Menu, a power cycle is required. Make sure to exit the menu before cycling power so that the changes are saved.

6.2.4.2 WINDOWS XP STATIC IP CONFIGURATION

These steps are similar but not exactly the same in other versions of Windows.

To connect a PC to a SenSmart 6000 using static IP configuration, the PC must also be configured. First, access the PC's network adapter settings. In Windows XP, this can be found in the Control Panel -> Network Connections. Open the network adapter which is usually called 'Local Area Connection'.

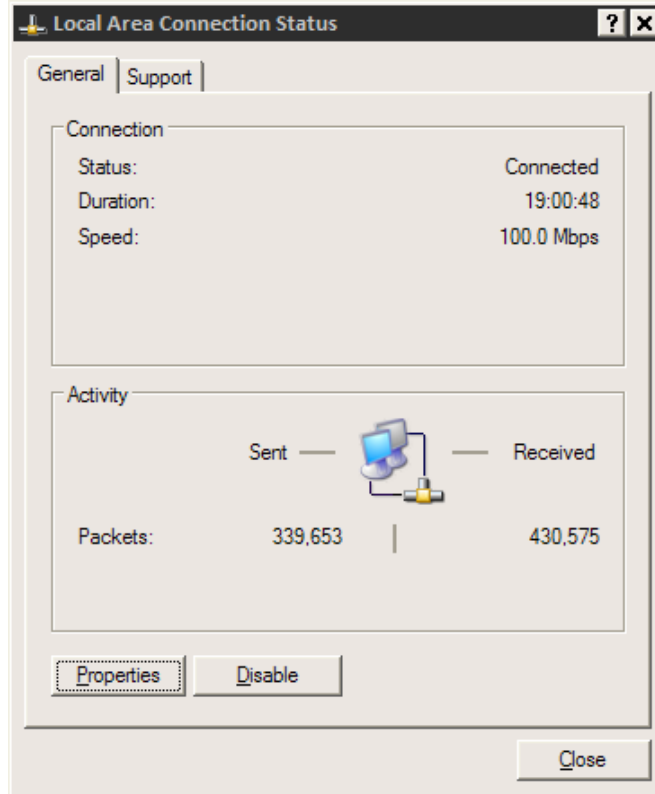

Figure 6-13 Local Area Connection

Click the Properties button.

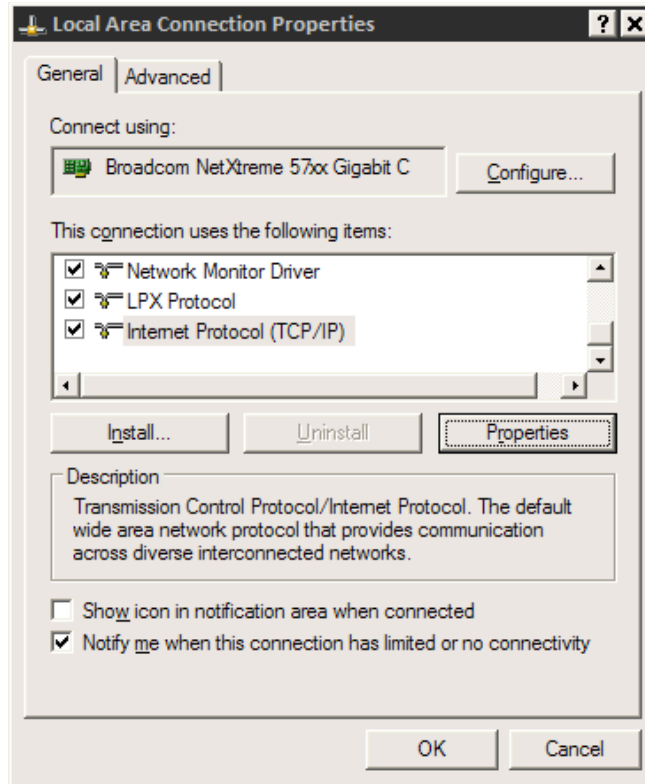

Figure 6-14 Local Area Connection Properties

Select "Internet Protocol (TCP/IP), and then click the Properties button.

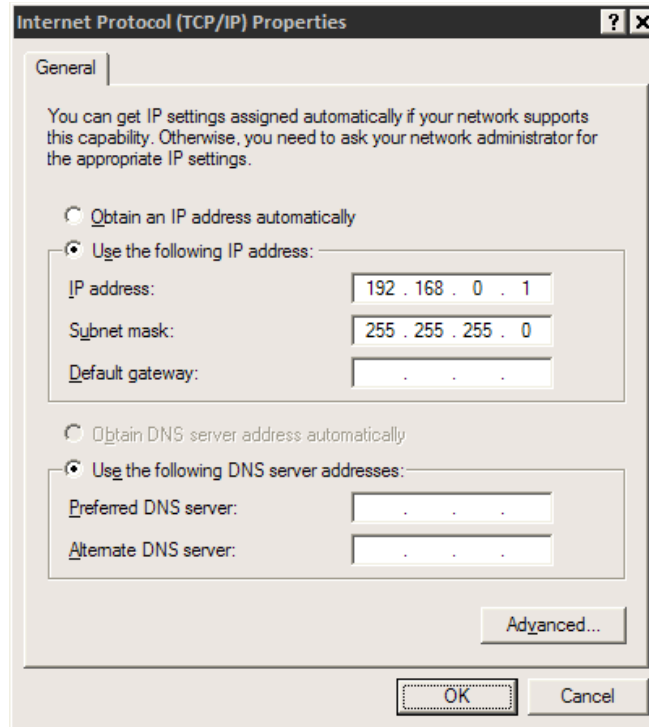
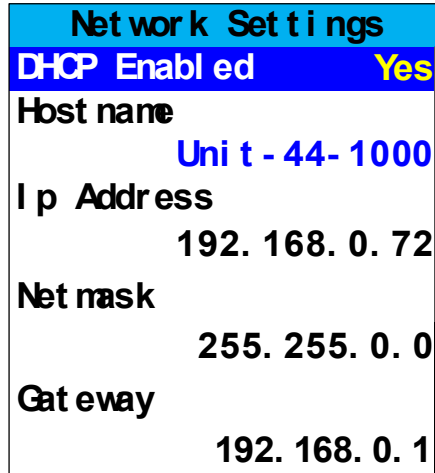

Figure 6-15 Internet Protocol (TCP/IP) Properties

Select "Use the following IP Address". The IP address should be chosen different than the one set on the SenSmart 6000. For the network created in the 'SenSmart 6000 Static IP Configuration', only the last digit can be changed. A typical choice is 192.168.0.1. The subnet mask is set to 255.255.255.0. If a gateway is present, its address should be set; otherwise it can be left blank. Click OK, and the OK again to apply these changes.

6.2.4.3 DYNAMIC IP CONFIGURATION

The SenSmart 6000 defaults to use a dynamic IP address. This setting may be used if a DHCP server is available on the network. It is recommended for SenSmart 6000s unless there are multiple SenSmart 6000s that need to communicate to each other.



| Network Settings | |
|------------------|-----------------|
| DHCP Enabled | Yes |
| Host name | Unit - 44- 1000 |
| Ip Address | 192. 168. 0. 72 |
| Net mask | 255. 255. 0. 0 |
| Gateway | 192. 168. 0. 1 |

Figure 6-16 Network Settings Menu with DHCP Enabled

To enable dynamic IP, set DHCP to Yes in the Network Settings Menu. Power must be cycled before this change takes effect. Make sure to exit the menu so the settings are saved before cycling power.

A PC will normally have DHCP enabled by default. If not, follow the steps in [Section 6.2.4.2](#), except choose "Obtain IP Address Automatically" in the last step.

6.2.5 TESTING CONNECTIONS

To verify that an SenSmart 6000 is accessible, bring up a command prompt. In Windows, this can be found by going to 'Start' -> 'Run'. Then type 'cmd' and press ok. From the command prompt, type ping and then the IP address of the unit. Verify that the 4 reply lines are printed.

6.3 10-0388 RELAY/RS 485 OPTION BOARD

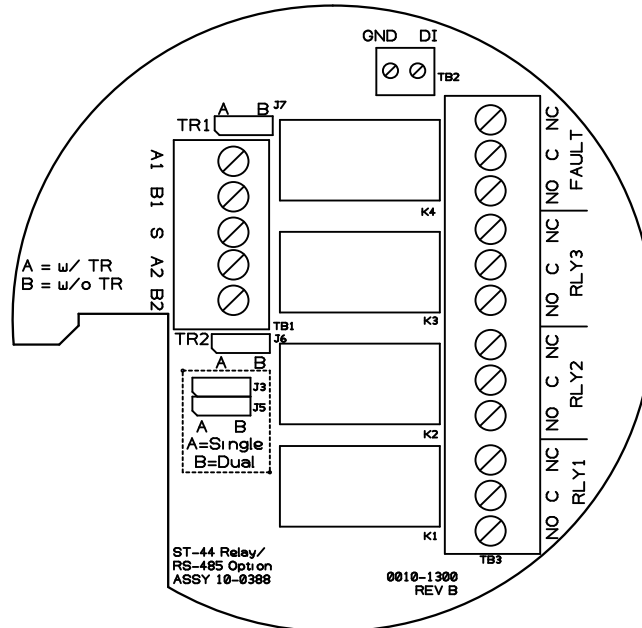

Figure 6-17 10-0388 Relay/RS-485 Option Board

The 10-0388 Relay/RS-485 Option Board comes equipped with the following features:

1. (2) RS-485 Modbus Communication ports
2. (3) Programmable relays
3. Dedicated Fault Relay
4. Digital Input

The 10-0388 is installed as a "piggyback" board on the back of the SenSmart 6000's 10-0387 CPU/Display Board.

6.3.1 RS-485 MODBUS COMMUNICATIONS PORTS

The two available Modbus Communication ports may be configured to work as a single port or two independent ports by positioning J3 and J5 to the desired position. When the jumpers are installed in the A, or "Single", position, the two ports are tied together to form a single port, e.g. A1 = A2 and B1 = B2. When the jumpers are installed in the B, or "Dual", position, the two ports function independently A1 with B1 and A2 with B2.

Each communication port is configured independently as discussed in [Section 4.5.1](#). For details on Modbus Slave Registers refer to [Chapter 5](#).

RS-485 Modbus networks should be wired as shown in Figure 6-17. Each SenSmart 6000 represents an RTU, and must have a unique Remote ID address. Remote ID addresses are assigned in the Data From Menus discussed in [Section 4.4.1.3](#). Cabling must be a daisy chain as opposed to a star pattern for reliable operation. The "end of line" unit should have J6 and J7 installed in the A position.

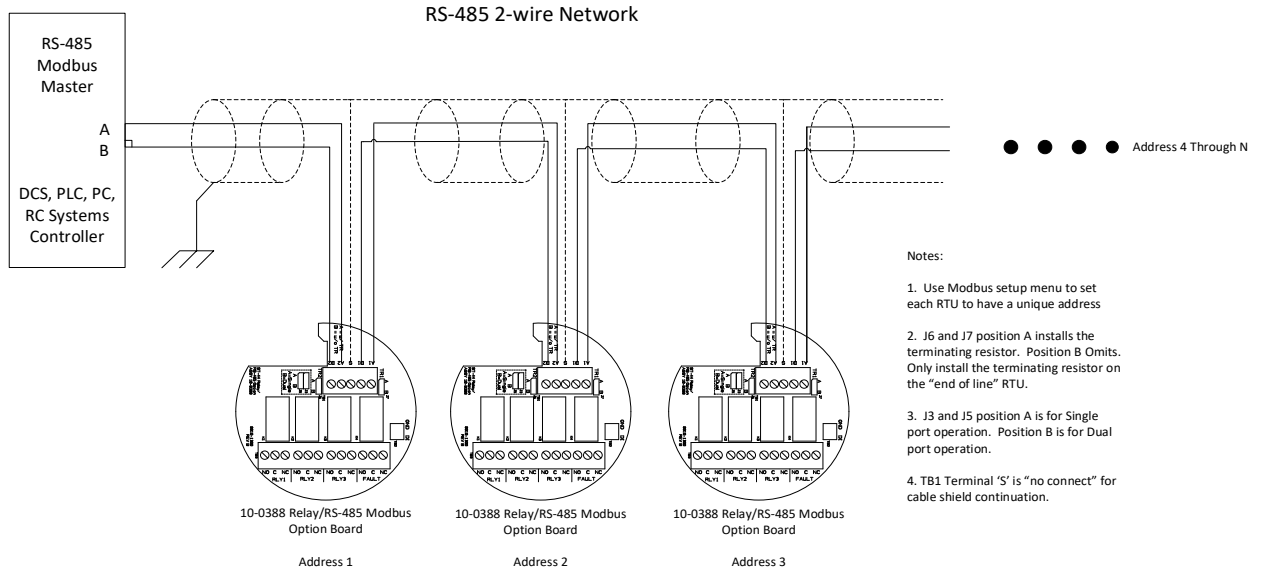

Figure 6-18 RS-485 Modbus Wiring

A convenient diagnostics tool is available to determine proper port operation, and is discussed in [Section 4.8.5.4](#).

6.3.2 PROGRAMMABLE RELAYS



Caution: Alarm relays have dry contacts and power must be supplied from an external source. If this power source exceeds 3 amps, users should consider fusing relay wiring with 3 amp fuses. Contacts are rated for RESISTIVE loads! Inductive loads, such as contactor coils or motors, may cause contact arcing. This will shorten life and emit RFI into the sensor signals. Use appropriate arcing snubber and MOVs across inductive loads, and keep wiring away from signal wires. External wiring to TB2 should be shielded and protected from noise spikes to prevent false alarm resets or overrides.

The relays installed on the 10-0388 are Relays are rated as form C 5AMP @ 30VDC and 240VAC RESISTIVE type relays.

Relay terminals are labeled NO (Normally Open), NC (Normally Closed) or C (Common, or pole). These designators correspond to the shelf, or de-energized, state of the relays.

The three programmable relays are configured either locally at the SenSmart 6000 or remotely using the embedded webpage. To configure the relays locally at the SenSmart 6000 transmitter refer to [Section 4.3.1](#). To configure the relays via the embedded webpage refer to [Section 6.1.3.1](#). A convenient diagnostics tool is available for testing relay wiring and operation, and is discussed in [Section 4.8.1](#).

6.3.3 FAULT RELAY



Caution: Alarm relays have dry contacts and power must be supplied from an external source. If this power source exceeds 3 amps, users should consider fusing relay wiring with 3 amp fuses. Contacts are rated for RESISTIVE loads! Inductive loads, such as contactor coils or motors, may cause contact arcing. This will shorten life and emit RFI into the sensor signals. Use appropriate arcing snubber and MOVs across inductive loads, and keep wiring away from signal wires. External wiring to TB2 should be shielded and protected from noise spikes to prevent false alarm resets or overrides.

6.3.4 DIGITAL INPUT

External wiring to the Digital Input should be shielded and protected from noise spikes to prevent false signals.

Configuration for the Digital input is discussed in [Section 4.7.3](#), where the input can be set up to be used for Alarm Reset, Alarm 3 Override and Fault Override functions.

6.4 10-2080 REMOTE SENSOR OPTION BOARD

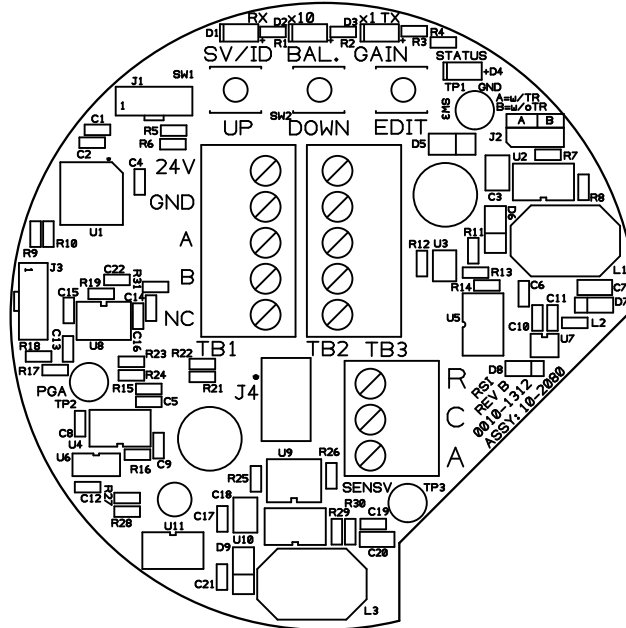

Figure 6-19 10-2080 Remote Sensor Option Board

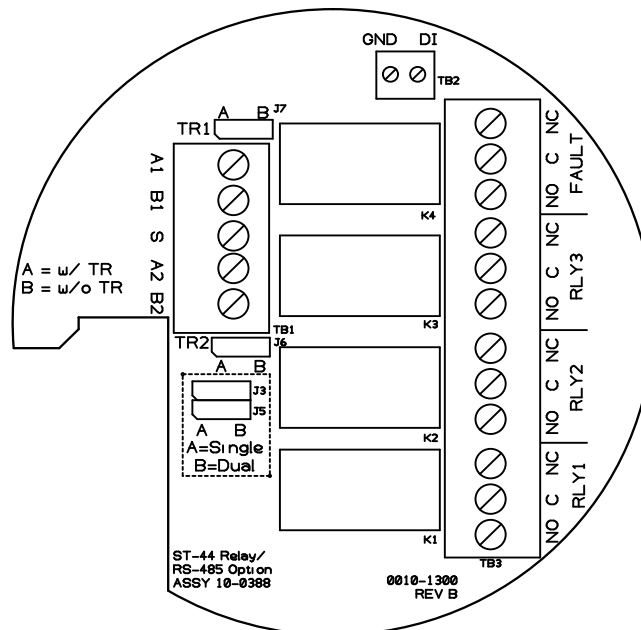
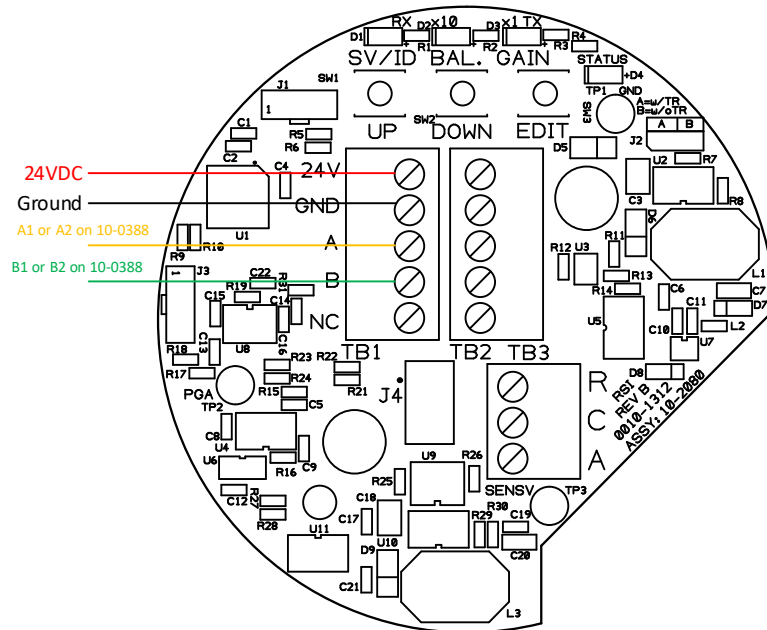

Figure 6-20 10-0388 Relay/RS-485 Option Board

Use of the 10-2080 Remote Sensor Option Board (Figure 6-19) requires the SenSmart 6000 to be equipped with a 10-0388 Relay/RS-485 Option Board (Figure 6-20). The Remote Sensor Option Board communicates to the SenSmart 6000 by utilizing one of the two RS-485 Communication Ports located on the Relay/RS-485 Option Board.

6.4.1 WIRING THE 10-2080 REMOTE SENSOR OPTION BOARD



Connect 24VDC and Ground wires to the 24V and GND terminals on TB1 or TB2 of the Remote Sensor Option Board to supply the necessary 24V. Connect the A and B terminals of TB1 or TB2 of the Remote Sensor Option Board to the A and B terminals of either Comm Port 1 or 2 of TB1 on the Relay/RS-485 Option Board.

6.4.2 REMOTE SENSOR SETUP

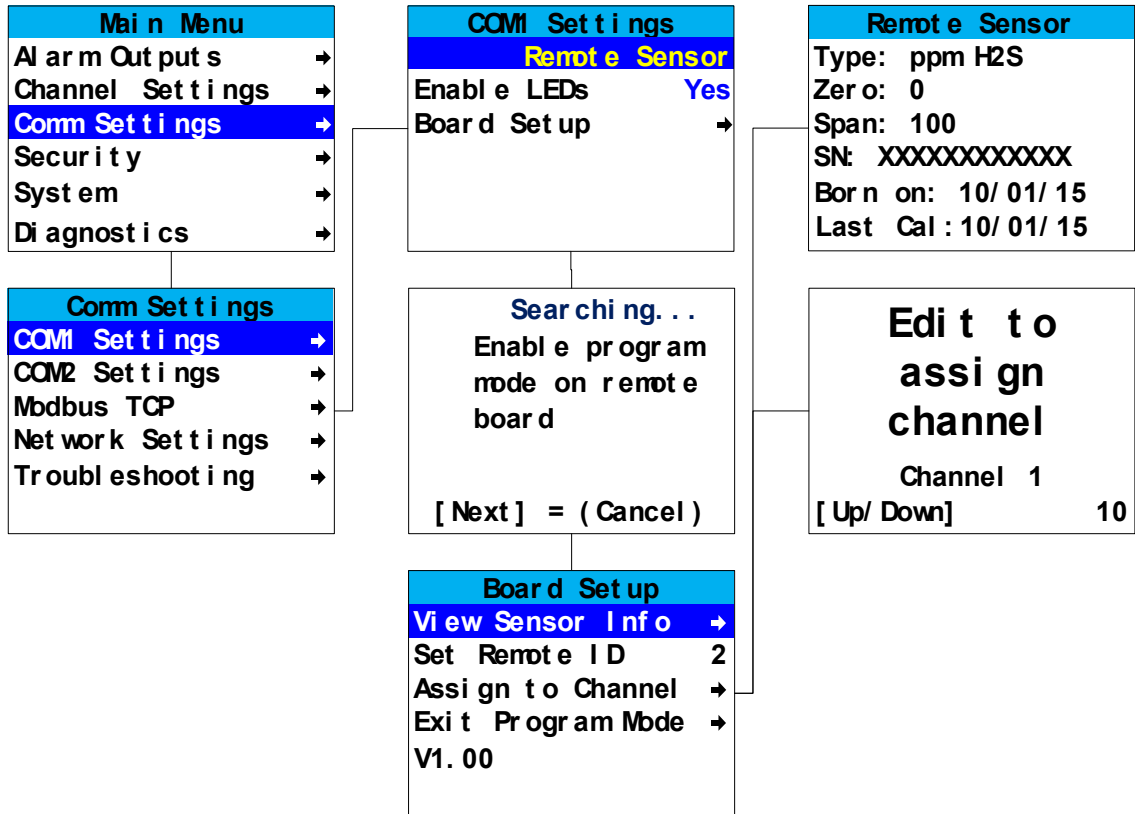

Figure 6-21 Remote Sensor Setup Menus

To set up the remote sensor, enter the Comm Settings menu to the Comm port the Remote Sensor is wired to (COM1 and COM2 Settings Menus are identical). Swipe the edit key until Remote Sensor is selected. Highlight the Board Setup menu option and swipe the Edit key. The SenSmart 6000 will begin searching for the Remote Sensor Option Board. To put the Remote Sensor Option Board in Setup Mode, press and hold the Edit key located at the top of the board, until the SenSmart 6000 enters the Board Setup Menu and the ID LED on the Remote Sensor Option Board begins slowly fading in and out.

To complete the setup process, set the Remote ID to a value between 1 and 247, assign the remote sensor to Channel 1 or 2 and select Exit Program Mode.



NOTE: Swiping the Next key will exit the Board Setup Menu, however, it will not exit the Remote Sensor Option Board from Setup Mode. This means the board will not enter normal Modbus communication. To properly exit the setup mode the Exit Program Mode menu option MUST be selected.

6.4.2.1 BOARD SETUP MENU

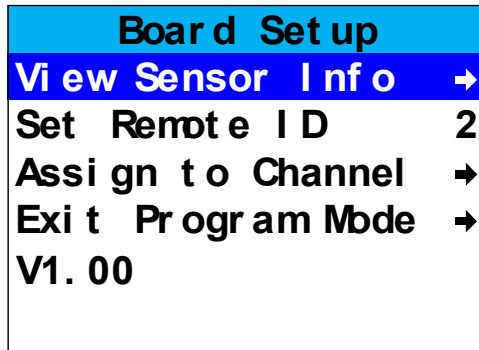

Figure 6-22 Board Setup Menu

The Board Setup Menu allows viewing sensor info for the sensor which is installed on the Remote Sensor Option Board, setting of the remote ID, assigning the remote sensor to channel 1 or channel 2 and viewing of the firmware version on the Remote Sensor Option Board.

6.4.2.2 VIEW SENSOR INFO MENU

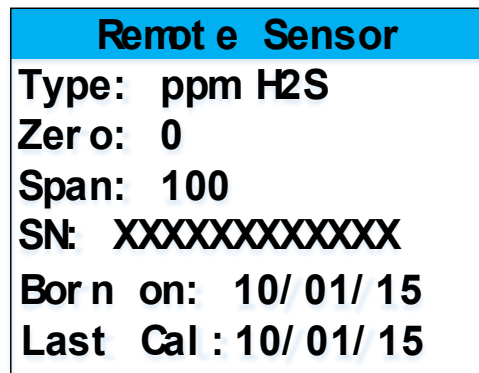

Figure 6-23 View Sensor Info Screen

Sensor Info includes the sensor's Type, Zero and Span values, Serial Number, Born on Date and the Date when the last Calibration was performed.

6.4.2.3 ASSIGN TO CHANNEL MENU



Figure 6-24 Assign to Channel Menu

To change the assigned channel for the remote sensor, swipe the UP or DOWN keys to cycle between Channel 1 and Channel 2. When the desired channel is shown, swipe the Edit key to assign the remote sensor to that channel.

Chapter 7 – Millenium Sensor Calibration

The R.C. Systems Inc. MILLENIUM is factory calibrated zeroed and spanned. *Unlike catalytic sensors it does not require routine span gas calibration to ensure proper operation.*

The R.C. Systems Inc. MILLENIUM can be calibrated for almost any hydrocarbon using a calibration gas of the hydrocarbon that is to be detected (target gas). The R.C. Systems Inc. MILLENIUM is required to be spanned with gas only one time with the target gas. Typically this is done at the factory, but it is possible to field span the device by connecting the R.C. Systems Inc. MILLENIUM to a computer and using a software package provided by R.C. Systems Inc.. Please contact the factory for further details.

A typical field calibration only requires the use of zero air (or 99.99% nitrogen). *If the sensor is located in an area that is known to be free of the hydrocarbon gases then ambient air can be used as a zero reference.*

If zero air is used for the calibration, there is a fitting on the bottom of the sensor for a 1/8" ID tubing connection.

Before beginning calibration use the R.C. Systems Inc. MILLENIUM Insulation Tube to cover outer cylinder holes and connect a clean air source to the sensor's calibration port for a minimum of 3 minutes. To enter into the calibration mode the calibration wire must be connected to negative (common of the power supply) for ten (10) seconds, upon release the sensor will automatically enter the zero calibration routine. The electronics will automatically adjust the sensor's signal to the new zero reference level. (Applying span gas is not necessary because of the R.C. Systems Inc. MILLENIUM's unique software algorithms). During the zero calibration routine, the current output of the R.C. Systems Inc. MILLENIUM will go to 2.2 mA. Although this can be accomplished manually, installation of a switch (contact closure) can accomplish the zeroing procedure. It is recommended that this switch be a momentary type switch to prevent it from inadvertently being left in the calibrate position. If after 20 seconds the calibration lead has not been removed from common, the R.C. Systems Inc. MILLENIUM will ignore the signal and continue operation as normal.

The R.C. Systems Inc. MILLENIUM can be spanned in the field if the customer wishes to change the target hydrocarbon gas. Please contact factory for additional equipment information and pricing for R.C. Systems Inc. PC IR Link Package)

SenSmart 6000 SmartCal

The MILLENIUM may also be supplied with the SenSmart 3000 or 6000 sensor transmitters to add features such as graphic readout, Modbus, alarm relays and even a second electrochemical sensor for oxygen or toxic gas detection. In this case, the 3300M / 6300M is equipped with an integral reed switch to offer "SmartCal" without opening the XP enclosure.

IMPORTANT: Make certain the MILLENIUM is exposed to zero gas or ambient gas free of the hydrocarbon gas to be detected.

With zero gas on the MILLENIUM as described in Chapter 4 above, hold the flat surface of the magnet supplied with the 6300M adjacent to the horseshoe magnet symbol shown in the picture below FOR 10 SECONDS. This will perform the SmartCal because the internal reed switch will short the SmartCal wire to common.

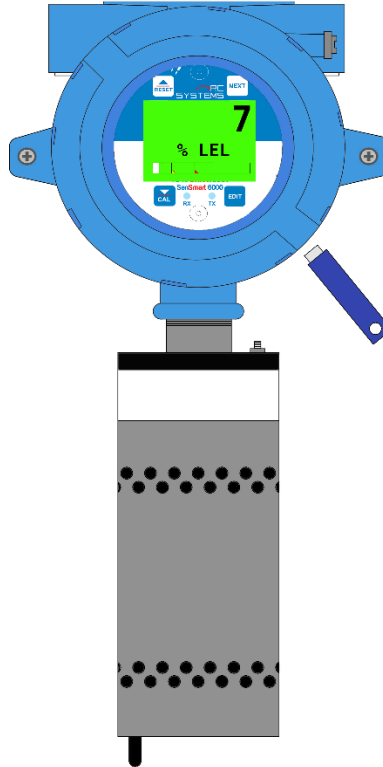
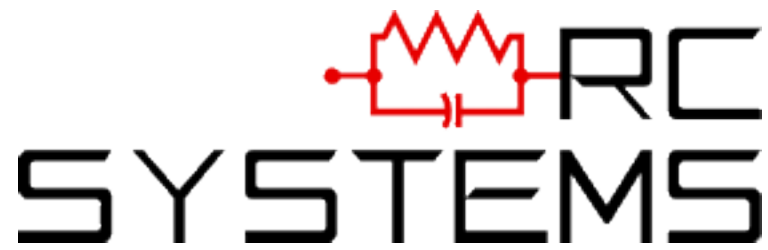

Figure 25 SenSmart 6000M calibration mode

(This page intentionally left blank.)



8621 Hwy. 6, Hitchcock, TX 77563

Phone: 409-986-9800

Fax: 409-986-9880

www.rcsystemsco.com